

ČESKÝ BASEBALL

2018

Extraliga 2018
Extra League 2018

1.	Arrows Ostrava	
2.	Draci Brno	
3.	Eagles Praha	
4.	Kotlářka Praha	
5.	Tempo Titans Praha	
6.	Hroši Brno	
7.	Nuclears Třebíč	
8.	Olympia Blansko	
9.	Skokani Olomouc	
10.	Technika Brno	

Extraliga 2018 - základní část
Extra League 2018 - regular season

	Draci	Arrows	Kotlářka	Eagles	Hroši	Tempo	Nuclears	Olympia	Skokani	Technika	G	W	L	PCT	R	R-
Draci Brno		6 - 3	3 - 1	10 - 0	6 - 4	1 - 0	9 - 7	9 - 0	11 - 6	9 - 2	27	26	1	963	198	66
		10 - 0	6 - 3	6 - 7	7 - 4	5 - 1	6 - 2	12 - 4	11 - 3	3 - 1						
		7 - 0	12 - 6	10 - 6	8 - 3	3 - 1	4 - 0	7 - 0	11 - 1	6 - 1						
Arrows Ostrava	3 - 6		8 - 9	9 - 7	6 - 2	3 - 1	9 - 1	12 - 2	15 - 0	4 - 2	27	22	5	815	235	101
	0 - 10		14 - 9	13 - 6	3 - 1	6 - 0	15 - 0	9 - 4	10 - 0	12 - 9						
	0 - 7		9 - 3	10 - 3	4 - 12	6 - 2	6 - 0	16 - 2	16 - 1	17 - 2						
Kotlářka Praha	1 - 3	9 - 8		7 - 12	8 - 7	3 - 2	7 - 4	13 - 0	10 - 0	4 - 3	27	19	8	704	208	115
	3 - 6	9 - 14		11 - 7	1 - 4	6 - 2	11 - 1	4 - 1	10 - 1	14 - 1						
	6 - 12	3 - 9		4 - 3	12 - 0	3 - 10	9 - 3	8 - 1	19 - 1	13 - 0						
Eagles Praha	0 - 10	7 - 9	12 - 7		5 - 4	5 - 0	10 - 1	10 - 5	5 - 3	12 - 2	27	19	8	704	222	117
	7 - 6	6 - 13	7 - 11		1 - 2	10 - 0	4 - 1	12 - 1	11 - 0	15 - 0						
	6 - 10	3 - 10	3 - 4		9 - 2	6 - 3	11 - 1	10 - 0	18 - 7	17 - 5						
Hroši Brno	4 - 6	2 - 6	7 - 8	4 - 5		3 - 2	14 - 4	8 - 2	0 - 5	3 - 2	27	17	10	630	174	108
	4 - 7	1 - 3	4 - 1	2 - 1		4 - 1	17 - 0	7 - 5	11 - 1	15 - 1						
	3 - 8	12 - 4	0 - 12	2 - 9		11 - 3	10 - 6	6 - 2	19 - 4	1 - 0						
Tempo Titans Praha	0 - 1	1 - 3	2 - 3	0 - 5	2 - 3		3 - 1	5 - 8	10 - 4	0 - 2	27	9	18	333	109	128
	1 - 5	0 - 6	2 - 6	0 - 10	1 - 4		0 - 9	13 - 2	9 - 4	8 - 6						
	1 - 3	2 - 6	10 - 3	3 - 6	3 - 11		4 - 3	9 - 10	9 - 1	11 - 3						
Třebíč Nuclears	7 - 9	1 - 9	4 - 7	1 - 10	4 - 14	1 - 3		9 - 3	9 - 3	10 - 6	27	9	18	333	118	191
	2 - 6	0 - 15	1 - 11	1 - 4	0 - 17	9 - 0		2 - 0	10 - 7	3 - 9						
	0 - 4	0 - 6	3 - 9	1 - 11	6 - 10	3 - 4		11 - 5	9 - 8	11 - 1						
Olympia Blansko	0 - 9	2 - 12	0 - 13	5 - 10	2 - 8	8 - 5	3 - 9		7 - 3	0 - 6	27	6	21	222	92	222
	4 - 12	4 - 9	1 - 4	1 - 12	5 - 7	2 - 13	0 - 2		9 - 6	11 - 4						
	0 - 7	2 - 16	1 - 8	0 - 10	2 - 6	10 - 9	5 - 11		3 - 7	5 - 4						
Skokani Olomouc	6 - 11	0 - 15	0 - 10	3 - 5	5 - 0	4 - 10	3 - 9	3 - 7		7 - 1	27	5	22	185	91	257
	3 - 11	0 - 10	1 - 10	0 - 11	1 - 11	4 - 9	7 - 10	6 - 9		4 - 3						
	1 - 11	1 - 16	1 - 19	7 - 18	4 - 19	1 - 9	8 - 9	7 - 3		4 - 1						
Technika Brno	2 - 9	2 - 4	3 - 4	2 - 12	2 - 3	2 - 0	6 - 10	6 - 0	1 - 7		27	3	24	111	77	214
	1 - 3	9 - 12	1 - 14	0 - 15	1 - 15	6 - 8	9 - 3	4 - 11	3 - 4							
	1 - 6	2 - 17	0 - 13	5 - 17	0 - 1	3 - 11	1 - 11	4 - 0	1 - 4							

tučně jsou uvedena domácí utkání
home games are bold

Vývoj úspěšnosti v základní části a nadstavbě Extraligy 2018
 Trend of win-lose in Extra League regular season 2018

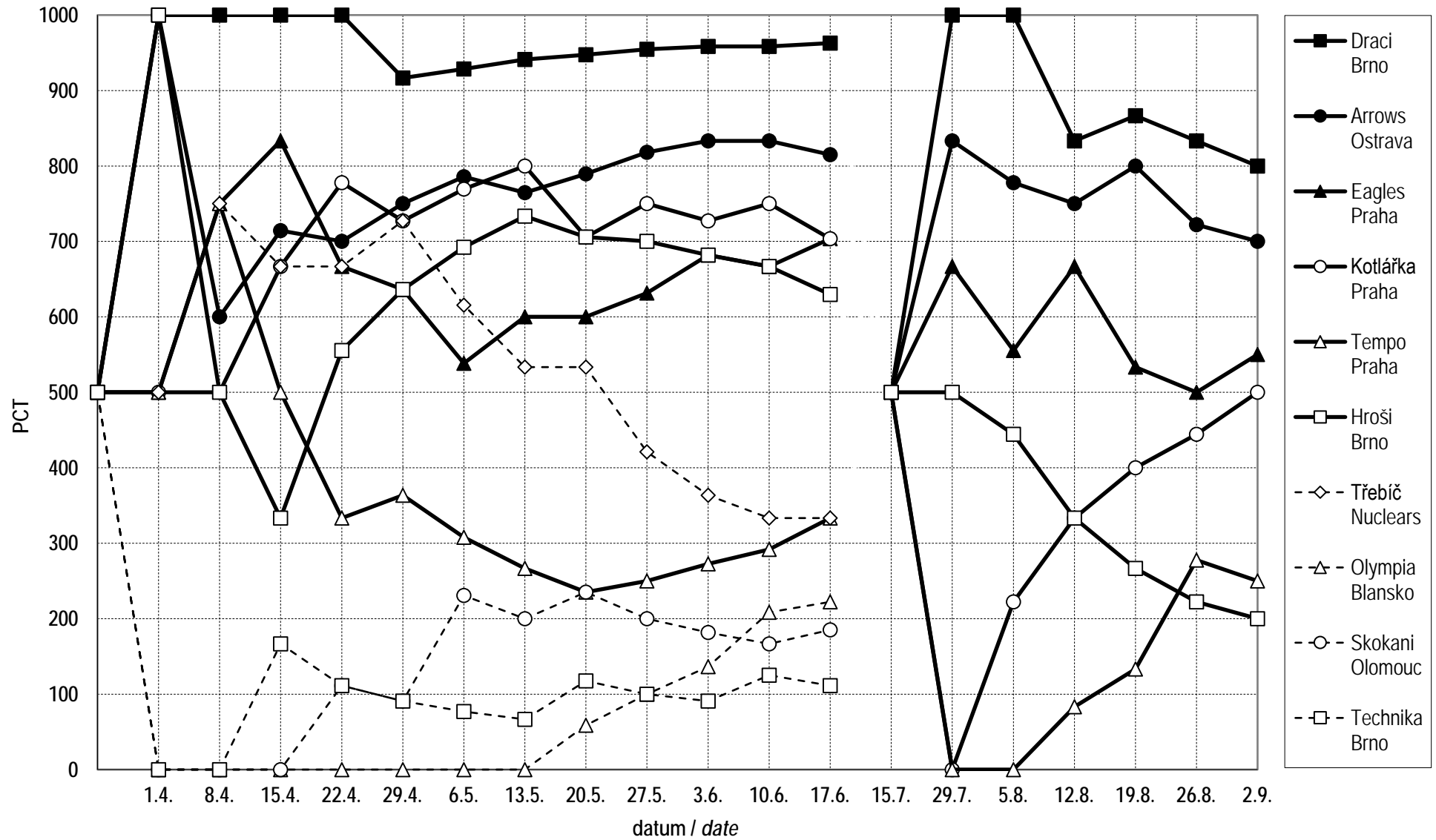

Utání základní části Extraligy 2018 podle rozdílu skóre
Games of Extra League Round Robin 2018, by runs difference

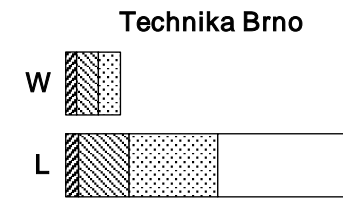
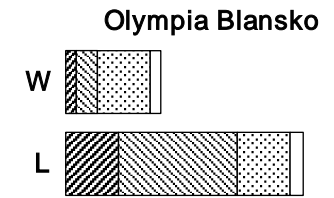
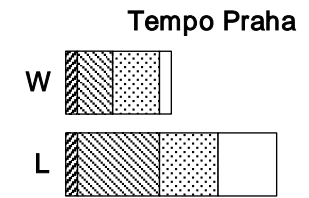
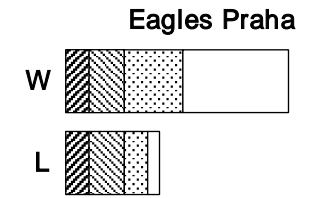
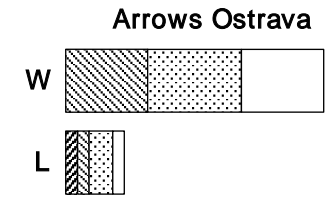
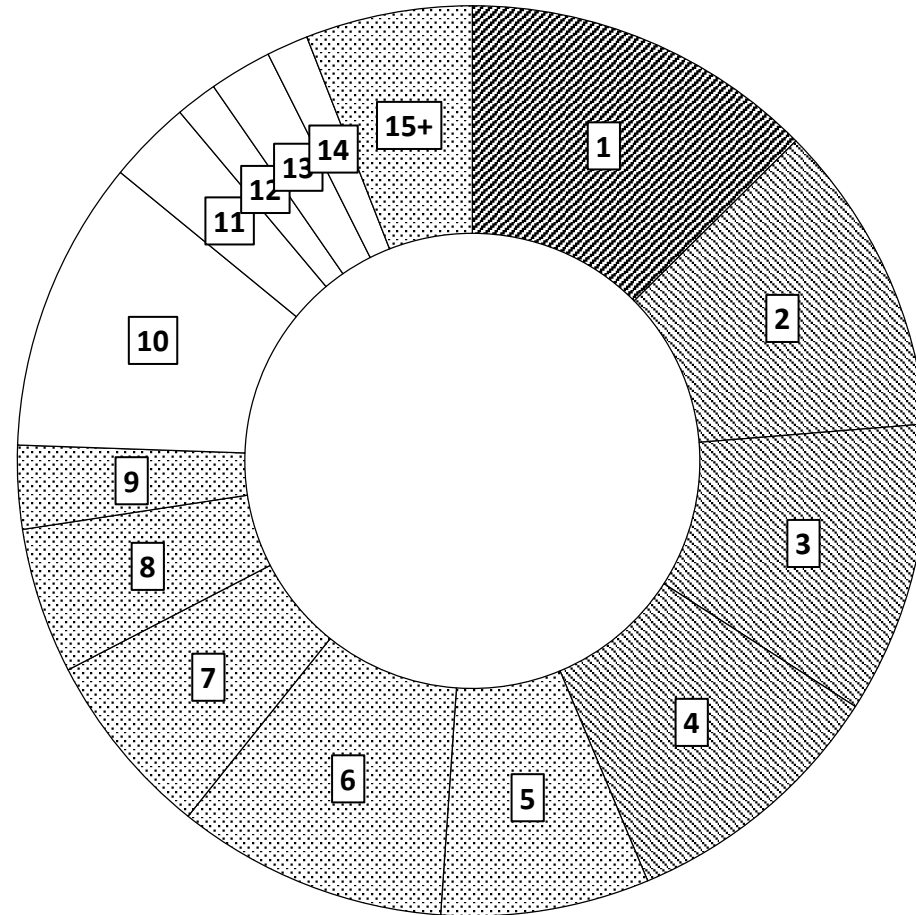
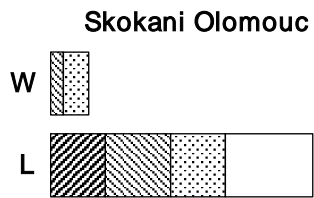
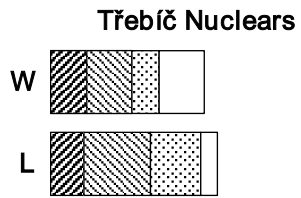
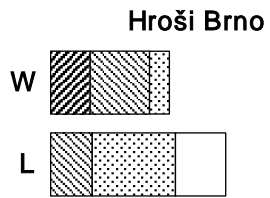
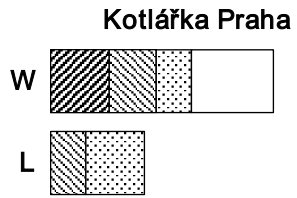
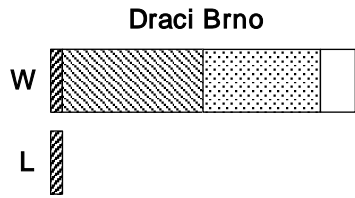

Extraliga 2018 - základní část
Extra League 2018 - round-robin

H	BA (AB»38)	HR	TB
47 Zýma Petr, Eaq	462 Vavruša Daniel, Kot	14 Joyce Terrell, Arr	88 Joyce Terrell, Arr
43 Vavruša Daniel, Kot	457 Hubbard Dondrei, Dra	12 Hejma Matěj, Eaq	88 Zýma Petr, Eaq
39 Hejma Matěj, Eaq	439 Joyce Terrell, Arr	7 Mulhearn Scott, Kot	82 Hejma Matěj, Eaq
39 Juněc Tomáš, Arr	420 Zýma Petr, Eaq	7 Zýma Petr, Eaq	70 Vavruša Daniel, Kot
39 Ondráček Michal, Hro	419 Ondráček Michal, Hro	5 Chlup Marek, Eaq	65 Juněc Tomáš, Arr
37 Hubbard Dondrei, Dra	400 Čech Petr, Dra	5 Malík Jakub, Arr	63 Mulhearn Scott, Kot
37 Mulhearn Scott, Kot	400 Novotný Radim, Arr	4 Grepl Jakub, Arr	61 Chlup Marek, Eaq
36 Čech Petr, Dra	400 Cameron Daniel, Tře	4 Sládek Jakub, Kot	59 Hubbard Dondrei, Dra
36 Joyce Terrell, Arr	394 Hejma Matěj, Eaq	4 Vavruša Daniel, Kot	51 Čech Petr, Dra
35 Dubový Arnošt, Dra	390 Juněc Tomáš, Arr	4 Vykoukal Michael, Arr	51 Malík Jakub, Arr
SLG (AB»38)	BB	OBP (AB+BB+HP+SF»44)	RBI
1073 Joyce Terrell, Arr	22 Vavruša Daniel, Kot	550 Vavruša Daniel, Kot	37 Hejma Matěj, Eaq
828 Hejma Matěj, Eaq	20 Voják Jakub, Sko,Arr	535 Joyce Terrell, Arr	35 Joyce Terrell, Arr
786 Zýma Petr, Eaq	19 Davis Derron, Tře	500 Voják Jakub, Sko,Arr	34 Zýma Petr, Eaq
753 Vavruša Daniel, Kot	17 Joyce Terrell, Arr	500 Cameron Daniel, Tře	30 Mulhearn Scott, Kot
728 Hubbard Dondrei, Dra	17 Vykoukal Michael, Arr	481 Ondráček Michal, Hro	28 Vavruša Daniel, Kot
701 Chlup Marek, Eaq	16 Sandoval David, Eaq	477 Čech Petr, Dra	27 Čech Petr, Dra
662 Malík Jakub, Arr	15 Juněc Tomáš, Arr	467 Vykoukal Michael, Arr	26 Vykoukal Michael, Arr
650 Juněc Tomáš, Arr	15 Menšík Vojtěch, Hro	467 Juněc Tomáš, Arr	25 Hubbard Dondrei, Dra
618 Mulhearn Scott, Kot	15 Mulhearn Scott, Kot	462 Zýma Petr, Eaq	23 3 hráči / players
600 Cameron Daniel, Tře	14 6 hráčů / players	461 Hejma Matěj, Eaq	
SB	R	CG	W
21 Menšík Vojtěch, Hro	37 Vavruša Daniel, Kot	5 Chapman Joel, Sko	7 Novák Jan, Kot
17 Ondráček Michal, Hro	35 Zýma Petr, Eaq	5 Rivera Joe, Tech	7 Satoria Ondřej, Arr
16 Blažka Ondřej, Kot	33 Blažka Ondřej, Kot	4 Rabinowitz Jake, Tem	6 Duffek Tomáš, Eaq
13 Hubbard Dondrei, Dra	33 Dubový Arnošt, Dra	2 Vykoukal Marko, Arr	6 Rabinowitz Jake, Tem
13 Wittig Joseph, Eaq	31 Hejma Matěj, Eaq	1 16 hráčů / players	6 Roemer Wesley, Dra
10 Dubový Arnošt, Dra	30 Juněc Tomáš, Arr		5 Barto Jeffrey, Hro
8 Davis Derron, Tře	30 Mulhearn Scott, Kot		5 Chroust Radim, Dra
8 Němec Jaroslav, Bla	29 Vykoukal Michael, Arr		4 8 hráčů / players
8 Vohánka David, Tem	28 Zýma Michal, Eaq		
7 8 hráčů / players	27 Joyce Terrell, Arr		
SAV	W/L (W+L»3)	IP	K
3 Hussey John, Dra	7-0 Satoria Ondřej, Arr	79,2 Rivera Joe, Tech	96 Rivera Joe, Tech
2 Burkholder Chris, Arr	6-0 Roemer Wesley, Dra	77,0 Chapman Joel, Sko	94 Rabinowitz Jake, Tem
2 Kucin Jan, Hro	5-0 Barto Jeffrey, Hro	77,0 Rabinowitz Jake, Tem	84 Swagerty Stephen, Hro
2 Mc Dowall Ken., Hro	5-0 Chroust Radim, Dra	75,0 Kostka Jakub, Bla	74 Novák Jan, Kot
2 Ondra Tomáš, Arr	4-0 Bokaj Boris, Arr	64,0 Novák Jan, Kot	62 Gallardo August, Tech
1 20 hráčů / players	4-0 Furko Ondřej, Dra	63,1 Brebner Jackson, Kot	60 Thurber Taylor, Eaq
	4-0 Sobotka Michal, Dra	62,2 Swagerty Stephen, Hro	59 Mc Dowall Ken., Hro
	3-0 Dupal Štěpán, Kot	61,1 Minařík Marek, Tem	55 Minařík Marek, Tem
	4-1 Ondra Tomáš, Arr	60,2 Hlouch Lukáš, Tře	54 Roemer Wesley, Dra
	7-2 Novák Jan, Kot	59,2 Duffek Tomáš, Eaq	53 Satoria Ondřej, Arr
ERA (IP»16,0)	PO	A	FA (PO+A+E»42)
0,52 Dupal Štěpán, Kot	223 Homolka Jan, Eaq	90 Van der Linden N, Sko	208-0 Čech Petr, Dra
0,55 Barto Jeffrey, Hro	223 Juněc Tomáš, Arr	83 Menšík Vojtěch, Hro	48-0 Chapman Joel, Sko
0,76 Hussey John, Dra	213 Zelenka Martin, Tem	72 Vohánka David, Tem	44-0 Ondráček Michal, Hro
0,92 Roemer Wesley, Dra	209 Vavruša Daniel, Kot	67 Davis Derron, Tře	992 Utěšený Jan, Sko
0,94 Chroust Radim, Dra	190 Čech Petr, Dra	66 Ondráček Jakub, Hro	992 Kočí Michal, Tech
0,97 Minařík Petr, Dra	182 Kremláček Mich., Hro	65 Hajtmar Jakub, Dra	992 Juněc Tomáš, Arr
1,06 Burkholder Chris, Arr	170 Gottschall Mário, Tech	64 Kostka Jakub, Bla	990 Voják Jakub, Sko,Arr
1,33 Furko Ondřej, Dra	158 Vykoukal Michael, Arr	64 Mulhearn Scott, Kot	990 Kremláček Mich., Hro
1,81 Rivera Joe, Tech	150 Sandoval David, Eaq	61 Zýma Petr, Eaq	989 Šusta Petr, Tem
1,85 Green Reece, Tře	148 Ue Natsuhiko, Bla	59 2 hráči / players	987 Vašek Jakub, Tech

Extraliga 2018 - základní část
Extra League 2018 - round-robin

pákař / <i>hitter</i>	H	AB	BA	nadhazovač/ <i>pitcher</i>	ER	IP	ERA	polář / <i>fielder</i>	PO	A	E	FA
1 Vavruša Daniel, Kot	43	93	462	1 Dupal Štěpán, Kot	1	17,1	0,52	1 Čech Petr, Dra	190	18	-	1000
2 Hubbard Dondrei, Dra	37	81	457	2 Barto Jeffrey, Hro	2	32,2	0,55	Chapman Joel, Sko	36	12	-	1000
3 Joyce Terrell, Arr	36	82	439	3 Hussey John, Dra	3	35,1	0,76	Ondráček Michal, Hro	43	1	-	1000
4 Zýma Petr, Eag	47	112	420	4 Roemer Wesley, Dra	5	48,2	0,92	4 Utěšený Jan, Sko	120	8	1	992
5 Ondráček Michal, Hro	39	93	419	5 Chroust Radim, Dra	5	48,0	0,94	5 Kočí Michal, Tech	114	11	1	992
6 Čech Petr, Dra	36	90	400	6 Minařík Petr, Dra	4	37,0	0,97	6 Juněk Tomáš, Arr	223	14	2	992
Novotný Radim, Arr	26	65	400	7 Burkholder Chris., Arr	2	17,0	1,06	7 Voják Jakub, Sko,Arr	84	18	1	990
Cameron Daniel, Tře	22	55	400	8 Furko Ondřej, Dra	3	20,1	1,33	8 Kremláček Michael, Hro	182	13	2	990
9 Hejma Matěj, Eag	39	99	394	9 Rivera Joe, Tech	16	79,2	1,81	9 Šusta Petr, Tem	77	13	1	989
10 Juněk Tomáš, Arr	39	100	390	10 Green Reece, Tře	9	43,2	1,85	10 Vašek Jakub, Tech	74	2	1	987
11 Malík Jakub, Arr	30	77	390	11 Rabinowitz Jake, Tem	16	77,0	1,87	11 Vavruša Daniel, Kot	209	15	4	982
12 Vykoukal Michael, Arr	32	84	381	12 Brebner Jackson, Kot	15	63,1	2,13	12 Hlouch Lukáš, Tře	32	23	1	982
13 Wittig Joseph, Eag	28	76	368	13 Bokaj Boris, Arr	7	29,0	2,17	Kovařík Jiří, Sko	40	15	1	982
14 Mulhearn Scott, Kot	37	102	363	14 Minařík Marek, Tem	15	61,1	2,20	14 Budský Pavel, Dra	147	15	3	982
15 Chlup Marek, Eag	30	87	345	15 Thurber Taylor, Eag	13	52,0	2,25	15 Sklenář David, Tře	48	5	1	981
16 Kollár Martin, Hro	27	79	342	16 Mc Dowall Kenneth, Hro	15	57,0	2,37	16 Ue Natsuhiko, Bla	148	45	4	980
17 Navrátil Aleš, Arr	34	100	340	17 Satoria Ondřej, Arr	15	55,0	2,45	17 Homolka Jan, Eag	223	13	5	979
18 Hajtmar Jakub, Dra	28	83	337	18 Ercoli Lukáš, Kot	9	28,1	2,86	18 Hejma Matěj, Eag	45	2	1	979
19 Tsurumaki Rio, Kot	16	48	333	19 Ondra Tomáš, Arr	13	38,0	3,08	19 Vykoukal Michael, Arr	158	10	4	977
20 Homolka Jan, Eag	32	97	330	20 Novák Jan, Kot	22	64,0	3,09	20 Ondráček Jakub, Hro	50	66	3	975
21 Polanský Tomáš, Dra	25	76	329	21 Hlouch Lukáš, Tře	21	60,2	3,12	21 Chroust Přemek, Dra	67	5	2	973
22 Dubový Arnošt, Dra	35	108	324	22 Duffek Tomáš, Eag	22	59,2	3,32	22 Dvořák Martin, Hro	119	12	4	970
23 Menšík Vojtěch, Hro	33	105	314	23 Wittig Joseph, Eag	11	27,0	3,67	23 Trunkát Lukáš, Hro	110	13	4	969
Trunkát Lukáš, Hro	22	70	314	24 Vykoukal Marko, Arr	17	41,0	3,73	24 Zelenka Martin, Tem	213	28	8	968
25 Voják Jakub, Sko,Arr	21	67	313	25 Havlíček Štěpán, Bla	17	36,2	4,17	25 Sandoval David, Eag	150	22	6	966
26 Pojer Jan, Eag	25	80	313	26 Dijck Rick, Eag	14	30,0	4,20	26 Gottschall Mário, Tech	170	26	7	966
27 Lázníček Matěj, Sko	30	97	309	27 Chapman Joel, Sko	37	77,0	4,32	Wittig Joseph, Eag	19	37	2	966
28 Moštěk Filip, Dra	21	68	309	28 Lukačka Martin, Tem	16	33,0	4,36	28 Bužga Vojtěch, Eag	15	40	2	965
29 Pomazal Vojtěch, Tech	12	39	308	29 Swagerty Stephen, Hro	31	62,2	4,45	29 Šůcha Matěj, Kot	51	2	2	964
30 Němec Jaroslav, Bla	29	95	305	30 Bareš Martin, Hro	16	31,0	4,65	30 Aubrecht Ivan, Kot	74	3	3	963
31 Sova Marek, Sko	20	66	303	31 Kostka Jakub, Bla	39	75,0	4,68	31 Jelínek Tomáš, Bla	50	-	2	962
32 Truesdale Joseph, Kot	20	67	299	32 Sobotka Michal, Dra	13	24,2	4,74	Sládek Jakub, Kot	48	2	2	962
33 Schneider Martin, Dra	19	64	297	33 Gallardo August, Tech	30	51,0	5,29	33 Menšík Vojtěch, Hro	38	83	5	960
34 Sázkavský Richard, Tech	26	88	295	34 Nevěřil David, Tem	23	35,0	5,91	34 Mužík Martin, Kot	61	9	3	959
Hamža Ivan, Tře	13	44	295	35 Kočí Michal, Tech	26	38,1	6,10	35 Němec Jaroslav, Bla	64	5	3	958
36 Davis Derron, Tře	28	96	292	36 Vavruša Jiří, Kot	17	24,2	6,20	36 Poledna Martin, Sko	43	2	2	957
37 Havlíček Štěpán, Bla	13	45	289	37 Brandon Valentin, Tře	13	18,2	6,27	37 Ramirez Devon, Arr	34	9	2	956
38 Sandoval David, Eag	21	74	284	38 Tauš Václav, Tře	14	19,1	6,52	38 Nevěřil David, Tem	46	57	5	954
39 Chroust Přemek, Dra	24	85	282	39 Blažek Aleš, Bla	14	18,2	6,75	39 Kuřílek Zdeněk, Tře	40	1	2	953
Nevěřil David, Tem	24	85	282	40 Pruša Michal, Tře	38	46,1	7,38	40 Urbánek Jan, Tře	96	6	5	953
41 Zýma Michal, Eag	31	110	282	41 Kohout Michal, Sko	25	28,1	7,94	41 Pláteník Matěj, Tem	96	4	5	952
42 Grepl Jakub, Arr	24	86	279	Farkaš David, Bla	25	27,2	8,13	42 Hamža Ivan, Tře	93	4	5	951
43 Claus Filip, Hro	25	90	278	43 Viera Alejandro, Tře	18	19,2	8,24	43 Zýma Michal, Eag	66	50	6	951
44 Cipolla Anthony, Arr	21	76	276	44 Satoria Matěj, Arr	19	19,1	8,84	44 Pejchal Kamil, Tře	96	18	6	950
45 Brebner Jackson, Kot	19	69	275	45 Mik Petr, Sko	22	21,1	9,28	Brebner Jackson, Kot	34	23	3	950
46 Aubrecht Ivan, Kot	20	73	274	46 Veselý Lukáš, Sko	30	23,0	11,74	46 Farkaš David, Bla	41	14	3	948
47 Gottschall Mário, Tech	26	95	274	47 Yasuda Akimasa, Bla	58	42,1	12,33	47 Kubica Jakub, Arr	23	50	4	948
48 Budský Pavel, Dra	21	78	269	Hegr Ondřej, Eag	0	9,0	0,00	48 Šustal Jiří, Bla	107	2	6	948
Kremláček Michael, Hro	21	78	269	Němec Jaroslav, Bla	0	5,0	0,00	49 Regner Robert, Tech	22	24	3	939
50 Rabinowitz Jake, Tem	16	60	267	Čapka Filip, Dra	0	4,1	0,00	50 Blažek Aleš, Bla	56	4	4	938
51 Peřina Šimon, Tem	22	83	265	Sandoval David, Eag	0	3,0	0,00	51 Hajtmar Jakub, Dra	39	65	7	937
52 Chapman Joel, Sko	10	38	263	Bužga Vojtěch, Eag	0	2,1	0,00	52 Claus Filip, Hro	13	44	4	934
53 Sládek Jakub, Kot	13	51	255	Kalábek Martin, Dra	0	2,0	0,00	53 Cameron Daniel, Tře	54	17	5	934
54 Riegger Daniel, Tem	23	91	253	Kollár Martin, Hro	0	2,0	0,00	54 Kollár Martin, Hro	49	6	4	932

Extraliga 2018 - základní část
Extra League 2018 - round-robin

pákař / hitter	H	AB	BA	nadhazovač/pitcher	ER	IP	ERA	pořadí / fielder	PO	A	E	FA
55 Menšík Matěj, Hro	26	103	252	Mulhearn Scott, Kot	0	1,1	0,00	Sázavský Richard, Tech	52	3	4	932
56 Ue Natsuhiko, Bla	26	104	250	Cameron Daniel, Tře	0	1,0	0,00	56 Van der Linden Nathan, !	43	90	10	930
Doležal Dominik, Tře	23	92	250	Kohoutek Michal, Bla	0	1,0	0,00	57 Mulhearn Scott, Kot	40	64	8	929
Pláteník Matěj, Tem	15	60	250	Mencl Pavel, Eag	0	1,0	0,00	Křivánek Miroslav, Tře	30	48	6	929
Kucin Jan, Hro	14	56	250	Regner Martin, Tech	0	1,0	0,00	59 Lázníček Matěj, Sko	58	1	5	922
Vavruša Jiří, Kot	13	52	250	Schneider Martin, Dra	1	9,0	1,00	60 Kelar Sebastian, Tech	28	54	7	921
61 Blažka Ondřej, Kot	25	101	248	Vohánka David, Tem	1	5,2	1,59	61 Sova Marek, Sko	52	4	5	918
62 Lincoln Dominique, Tech	17	69	246	Josefus Lukáš, Eag	2	10,2	1,69	62 Grepel Jakub, Arr	38	59	9	915
63 Dvořák Martin, Hro	14	57	246	Derhak Alexander, Hro	2	10,1	1,74	63 Kohoutek Michal, Bla	35	37	7	911
64 Kutílek Zdeněk, Tře	16	66	242	Kucin Jan, Hro	3	15,1	1,76	64 Riegger Daniel, Tem	21	20	4	911
65 Kočí Michal, Tech	14	58	241	Ramirez Devon, Arr	2	9,1	1,93	65 Schwarz Ondřej, Sko	46	31	8	906
66 Van der Linden N., Sko	22	92	239	Peřina Šimon, Tem	1	4,0	2,25	66 Davis Derron, Tře	35	67	11	903
67 Jelínek Tomáš, Bla	16	68	235	Šmidt Viktor, Eag	4	11,2	3,09	67 Vohánka David, Tem	60	72	15	898
68 Šůcha Matěj, Kot	19	83	229	Tatar Martin, Hro	5	13,2	3,29	68 Zýma Petr, Eag	24	61	10	895
69 Lošťák David, Bla	16	70	229	Vašourek Jan, Dra	3	7,2	3,52	69 Cipolla Anthony, Arr	39	59	12	891
70 Rejman Marek, Tem	13	57	228	Padyšák Daniel, Kot	5	11,0	4,09	70 Schneider Martin, Dra	29	43	9	889
71 Farkaš David, Bla	18	81	222	Kvapil Ondřej, Eag	5	10,2	4,22	Borůvka Jakub, Sko	27	13	5	889
Kabeš Ladislav, Bla	10	45	222	Sobotka Jan, Tem	3	6,0	4,50	Rabinowitz Jake, Tem	11	29	5	889
73 Ramirez Devon, Arr	14	64	219	Wechsler Adam, Hro	2	3,1	5,40	73 Lošťák David, Bla	40	36	10	884
74 Šulc Radek, Eag	13	60	217	Jelínek Tomáš, Bla	10	15,2	5,74	Hrubý Jiří, Bla	12	26	5	884
75 Kubica Jakub, Arr	14	65	215	Schwarz Ondřej, Sko	4	6,0	6,00	75 Klimeš Michal, Tech	39	29	9	883
76 Ondráček Jakub, Hro	20	93	215	Dvořák Roman, Tře	2	3,0	6,00	76 Hubbard Dondrei, Dra	48	27	10	882
77 Hajtmar Adam, Dra	9	42	214	Joyce Terrell, Arr	8	11,1	6,35	77 Kostka Jakub, Bla	35	64	14	876
Střítecký Martin, Tech	9	42	214	Cihlář Josef, Kot	4	5,2	6,35	78 Krejčířik Marek, Tře	21	25	8	852
79 Novotný Jiří, Tře	15	71	211	Střítecký Martin, Tech	5	6,2	6,75	79 Zdražil Martin, Sko	23	49	15	828
80 Pejchal Kamil, Tře	15	72	208	Král Michael, Kot	8	10,1	6,97	Bužga Matěj, Tem	39	1	-	1000
81 Zelenka Martin, Tem	21	102	206	Nováček Milan, Tech	10	12,1	7,30	Chlup Marek, Eag	39	1	-	1000
82 Kovařík Jiří, Sko	13	65	200	Zdražil Martin, Sko	12	13,2	7,90	Rejman Marek, Tem	38	1	-	1000
83 Šustal Jiří, Bla	11	56	196	Šimek Jiří, Sko	13	14,0	8,36	Dubový Arnošt, Dra	37	-	-	1000
84 Derhak Alexander, Hro	8	41	195	Čuhel Lubomír, Tem	5	5,0	9,00	Moštěk Filip, Dra	36	-	-	1000
87 Kohoutek Michal, Bla	12	62	194	Bečka Vojtěch, Tem	1	1,0	9,00	Joyce Terrell, Arr	30	4	-	1000
88 Kostka Jakub, Bla	11	58	190	Kaplan Jakub, Arr	1	1,0	9,00	Truesdale Joseph, Kot	27	1	-	1000
89 Vohánka David, Tem	20	106	189	Ue Natsuhiko, Bla	1	1,0	9,00	Lincoln Dominique, Tech	26	1	-	1000
90 Šusta Petr, Tem	8	45	178	Van der Linden N., Sko	16	14,2	9,82	Kucin Jan, Hro	22	2	-	1000
91 Sklenář David, Tře	14	84	167	Klimeš Michal, Tech	9	7,1	11,05	Malík Jakub, Arr	22	2	-	1000
Utěšený Jan, Sko	7	42	167	Just Daniel, Tech	7	5,2	11,12	Hajtmar Adam, Dra	21	2	-	1000
93 Křivánek Miroslav, Tře	12	73	164	Mencl Matěj, Eag	3	2,0	13,50	Rivera Joe, Tech	2	18	-	1000
94 Bužga Matěj, Tem	11	67	164	Večerka Viktor, Dra	3	2,0	13,50	Minařík Petr, Dra	12	7	-	1000
95 Vašek Jakub, Tech	9	55	164	Výbora Jan, Eag	2	1,1	13,50	Řehůřek Lukáš, Dra	17	2	-	1000
96 Klimeš Michal, Tech	13	83	157	Lincoln Dominique, Tech	4	2,1	15,43	Kachurka Aliaksei, Eag	16	1	-	1000
97 Schwarz Ondřej, Sko	11	73	151	Bláha Vojtěch, Tech	9	5,0	16,20	Kalábek Martin, Dra	16	1	-	1000
98 Roemer Wesley, Dra	6	40	150	Vávra Robin, Tře	6	3,1	16,20	Kovala Tomáš, Arr	7	10	-	1000
99 Bužga Vojtěch, Eag	6	41	146	Žondra Tomáš, Hro	5	2,2	16,88	Kaplan Jakub, Arr	11	3	-	1000
Krejčířik Marek, Tře	6	41	146	Schwarz Pavel, Sko	16	7,2	18,78	Kučera Ivo, Bla	14	-	-	1000
101 Borůvka Jakub, Sko	7	48	146	Burian Radek, Tech	15	6,0	22,50	Georgiev Georgi, Tech	10	2	-	1000
Nepomucký Aleš, Tem	7	48	146	Lázníček Matěj, Sko	5	2,0	22,50	Navrátil Aleš, Arr	12	-	-	1000
103 Blažek Aleš, Bla	6	42	143	Tellez Yasser, Tech	6	2,0	27,00	Tauš Václav, Tře	4	6	-	1000
104 Zdražil Martin, Sko	10	79	127	Doležal Dominik, Tře	8	2,1	30,86	Vašourek František, Hro	8	2	-	1000
105 Hrubý Jiří, Bla	7	59	119	Garcia Jesus, Tře	9	2,1	34,71	Laube Martin, Eag	9	-	-	1000
106 Brabec Matěj, Tech	6	53	113	Blažek Šimon, Eag	4	1,0	36,00	Kohout Michal, Sko	1	6	-	1000
107 Kelar Sebastian, Tech	7	66	106	Janík Karel, Tech	3	0,2	40,50	Machačka Zdeněk, Eag	6	1	-	1000
108 Regner Robert, Tech	6	58	103	Výbora Jonáš, Eag	2	0,1	54,00	Adamus Jindřich, Sko	5	1	-	1000
109 Urbánek Jan, Tře	3	39	077	Davis Derron, Tře	7	0,2	94,50	Ondra Tomáš, Arr	1	5	-	1000
110 Poledna Martin, Sko	3	51	059	Kořata Ondřej, Sko,Arr	7	0,2	94,50	Satoria Matěj, Arr	6	-	-	1000

Extraliga 2018 - základní část
Extra League 2018 - round-robin

pálkař / hitter	H	AB	BA	nadhazovač/pitcher	ER	IP	ERA	polář / fielder	PO	A	E	FA
Boda Michal, Hro	1	1	1000	Šebela Ondřej, Bla	1	0,0	x	Schiefert Patrik, Tem	6	-	-	1000
Uhnavý Jakub, Eag	1	1	1000					Šuran Martin, Tem	6	-	-	1000
Vašourek Jan, Dra	2	3	667					Bareš Martin, Hro	2	3	-	1000
Novák Jan, Kot	2	4	500					Bláha Vojtěch, Tech	2	3	-	1000
Škaroupka Martin, Tech	2	4	500					Daněk Filip, Sko	5	-	-	1000
Minařík Marek, Tem	1	2	500					Ondroušek Dan, Hro	4	1	-	1000
Satoria Matěj, Arr	1	2	500					Ercoli Lukáš, Kot	2	2	-	1000
Šimek Jiří, Sko	1	2	500					Fusek Aleš, Sko	2	2	-	1000
Winkler David, Tře	1	2	500					Mánek Jakub, Hro	4	-	-	1000
Ondra Tomáš, Arr	3	8	375					Barto Jeffrey, Hro	-	3	-	1000
Kalábek Martin, Dra	12	33	364					Dupal Štěpán, Kot	1	2	-	1000
Bláha Vojtěch, Tech	2	6	333					Hegr Ondřej, Eag	2	1	-	1000
Kachurka Aliaksei, Eag	4	13	308					Jasanský Alfréd, Kot	2	1	-	1000
Sázavský Oliver, Tech	9	30	300					Košata Ondřej, Sko,Arr	3	-	-	1000
Klanica Martin, Dra	3	10	300					Sobotka Michal, Dra	1	2	-	1000
Johnson Julian, Tech	8	27	296					Šmidt Viktor, Eag	1	2	-	1000
Laube Martin, Eag	8	27	296					Vašourek Jan, Dra	2	1	-	1000
Jelínek Zdeněk, Bla	5	17	294					Burkholder Chris., Arr	-	2	-	1000
Mužík Martin, Kot	7	24	292					Derhak Alexander, Hro	-	2	-	1000
Ešmír Michal, Tře	2	7	286					Dijck Rick, Eag	-	2	-	1000
Georgiev Georgi, Tech	2	7	286					Josefus Lukáš, Eag	1	1	-	1000
Kaplan Jakub, Arr	7	25	280					Kvapil Ondřej, Eag	-	2	-	1000
Tellez Yasser, Tech	5	18	278					Matějka Filip, Tech	2	-	-	1000
Aschermann Martin, Eag	6	22	273					Sobotka Jakub, Tem	2	-	-	1000
Bečka Vojtěch, Tem	6	22	273					Šimek Jiří, Sko	-	2	-	1000
Adamus Jindřich, Sko	3	11	273					Tatar Martin, Hro	1	1	-	1000
Antoš Ondřej, Sko	9	36	250					Winkler David, Tře	1	1	-	1000
Gallardo August, Tech	4	16	250					Burian Radek, Tech	-	1	-	1000
Zhupanin Vasil, Sko	2	8	250					Čapka Filip, Dra	-	1	-	1000
Dupal Štěpán, Kot	1	4	250					Dvořák Roman, Tře	-	1	-	1000
Martinez Christopfer, Tem	8	33	242					Král Michael, Kot	-	1	-	1000
Müller Michal, Kot	6	25	240					Nováček Milan, Tech	-	1	-	1000
Blažek Šimon, Eag	6	26	231					Schwarz Pavel, Sko	1	-	-	1000
Kučera Ivo, Bla	4	18	222					Vrba Vojtěch, Sko	1	-	-	1000
Černý Daniel, Arr	2	9	222					Wechsler Adam, Hro	1	-	-	1000
Schiefert Patrik, Tem	2	9	222					Střítecký Martin, Tech	33	6	1	975
Smola Filip, Kot	5	23	217					Bečka Vojtěch, Tem	20	16	1	973
Červinka Martin, Dra	6	28	214					Vančura Jakub, Kot	35	1	1	973
Puš Jáchym, Kot	7	33	212					Menšík Matěj, Hro	30	-	1	968
Kovala Tomáš, Arr	4	21	190					Aschermann Martin, Eag	26	-	1	963
Ondroušek Dan, Hro	2	11	182					Nepomucký Aleš, Tem	25	1	1	963
Řehůrek Lukáš, Dra	2	11	182					Peřina Šimon, Tem	25	1	1	963
Mánek Jakub, Hro	2	12	167					Kříž Jaroslav, Bla	20	3	1	958
Goleš Petr, Tech	2	13	154					Pojer Jan, Eag	19	2	1	955
Hlouch Lukáš, Tře	3	20	150					Satoria Ondřej, Arr	6	15	1	955
Šmoldas Martin, Arr	3	20	150					Duffek Tomáš, Eag	3	17	1	952
Touron Luis, Tře	4	27	148					Furko Ondřej, Dra	16	3	1	950
Padyšák Daniel, Kot	3	26	115					Mc Dowall Kenneth, Hro	3	16	1	950
Vávra Robin, Tře	4	35	114					Blažka Ondřej, Kot	34	2	2	947
Furko Ondřej, Dra	1	9	111					Havlíček Štěpán, Bla	10	7	1	944
Vašourek František, Hro	1	9	111					Šulc Radek, Eag	4	12	1	941
Vančura Jakub, Kot	2	19	105					Roemer Wesley, Dra	15	15	2	938
Mc Dowall Kenneth, Hro	1	11	091					Touron Luis, Tře	24	3	2	931
Yasuda Akimasa, Bla	1	13	077					Vávra Robin, Tře	10	17	2	931

Extraliga 2018 - základní část
Extra League 2018 - round-robin

pálkař / hitter	H	AB	BA	nadhazovač/pitcher	ER	IP	ERA	polář / fielder	PO	A	E	FA
Kříž Jaroslav, Bla	1	17	059					Thurber Taylor, Eag	4	9	1	929
Šebela Ondřej, Bla	-	10	000					Müller Michal, Kot	8	17	2	926
Křivánek Michal, Tře	-	8	000					Doležal Dominik, Tře	35	2	3	925
Mik Petr, Sko	-	8	000					Červinka Martin, Dra	10	26	3	923
Štingl Jan, Tech	-	8	000					Novotný Radim, Arr	21	15	3	923
Šuran Martin, Tem	-	8	000					Bokaj Boris, Arr	2	10	1	923
Vrba Vojtěch, Sko	-	7	000					Johnson Julian, Tech	12	-	1	923
Daněk Filip, Sko	-	6	000					Smola Filip, Kot	9	14	2	920
Lukačka Martin, Tem	-	6	000					Goleš Petr, Tech	16	6	2	917
Matějka Filip, Tech	-	6	000					Kabeš Ladislav, Bla	17	5	2	917
Rivera Joe, Tech	-	6	000					Gallardo August, Tech	4	6	1	909
Mencl Pavel, Eag	-	5	000					Křivánek Michal, Tře	4	6	1	909
Svoboda Jakub, Tech	-	5	000					Klanica Martin, Dra	3	6	1	900
Fusek Aleš, Sko	-	4	000					Novotný Jiří, Tře	16	1	2	895
Minařík Petr, Dra	-	4	000					Padyšák Daniel, Kot	5	12	2	895
Schwarz Pavel, Sko	-	4	000					Tsurumaki Rio, Kot	20	13	4	892
Thurber Taylor, Eag	-	4	000					Hussey John, Dra	3	5	1	889
Výbora Jonáš, Eag	-	4	000					Puš Jáchym, Kot	8	23	4	886
Jasanský Alfréd, Kot	-	3	000					Antoš Ondřej, Sko	21	2	3	885
Košata Ondřej, Sko,Arr	-	3	000					Swagerty Stephen, Hro	3	11	2	875
Burian Radek, Tech	-	2	000					Jelínek Zdeněk, Bla	7	-	1	875
Just Daniel, Tech	-	2	000					Tellez Yasser, Tech	3	4	1	875
Libiak Jozef, Tře	-	2	000					Vavruša Jiří, Kot	9	25	5	872
Machačka Zdeněk, Eag	-	2	000					Blažek Šimon, Eag	9	11	3	870
Novotný Tomáš, Eag	-	2	000					Novák Jan, Kot	2	11	2	867
Regner Martin, Tech	-	2	000					Yasuda Akimasa, Bla	7	6	2	867
Sitár Jaroslav, Hro	-	2	000					Sázavský Oliver, Tech	19	-	3	864
Tauš Václav, Tře	-	2	000					Chroust Radim, Dra	3	3	1	857
Dvořák Roman, Tře	-	1	000					Šebela Ondřej, Bla	3	3	1	857
Ercoli Lukáš, Kot	-	1	000					Polanský Tomáš, Dra	5	28	6	846
Green Reece, Tře	-	1	000					Martinez Chris., Tem	6	14	4	833
Imramovský Jan, Eag	-	1	000					Sitár Jaroslav, Hro	9	1	2	833
Mikš Marián, Tem	-	1	000					Regner Martin, Tech	5	-	1	833
Nováček Milan, Tech	-	1	000					Vykoukal Marko, Arr	3	2	1	833
Sobotka Jakub, Tem	-	1	000					Pomazal Vojtěch, Tech	7	26	7	825
Švábenský Vojta, Tech	-	1	000					Lukačka Martin, Tem	5	4	2	818
Zajíček Adam, Tem	-	1	000					Šmoldas Martin, Arr	8	5	3	813
								Green Reece, Tře	2	6	2	800
								Veselý Lukáš, Sko	1	3	1	800
								Pruša Michal, Tře	1	6	2	778
								Minařík Marek, Tem	5	17	7	759
								Brabec Matěj, Tech	9	19	9	757
								Mik Petr, Sko	4	5	3	750
								Just Daniel, Tech	-	3	1	750
								Viera Alejandro, Tře	1	2	1	750
								Brandon Valentin, Tře	2	5	3	700
								Svoboda Jakub, Tech	1	1	1	667
								Zhupanin Vasil, Sko	2	5	4	636
								Ešmír Michal, Tře	2	1	2	600
								Štingl Jan, Tech	1	-	1	500
								Garcia Jesus, Tře	-	-	1	000
								Sobotka Jan, Tem	-	-	1	000
								Škaroupka Martin, Tech	-	-	1	000



Extraliga 2018 - základní část

Extra League 2018 - regular season

hráč <i>player</i>	pálka / <i>batting</i>																	pole / <i>fielding</i>						nadhoz / <i>pitching</i>									
	G	AB	H	2B	3B	HR	SO	BB	HP	SH	SF	RBI	SB	CS	R	BA	SLG	OBP	PO	A	E	FA	G	CG	W	L	SV	IP	K	R-	ER	WL	ERA
Draci Brno	27	913	287	55	14	5	142	103	25	10	23	168	54	15	198	314	422	390	717	275	46	956	27	1	26	1	7	239,0	235	66	40	963	1,51
Budský Pavel	24	78	21	6	-	-	16	9	4	-	2	14	-	1	11	269	346	366	147	15	3	982	-	-	-	-	-	-	-	-	-	x	x
Čapka Filip	3	-	-	-	-	-	-	-	-	-	-	-	-	-	-	x	x	x	-	1	-	1000	3	-	1	-	-	4,1	4	1	-	1000	0,00
Čech Petr	25	90	36	6	3	1	4	14	2	-	3	27	1	1	25	400	567	477	190	18	-	1000	-	-	-	-	-	-	-	-	-	x	x
Červinka Martin	7	28	6	-	-	1	3	2	-	-	-	4	1	1	6	214	321	267	10	26	3	923	-	-	-	-	-	-	-	-	-	x	x
Dubový Arnošt	26	108	35	5	3	-	14	11	6	1	1	10	10	3	33	324	426	413	37	-	-	1000	-	-	-	-	-	-	-	-	-	x	x
Furko Ondřej	13	9	1	1	-	-	5	-	-	-	1	1	-	-	1	111	222	100	16	3	1	950	4	-	4	-	-	20,1	17	5	3	1000	1,33
Hajtmar Adam	13	42	9	1	-	-	9	3	-	1	2	10	2	-	4	214	238	255	21	2	-	1000	-	-	-	-	-	-	-	-	-	x	x
Hajtmar Jakub	23	83	28	6	1	1	7	10	1	3	1	19	6	2	21	337	470	411	39	65	7	937	-	-	-	-	-	-	-	-	-	x	x
Hubbard Dondrei	24	81	37	12	2	2	5	3	2	-	6	25	13	-	22	457	728	457	48	27	10	882	-	-	-	-	-	-	-	-	-	x	x
Hussey John	12	-	-	-	-	-	-	-	-	-	-	-	-	-	-	x	x	x	3	5	1	889	12	-	2	-	3	35,1	40	7	3	1000	0,76
Chroust Přemek	26	85	24	2	-	-	6	13	2	-	4	19	3	5	16	282	306	375	67	5	2	973	-	-	-	-	-	-	-	-	-	x	x
Chroust Radim	10	-	-	-	-	-	-	-	-	-	-	-	-	-	-	x	x	x	3	3	1	857	10	-	5	-	-	48,0	51	10	5	1000	0,94
Kalábek Martin	12	33	12	1	1	-	11	-	2	2	1	7	2	-	6	364	455	389	16	1	-	1000	1	-	-	-	-	2,0	3	1	-	x	0,00
Klanica Martin	8	10	3	-	-	-	2	1	-	1	-	1	2	1	2	300	300	364	3	6	1	900	-	-	-	-	-	-	-	-	-	x	x
Minařík Petr	13	4	-	-	-	-	1	-	1	-	-	-	-	-	-	000	000	200	12	7	-	1000	12	-	3	1	1	37,0	30	6	4	750	0,97
Moštěk Filip	22	68	21	4	2	-	15	14	-	1	-	8	7	1	16	309	426	427	36	-	-	1000	-	-	-	-	-	-	-	-	-	x	x
Polanský Tomáš	23	76	25	5	-	-	19	10	2	-	-	9	-	-	10	329	395	420	5	28	6	846	-	-	-	-	-	-	-	-	-	x	x
Roemer Wesley	23	40	6	1	1	-	7	2	-	1	-	2	1	-	5	150	225	190	15	15	2	938	10	1	6	-	1	48,2	54	7	5	1000	0,92
Řehůřek Lukáš	7	11	2	1	-	-	3	-	1	-	-	2	-	-	4	182	273	250	17	2	-	1000	-	-	-	-	-	-	-	-	-	x	x
Schneider Martin	17	64	19	4	1	-	15	9	2	-	2	9	6	-	15	297	391	390	29	43	9	889	6	-	-	-	1	9,0	7	1	1	x	1,00
Sobotka Michal	8	-	-	-	-	-	-	-	-	-	-	-	-	-	-	x	x	x	1	2	-	1000	8	-	4	-	1	24,2	21	18	13	1000	4,74
Vašourek Jan	7	3	2	-	-	-	-	2	-	-	-	1	-	-	1	667	667	800	2	1	-	1000	6	-	1	-	-	7,2	6	6	3	1000	3,52
Večerka Viktor	1	-	-	-	-	-	-	-	-	-	-	-	-	-	-	x	x	x	-	-	-	x	1	-	-	-	-	2,0	2	4	3	x	13,50

Extraliga 2018 - základní část
Extra League 2018 - regular season



hráč <i>player</i>	pálka / <i>batting</i>																pole / <i>fielding</i>						nadhoz / <i>pitching</i>											
	G	AB	H	2B	3B	HR	SO	BB	HP	SH	SF	RBI	SB	CS	R	BA	SLG	OBP	PO	A	E	FA	G	CG	W	L	SV	IP	K	R-	ER	W/L	ERA	
Arrows Ostrava	27	897	295	48	10	36	154	125	15	15	16	197	37	11	235	329	525	413	660	277	42	957	27	5	22	5	7	221,0	184	97	84	815	3,42	
Bokaj Boris	8	-	-	-	-	-	-	-	-	-	-	-	-	-	-	x	x	x	2	10	1	923	8	-	4	-	-	29,0	24	11	7	1000	2,17	
Burkholder Christopfer	6	-	-	-	-	-	-	-	-	-	-	-	-	-	-	x	x	x	-	2	-	1000	6	-	1	-	2	17,0	25	2	2	1000	1,06	
Cipolla Anthony	25	76	21	6	2	1	21	8	3	3	-	6	6	1	22	276	447	368	39	59	12	891	-	-	-	-	-	-	-	-	-	-	x	x
Černý Daniel	5	9	2	1	-	1	3	-	-	-	-	2	-	-	2	222	667	222	-	-	-	x	-	-	-	-	-	-	-	-	-	-	x	x
Grepl Jakub	24	86	24	3	-	4	21	7	1	2	-	15	3	2	22	279	453	340	38	59	9	915	-	-	-	-	-	-	-	-	-	-	x	x
Joyce Terrell	27	82	36	6	2	14	15	17	1	-	1	35	5	-	27	439	1073	535	30	4	-	1000	4	-	1	1	1	11,1	10	8	8	500	6,35	
Juněk Tomáš	27	100	39	11	3	3	17	15	2	-	3	18	-	1	30	390	650	467	223	14	2	992	-	-	-	-	-	-	-	-	-	-	x	x
Kaplan Jakub	13	25	7	-	1	-	9	3	-	1	-	3	1	-	4	280	360	357	11	3	-	1000	1	-	-	-	-	1,0	-	2	1	x	9,00	
Košata Ondřej	2	-	-	-	-	-	-	2	-	-	-	-	-	-	1	x	x	1000	-	-	-	x	-	-	-	-	-	-	-	-	-	-	x	x
Kovala Tomáš	11	21	4	-	-	-	4	3	-	-	-	1	-	-	4	190	190	292	7	10	-	1000	-	-	-	-	-	-	-	-	-	-	x	x
Kubica Jakub	24	65	14	-	-	-	13	14	-	2	-	12	2	1	15	215	215	354	23	50	4	948	-	-	-	-	-	-	-	-	-	-	x	x
Malík Jakub	22	77	30	4	1	5	11	8	1	-	-	23	2	-	18	390	662	453	22	2	-	1000	-	-	-	-	-	-	-	-	-	-	x	x
Navrátil Aleš	26	100	34	3	-	2	5	9	-	1	3	23	6	2	18	340	430	384	12	-	-	1000	-	-	-	-	-	-	-	-	-	-	x	x
Novotný Radim	23	65	26	3	1	-	11	5	1	2	1	13	3	1	22	400	477	444	21	15	3	923	-	-	-	-	-	-	-	-	-	-	x	x
Ondra Tomáš	10	8	3	2	-	-	3	-	-	-	-	2	-	-	1	375	625	375	1	5	-	1000	8	1	4	1	2	38,0	25	13	13	800	3,08	
Ramirez Devon	18	64	14	2	-	1	7	9	3	1	1	7	6	1	13	219	297	338	34	9	2	956	3	1	1	-	-	9,1	12	2	2	1000	1,93	
Satoria Matěj	12	2	1	-	-	-	-	-	-	-	-	-	-	-	-	500	500	500	6	-	-	1000	11	-	1	-	1	19,1	8	19	19	1000	8,84	
Satoria Ondřej	10	-	-	-	-	-	-	-	-	-	-	-	-	-	-	x	x	x	6	15	1	955	10	1	7	-	-	55,0	53	19	15	1000	2,45	
Šmoldas Martin	12	20	3	-	-	-	4	5	-	1	-	3	-	-	4	150	150	320	8	5	3	813	-	-	-	-	-	-	-	-	-	-	x	x
Voják Jakub	5	13	5	1	-	1	-	3	2	1	2	8	-	-	3	385	692	500	16	3	-	1000	-	-	-	-	-	-	-	-	-	-	x	x
Vykoukal Marko	7	-	-	-	-	-	-	-	-	-	-	-	-	-	-	x	x	x	3	2	1	833	7	2	3	3	1	41,0	27	21	17	500	3,73	
Vykoukal Michael	25	84	32	6	-	4	10	17	1	1	5	26	3	2	29	381	595	467	158	10	4	977	-	-	-	-	-	-	-	-	-	-	x	x

Extraliga 2018 - základní část
Extra League 2018 - regular season



hráč <i>player</i>	pálka / <i>batting</i>											pole / <i>fielding</i>						nadhoz / <i>pitching</i>																
	G	AB	H	2B	3B	HR	SO	BB	HP	SH	SF	RBI	SB	CS	R	BA	SLG	OBP	PO	A	E	FA	G	CG	W	L	SV	IP	K	R-	ER	W/L	ERA	
Kotlářka Praha	27	901	258	56	5	23	157	114	22	7	11	175	45	7	208	286	436	376	679	243	49	950	27	2	19	8	3	226,0	215	112	81	704	3,23	
Aubrecht Ivan	21	73	20	5	-	1	22	6	1	1	-	12	5	1	15	274	384	338	74	3	3	963	-	-	-	-	-	-	-	-	-	-	x	x
Blažka Ondřej	27	101	25	4	2	1	24	14	4	2	-	10	16	1	33	248	356	361	34	2	2	947	-	-	-	-	-	-	-	-	-	-	x	x
Brebner Jackson	22	69	19	5	-	1	12	4	2	-	2	21	-	-	6	275	391	325	34	23	3	950	11	-	4	2	-	63,1	30	23	15	667	2,13	
Cihlář Josef	4	-	-	-	-	-	-	-	-	-	-	-	-	-	-	x	x	x	-	-	-	x	4	-	-	1	1	5,2	6	5	4	000	6,35	
Dupal Štěpán	8	4	1	-	-	-	1	1	-	-	-	-	-	-	-	250	250	400	1	2	-	1000	8	-	3	-	1	17,1	23	3	1	1000	0,52	
Ercoli Lukáš	14	1	-	-	-	-	-	1	-	-	-	-	-	-	-	000	000	500	2	2	-	1000	14	-	1	2	-	28,1	40	16	9	333	2,86	
Jasanský Alfréd	3	3	-	-	-	-	1	1	-	-	-	-	1	-	1	000	000	250	2	1	-	1000	-	-	-	-	-	-	-	-	-	x	x	
Král Michael	5	-	-	-	-	-	-	-	-	-	-	-	-	-	-	x	x	x	-	1	-	1000	5	1	1	-	-	10,1	10	8	8	1000	6,97	
Mulhearn Scott	27	102	37	5	-	7	9	15	2	-	2	30	1	1	30	363	618	446	40	64	8	929	1	-	-	-	-	1,1	-	2	-	x	0,00	
Müller Michal	7	25	6	-	-	-	3	1	1	1	-	3	1	-	3	240	240	296	8	17	2	926	-	-	-	-	-	-	-	-	-	x	x	
Mužik Martin	7	24	7	2	-	-	3	2	1	-	-	2	2	1	4	292	375	370	61	9	3	959	-	-	-	-	-	-	-	-	-	x	x	
Novák Jan	12	4	2	1	-	-	-	-	-	-	-	3	-	-	-	500	750	500	2	11	2	867	11	1	7	2	-	64,0	74	31	22	778	3,09	
Padyšák Daniel	11	26	3	-	-	-	6	6	-	1	-	1	2	-	5	115	115	281	5	12	2	895	3	-	1	-	1	11,0	17	5	5	1000	4,09	
Puš Jáchym	16	33	7	1	-	-	7	3	1	-	1	5	1	-	6	212	242	289	8	23	4	886	-	-	-	-	-	-	-	-	-	x	x	
Sládek Jakub	14	51	13	1	1	4	19	6	-	-	-	15	-	-	11	255	549	333	48	2	2	962	-	-	-	-	-	-	-	-	-	x	x	
Smola Filip	6	23	5	-	-	1	1	2	-	-	-	6	1	-	4	217	348	280	9	14	2	920	-	-	-	-	-	-	-	-	-	x	x	
Šůcha Matěj	24	83	19	5	1	2	23	4	2	1	-	13	3	1	13	229	386	281	51	2	2	964	-	-	-	-	-	-	-	-	-	x	x	
Truesdale Joseph	19	67	20	7	-	1	6	7	4	-	-	7	1	-	15	299	448	397	27	1	-	1000	-	-	-	-	-	-	-	-	-	x	x	
Tsurumaki Rio	15	48	16	4	1	1	2	8	2	1	-	4	7	1	12	333	521	448	20	13	4	892	-	-	-	-	-	-	-	-	-	x	x	
Vančura Jakub	9	19	2	1	-	-	3	2	-	-	-	5	-	-	2	105	158	190	35	1	1	973	-	-	-	-	-	-	-	-	-	x	x	
Vavruša Daniel	26	93	43	15	-	4	7	22	1	-	4	28	1	-	37	462	753	550	209	15	4	982	-	-	-	-	-	-	-	-	-	x	x	
Vavruša Jiří	22	52	13	-	-	-	8	9	1	-	2	10	3	1	11	250	250	359	9	25	5	872	8	-	2	1	-	24,2	15	19	17	667	6,20	



Extraliga 2018 - základní část Extra League 2018 - regular season

hráč player	pálka / batting																pole / fielding						nadhaz / pitching										
	G	AB	H	2B	3B	HR	SO	BB	HP	SH	SF	RBI	SB	CS	R	BA	SLG	OBP	PO	A	E	FA	G	CG	W	L	SV	IP	K	R-	ER	W/L	ERA
Eagles Praha	27	943	297	54	12	26	151	110	37	10	16	185	56	12	222	315	480	401	681	287	40	960	27	1	19	8	2	221,2	195	112	82	704	3,33
Aschermann Martin	8	22	6	-	-	-	5	2	-	-	-	3	3	-	3	000	273	333	26	-	1	963	-	-	-	-	-	-	-	-	-	x	x
Blažek Šimon	14	26	6	-	1	-	12	1	1	-	-	2	-	-	3	006	308	286	9	11	3	870	1	-	-	1	-	1,0	1	4	4	000	36,00
Bužga Vojtěch	18	41	6	-	-	-	7	10	1	1	-	3	3	-	9	011	146	327	15	40	2	965	2	-	-	-	-	2,1	5	-	-	x	0,00
Dijck Rick	10	-	-	-	-	-	-	-	-	-	-	-	-	-	-	000	x	x	-	2	-	1000	10	-	2	1	-	30,0	29	19	14	667	4,20
Duffek Tomáš	11	-	-	-	-	-	-	-	-	-	-	-	-	-	-	000	x	x	3	17	1	952	11	-	6	2	1	59,2	51	35	22	750	3,32
Hegr Ondřej	4	-	-	-	-	-	-	-	-	-	-	-	-	-	-	012	x	x	2	1	-	1000	4	-	2	-	1	9,0	5	-	-	1000	0,00
Hejma Matěj	24	99	39	3	2	12	22	10	4	-	2	37	6	1	31	000	828	461	45	2	1	979	-	-	-	-	-	-	-	-	-	x	x
Homolka Jan	25	97	32	7	-	-	14	7	2	-	3	22	-	-	15	007	402	376	223	13	5	979	-	-	-	-	-	-	-	-	-	x	x
Chlup Marek	22	87	30	10	3	5	21	9	2	-	2	20	7	1	23	036	701	410	39	1	-	1000	-	-	-	-	-	-	-	-	-	x	x
Imramovský Jan	2	1	-	-	-	-	1	-	-	-	-	-	-	-	-	014	000	000	-	-	-	x	-	-	-	-	-	-	-	-	-	x	x
Josefus Lukáš	7	-	-	-	-	-	-	-	-	-	-	-	-	-	-	000	x	x	1	1	-	1000	7	-	-	-	-	10,2	6	4	2	x	1,69
Kachurka Aliaksei	5	13	4	-	-	-	2	2	-	1	1	2	-	-	2	000	308	375	16	1	-	1000	-	-	-	-	-	-	-	-	-	x	x
Kvapil Ondřej	7	-	-	-	-	-	-	-	-	-	-	-	-	-	-	000	x	x	-	2	-	1000	7	-	-	1	-	1,0	3	9	5	000	4,22
Laube Martin	8	27	8	1	-	-	7	5	1	1	-	3	1	-	6	008	333	424	9	-	-	1000	-	-	-	-	-	-	-	-	-	x	x
Machačka Zdeněk	1	2	-	-	-	-	1	2	-	-	-	1	-	-	1	001	000	500	6	1	-	1000	-	-	-	-	-	-	-	-	-	x	x
Mencl Matěj	2	-	-	-	-	-	-	-	-	-	-	-	-	-	-	007	x	x	-	-	-	x	2	-	1	-	-	2,0	2	3	3	1000	13,50
Mencl Pavel	2	5	-	-	-	-	1	1	-	-	-	-	-	-	2	008	000	167	-	-	-	x	1	-	-	-	-	1,0	2	-	-	x	0,00
Novotný Tomáš	2	2	-	-	-	-	1	-	-	-	-	-	-	-	-	000	000	000	-	-	-	x	-	-	-	-	-	-	-	-	-	x	x
Pojer Jan	23	80	25	4	-	-	5	12	4	1	2	10	2	1	18	023	363	418	19	2	1	955	-	-	-	-	-	-	-	-	-	x	x
Sandoval David	25	74	21	1	-	-	9	16	2	3	-	9	4	2	14	000	297	424	150	22	6	966	1	-	-	-	-	3,0	2	2	-	x	0,00
Šmidt Viktor	5	-	-	-	-	-	-	-	-	-	-	-	-	-	-	029	x	x	1	2	-	1000	5	-	-	-	-	11,2	7	6	4	x	3,09
Šulc Radek	18	60	13	2	-	-	11	9	3	2	-	5	5	2	9	000	250	347	4	12	1	941	-	-	-	-	-	-	-	-	-	x	x
Thurber Taylor	10	4	-	-	-	-	-	-	-	-	-	-	-	-	1	000	000	000	4	9	1	929	9	1	4	2	-	52,0	60	15	13	667	2,25
Uhnavý Jakub	1	1	1	-	-	-	-	-	-	-	-	-	-	-	1	002	1000	1000	-	-	-	x	-	-	-	-	-	-	-	-	-	x	x
Výbora Jan	1	-	-	-	-	-	-	-	-	-	-	-	-	-	-	031	x	x	-	-	-	x	1	-	-	-	-	1,1	1	2	2	x	13,50

Extraliga 2018 - základní část
Extra League 2018 - regular season



hráč player	pálka / batting																pole / fielding						nadhoz / pitching											
	G	AB	H	2B	3B	HR	SO	BB	HP	SH	SF	RBI	SB	CS	R	BA	SLG	OBP	PO	A	E	FA	G	CG	W	L	SV	IP	K	R-	ER	W/L	ERA	
Hroši Brno	27	911	256	38	13	8	187	103	28	15	9	143	63	9	174	281	378	368	691	280	32	968	27	2	17	10	5	230,2	227	104	81	630	3,16	
Bareš Martin	7	-	-	-	-	-	-	-	-	-	-	-	-	-	-	x	x	x	2	3	-	1000	7	-	3	2	-	31,0	20	17	16	600	4,65	
Barto Jeffrey	11	-	-	-	-	-	-	1	-	-	-	1	-	-	1	x	x	1000	-	3	-	1000	11	-	5	-	1	32,2	29	2	2	1000	0,55	
Boda Michal	1	1	1	-	-	-	-	-	-	-	-	2	-	-	1	1000	1000	1000	-	-	-	x	-	-	-	-	-	-	-	-	-	-	x	x
Claus Filip	26	90	25	4	-	2	27	7	7	1	3	15	2	-	18	278	389	364	13	44	4	934	-	-	-	-	-	-	-	-	-	-	x	x
Derhak Alexander	15	41	8	2	-	1	8	3	2	-	2	9	-	-	9	195	317	271	-	2	-	1000	5	-	-	-	-	10,1	12	3	2	x	1,74	
Dvořák Martin	18	57	14	3	3	1	7	-	-	1	-	13	1	-	9	246	456	246	119	12	4	970	-	-	-	-	-	-	-	-	-	x	x	
Kocour Dan	1	-	-	-	-	-	-	-	-	-	-	-	-	1	-	x	x	x	-	-	-	x	-	-	-	-	-	-	1	-	-	x	x	
Kollár Martin	23	79	27	6	-	-	13	14	2	1	-	8	3	1	24	342	418	453	49	6	4	932	2	-	-	-	-	2,0	3	-	-	x	0,00	
Kremláček Michael	25	78	21	5	-	-	14	12	1	5	-	17	3	2	16	269	333	374	182	13	2	990	-	-	-	-	-	-	-	-	-	x	x	
Kucin Jan	20	56	14	2	-	-	14	3	1	-	-	5	1	-	6	250	286	300	22	2	-	1000	5	-	-	-	2	15,1	7	4	3	x	1,76	
Mánek Jakub	5	12	2	-	1	-	3	-	-	-	-	1	-	-	1	167	333	167	4	-	-	1000	-	-	-	-	-	-	-	-	-	x	x	
Mc Dowall Kenneth	16	11	1	-	-	-	2	-	-	-	-	1	-	-	1	091	091	091	3	16	1	950	11	1	3	3	2	57,0	59	25	15	500	2,37	
Menšík Matěj	27	103	26	3	3	2	18	11	4	3	1	23	4	-	21	252	398	345	30	-	1	968	-	-	-	-	-	-	-	-	-	x	x	
Menšík Vojtěch	27	105	33	4	1	2	26	15	7	-	1	13	21	4	20	314	429	430	38	83	5	960	-	-	-	-	-	-	-	-	-	x	x	
Ondráček Jakub	27	93	20	2	1	-	16	13	-	1	2	12	7	-	9	215	258	306	50	66	3	975	-	-	-	-	-	-	-	-	-	x	x	
Ondráček Michal	23	93	39	4	2	-	16	10	1	1	-	7	17	-	23	419	505	481	43	1	-	1000	-	-	-	-	-	-	-	-	-	x	x	
Ondroušek Dan	6	11	2	-	-	-	3	1	-	1	-	-	1	-	-	182	182	250	4	1	-	1000	-	-	-	-	-	-	-	-	-	x	x	
Sitár Jaroslav	2	2	-	-	-	-	1	2	1	-	-	-	-	-	3	000	000	600	9	1	2	833	-	-	-	-	-	-	-	-	-	x	x	
Swagerty Stephen	12	-	-	-	-	-	-	-	-	-	-	-	-	-	-	x	x	x	3	11	2	875	12	1	4	5	-	62,2	84	40	31	444	4,45	
Tatar Martin	3	-	-	-	-	-	-	-	-	-	-	-	-	-	-	x	x	x	1	1	-	1000	3	-	2	-	-	13,2	8	6	5	1000	3,29	
Trunkát Lukáš	22	70	22	3	1	-	14	10	2	1	-	15	3	1	11	314	386	415	110	13	4	969	-	-	-	-	-	-	-	-	-	x	x	
Vašourek František	4	9	1	-	1	-	5	1	-	-	-	1	-	-	1	111	333	200	8	2	-	1000	-	-	-	-	-	-	-	-	-	x	x	
Wechsler Adam	3	-	-	-	-	-	-	-	-	-	-	-	-	-	-	x	x	x	1	-	-	1000	3	-	-	-	-	3,1	3	2	2	x	5,40	
Žondra Tomáš	4	-	-	-	-	-	-	-	-	-	-	-	-	-	-	x	x	x	-	-	-	x	4	-	-	-	-	2,2	1	5	5	x	16,88	

Extraliga 2018 - základní část
Extra League 2018 - regular season



hráč <i>player</i>	pálka / <i>batting</i>														pole / <i>fielding</i>						nadhoz / <i>pitching</i>												
	G	AB	H	2B	3B	HR	SO	BB	HP	SH	SF	RBI	SB	CS	R	BA	SLG	OBP	PO	A	E	FA	G	CG	W	L	SV	IP	K	R-	ER	W/L	ERA
Tempo Titans Praha	27	887	197	38	5	4	210	86	17	14	7	85	37	14	109	222	290	301	701	278	60	942	27	6	9	18	2	228,0	209	118	81	333	3,20
Bečka Vojtěch	14	22	6	-	-	-	10	3	1	-	-	1	1	-	4	273	273	385	20	16	1	973	1	-	-	-	-	1,0	-	2	1	x	9,00
Bužga Matěj	22	67	11	1	1	-	16	6	-	1	-	8	4	-	8	164	209	233	39	1	-	1000	-	-	-	-	-	-	-	-	-	x	x
Čuhel Lubomír	2	-	-	-	-	-	-	-	-	-	-	-	-	-	-	x	x	x	-	-	-	x	2	-	-	-	-	5,0	1	6	5	x	9,00
Lukačka Martin	13	6	-	-	-	-	1	4	1	-	-	1	-	-	1	000	000	455	5	4	2	818	10	-	-	6	1	33,0	23	18	16	000	4,36
Martinez Christopher	11	33	8	1	-	-	5	5	-	2	-	4	4	-	8	242	273	342	6	14	4	833	-	-	-	-	-	-	-	-	-	x	x
Mikš Marián	2	1	-	-	-	-	-	-	-	-	-	-	-	-	-	000	000	000	-	-	-	x	-	-	-	-	-	-	-	-	-	x	x
Minařík Marek	11	2	1	1	-	-	1	-	-	-	-	2	-	-	1	500	1000	500	5	17	7	759	9	1	2	4	1	61,1	55	30	15	333	2,20
Nepomucký Aleš	21	48	7	-	-	-	18	12	-	1	-	4	-	2	4	146	146	317	25	1	1	963	-	-	-	-	-	-	-	-	-	x	x
Nevěřil David	26	85	24	4	1	-	17	8	-	4	-	7	3	1	10	282	353	344	46	57	5	954	9	1	1	4	-	35,0	26	29	23	200	5,91
Peřina Šimon	24	83	22	8	1	-	16	8	3	1	-	8	4	3	11	265	386	351	25	1	1	963	3	-	-	1	-	4,0	2	2	1	000	2,25
Pláteník Matěj	22	60	15	3	-	-	21	9	3	1	2	4	2	1	10	250	300	365	96	4	5	952	-	-	-	-	-	-	-	-	-	x	x
Rabinowitz Jake	21	60	16	5	1	1	7	8	-	1	1	8	4	-	9	267	433	348	11	29	5	889	12	4	6	2	-	77,0	94	24	16	750	1,87
Rejman Marek	20	57	13	-	-	-	12	6	-	-	-	3	-	-	2	228	228	302	38	1	-	1000	-	-	-	-	-	-	-	-	-	x	x
Riegger Daniel	26	91	23	6	1	1	25	1	1	2	1	14	-	2	10	253	374	266	21	20	4	911	-	-	-	-	-	-	-	-	-	x	x
Schiefert Patrik	7	9	2	-	-	-	3	-	-	-	-	-	-	1	-	222	222	222	6	-	-	1000	-	-	-	-	-	-	-	-	-	x	x
Sobotka Jakub	2	1	-	-	-	-	1	-	-	-	-	-	-	-	-	000	000	000	2	-	-	1000	-	-	-	-	-	-	-	-	-	x	x
Sobotka Jan	3	-	-	-	-	-	-	-	-	-	-	-	1	-	-	x	x	x	-	-	1	000	2	-	-	1	-	6,0	3	6	3	000	4,50
Šuran Martin	7	8	-	-	-	-	4	3	1	-	-	-	3	2	2	000	000	333	6	-	-	1000	-	-	-	-	-	-	-	-	-	x	x
Šusta Petr	17	45	8	3	-	-	11	2	1	1	1	5	-	-	2	178	244	224	77	13	1	989	-	-	-	-	-	-	-	-	-	x	x
Vohánka David	26	106	20	3	-	2	13	7	4	-	2	9	8	2	14	189	274	261	60	72	15	898	4	-	-	-	-	5,2	5	1	1	x	1,59
Zajíček Adam	1	1	-	-	-	-	1	-	-	-	-	-	-	-	-	000	000	000	-	-	-	x	-	-	-	-	-	-	-	-	-	x	x
Zelenka Martin	26	102	21	3	-	-	28	4	2	-	-	7	3	-	13	206	235	250	213	28	8	968	-	-	-	-	-	-	-	-	-	x	x

Extraliga 2018 - základní část
Extra League 2018 - regular season



hráč player	pálka / batting														pole / fielding						nadhoz / pitching													
	G	AB	H	2B	3B	HR	SO	BB	HP	SH	SF	RBI	SB	CS	R	BA	SLG	OBP	PO	A	E	FA	G	CG	W	L	SV	IP	SO	R-	ER	W/L	ERA	
Třebíč Nuclears	27	838	181	20	6	4	254	98	18	15	11	102	38	9	118	216	268	308	647	271	71	928	27	1	9	18	3	221,0	169	190	148	333	6,03	
Brandon Valentin	7	-	-	-	-	-	-	-	-	-	-	-	-	-	-	x	x	x	2	5	3	700	6	-	-	2	-	18,2	13	14	13	000	6,27	
Cameron Daniel	16	55	22	6	1	1	2	8	3	2	-	11	1	-	13	400	600	500	54	17	5	934	1	-	-	-	-	1,0	-	-	-	x	0,00	
Davis Derron	26	96	28	-	1	-	12	19	-	1	1	9	8	3	17	292	313	405	35	67	11	903	1	-	-	-	-	0,2	1	7	7	x	94,50	
Doležal Dominik	27	92	23	3	-	2	27	3	3	-	1	13	3	-	12	250	348	293	35	2	3	925	4	-	-	1	1	2,1	1	9	8	000	30,86	
Dvořák Roman	2	1	-	-	-	-	1	-	-	-	-	-	-	-	-	000	000	000	-	1	-	1000	1	-	-	-	-	3,0	-	2	2	x	6,00	
Ešmír Michal	3	7	2	-	-	-	3	1	-	-	-	1	1	-	2	286	286	375	2	1	2	600	-	-	-	-	-	-	-	-	-	x	x	
Garcia Jesus	3	-	-	-	-	-	-	-	-	-	-	-	-	-	-	x	x	x	-	-	1	000	3	-	-	1	-	2,1	2	12	9	000	34,71	
Green Reece	10	1	-	-	-	-	1	1	-	-	-	-	-	-	-	000	000	500	2	6	2	800	8	1	3	1	1	43,2	49	16	9	750	1,85	
Hamža Ivan	15	44	13	4	1	-	7	5	1	2	-	7	-	-	8	295	432	380	93	4	5	951	-	-	-	-	-	-	-	-	-	x	x	
Hlouch Lukáš	18	20	3	1	-	-	6	6	-	1	-	4	5	-	-	150	200	346	32	23	1	982	11	-	4	6	1	60,2	44	36	21	400	3,12	
Krejčířik Marek	14	41	6	1	-	-	19	9	2	2	-	2	6	1	8	146	171	327	21	25	8	852	-	-	-	-	-	-	-	3	3	x	x	
Křivánek Michal	3	8	-	-	-	-	8	1	-	-	-	-	-	-	-	000	000	111	4	6	1	909	-	-	-	-	-	-	-	-	-	-	x	x
Křivánek Miroslav	21	73	12	2	-	-	24	1	-	2	1	6	-	2	9	164	192	173	30	48	6	929	-	-	-	-	-	-	-	-	-	-	x	x
Kutílek Zdeněk	21	66	16	-	1	-	31	8	6	1	2	13	7	3	10	242	273	366	40	1	2	953	-	-	-	-	-	-	-	-	-	-	x	x
Libiak Jozef	1	2	-	-	-	-	2	-	-	-	-	-	-	-	-	000	000	000	-	-	-	x	-	-	-	-	-	-	-	-	-	-	x	x
Novotný Jiří	23	71	15	-	-	-	19	7	1	2	2	9	3	-	10	211	211	284	16	1	2	895	-	-	-	-	-	-	-	-	-	-	x	x
Pejchal Kamil	21	72	15	-	-	-	39	11	-	1	1	7	1	-	8	208	208	310	96	18	6	950	-	-	-	-	-	-	-	-	-	-	x	x
Pruša Michal	12	-	-	-	-	-	-	-	-	-	-	-	-	-	-	x	x	x	1	6	2	778	12	-	1	2	-	46,1	24	47	38	333	7,38	
Sklenář David	26	84	14	-	2	-	22	7	-	-	-	10	3	-	10	167	214	231	48	5	1	981	-	-	-	-	-	-	-	-	-	-	x	x
Tauš Václav	6	2	-	-	-	-	2	1	1	-	1	1	-	-	1	000	000	400	4	6	-	1000	6	-	-	1	-	19,1	13	15	14	000	6,52	
Touron Luis	8	27	4	2	-	1	5	2	1	-	-	1	-	-	3	148	333	233	24	3	2	931	-	-	-	-	-	-	-	-	-	-	x	x
Urbánek Jan	13	39	3	1	-	-	12	3	-	-	1	2	-	-	4	077	103	140	96	6	5	953	-	-	-	-	-	-	-	-	-	-	x	x

Extraliga 2018 - základní část
Extra League 2018 - regular season



hráč <i>player</i>	pálka / <i>batting</i>														pole / <i>fielding</i>						nadhaz / <i>pitching</i>												
	G	AB	H	2B	3B	HR	SO	BB	HP	SH	SF	RBI	SB	CS	R	BA	SLG	OBP	PO	A	E	FA	G	CG	W	L	SV	IP	SO	R-	ER	W/L	ERA
Olympia Blansko	28	860	186	28	3	1	245	68	20	10	7	65	50	11	92	216	259	287	666	257	66	933	28	2	6	22	-	223,0	156	219	165	214	6,66
Blažek Aleš	21	42	6	1	-	-	18	5	-	1	-	3	2	-	3	143	167	234	56	4	4	938	8	-	-	-	-	18,2	7	14	14	x	6,75
Farkaš David	25	81	18	4	1	-	20	5	3	1	-	6	7	-	5	222	296	292	41	14	3	948	7	-	1	2	-	27,2	15	32	25	333	8,13
Havlíček Štěpán	20	45	13	2	-	-	7	1	1	-	-	6	2	1	3	289	333	319	10	7	1	944	10	-	2	2	-	36,2	23	32	17	500	4,17
Hrubý Jiří	22	59	7	2	-	-	16	7	-	-	1	1	2	-	8	119	153	209	12	26	5	884	-	-	-	-	-	-	-	-	-	x	x
Jelínek Tomáš	26	68	16	2	-	-	24	7	3	-	1	7	6	3	12	235	265	329	50	-	2	962	7	-	-	2	-	15,2	9	10	10	000	5,74
Jelínek Zdeněk	7	17	5	2	-	-	4	1	-	-	-	1	-	1	1	294	412	333	7	-	1	875	-	-	-	-	-	-	-	-	-	x	x
Kabeš Ladislav	22	45	10	-	1	1	19	7	-	-	1	4	2	1	5	222	333	321	17	5	2	917	-	-	-	-	-	-	-	-	-	x	x
Kohoutek Michal	23	62	12	1	-	-	22	2	1	2	-	5	3	1	1	194	210	231	35	37	7	911	1	-	-	-	-	1,0	2	-	-	x	0,00
Kostka Jakub	26	58	11	-	-	-	25	6	-	2	-	4	3	1	8	190	190	266	35	64	14	876	11	1	2	9	-	75,0	52	57	39	182	4,68
Kříž Jaroslav	10	17	1	-	-	-	4	2	-	-	-	1	-	-	1	059	059	158	20	3	1	958	-	-	-	-	-	-	-	-	-	x	x
Kučera Ivo	8	18	4	1	-	-	3	-	-	-	1	3	1	-	1	222	278	211	14	-	-	1000	-	-	-	-	-	-	-	-	-	x	x
Lošťák David	21	70	16	3	-	-	16	3	7	2	3	8	5	-	11	229	271	313	40	36	10	884	-	-	-	-	-	-	-	-	-	x	x
Němec Jaroslav	26	95	29	6	-	-	15	9	2	1	-	8	8	-	13	305	368	377	64	5	3	958	3	-	-	-	-	5,0	2	1	-	x	0,00
Šebela Ondřej	7	10	-	-	-	-	5	1	-	-	-	-	1	-	1	000	000	091	3	3	1	857	1	-	-	-	-	-	-	-	1	x	x
Šustal Jiří	18	56	11	2	-	-	14	2	1	1	-	3	2	1	5	196	232	237	107	2	6	948	-	-	-	-	-	-	-	-	-	x	x
Ue Natsuhiko	27	104	26	2	1	-	27	10	2	-	-	5	6	2	13	250	288	328	148	45	4	980	1	-	-	-	-	1,0	1	1	1	x	9,00
Yasuda Akimasa	17	13	1	-	-	-	6	-	-	-	-	-	-	-	1	077	077	077	7	6	2	867	12	1	1	7	-	42,1	45	72	58	125	12,33

Extraliga 2018 - základní část
Extra League 2018 - regular season



hráč player	pálka / batting																pole / fielding						nadhoz / pitching										
	G	AB	H	2B	3B	HR	SO	BB	HP	SH	SF	RBI	SB	CS	R	BA	SLG	OBP	PO	A	E	FA	G	CG	W	L	SV	IP	K	R-	ER	W/L	ERA
Skokani Olomouc	27	794	164	28	4	4	196	97	26	9	3	68	25	9	91	207	267	312	602	266	64	931	27	6	5	22	1	208,1	97	255	187	185	8,08
Adamus Jindřich	4	11	3	1	-	-	5	2	1	1	-	3	-	-	3	273	364	429	5	1	-	1000	-	-	-	-	-	-	-	-	-	x	x
Antoš Ondřej	13	36	9	1	1	-	13	5	2	-	-	5	2	-	6	250	333	372	21	2	3	885	-	-	-	-	-	-	-	-	-	x	x
Borůvka Jakub	21	48	7	2	-	-	9	2	-	1	-	4	2	-	5	146	188	180	27	13	5	889	-	-	-	-	-	-	-	-	-	x	x
Daněk Filip	4	6	-	-	-	-	4	1	-	-	-	-	-	-	-	000	000	143	5	-	-	1000	-	-	-	-	-	-	-	-	-	x	x
Fusek Aleš	4	4	-	-	-	-	3	2	-	-	-	-	-	-	-	000	000	333	2	2	-	1000	-	-	-	-	-	-	-	-	-	x	x
Chapman Joel	20	38	10	2	-	-	7	2	1	-	-	1	1	1	1	263	316	317	36	12	-	1000	10	5	3	6	-	77,0	39	54	37	333	4,32
Kohout Michal	6	-	-	-	-	-	-	-	-	-	-	-	-	-	-	x	x	x	1	6	-	1000	6	-	1	3	-	28,1	14	27	25	250	7,94
Košata Ondřej	3	3	-	-	-	-	2	-	-	-	-	-	-	-	-	000	000	000	3	-	-	1000	1	-	-	-	-	0,2	1	7	7	x	94,50
Kovařík Jiří	21	65	13	5	-	-	14	14	1	-	1	6	-	1	5	200	277	346	40	15	1	982	-	-	-	-	-	-	-	-	-	x	x
Lázníček Matěj	27	97	30	4	-	3	21	6	2	-	-	16	7	1	9	309	443	362	58	1	5	922	1	-	-	1	-	2,0	2	5	5	000	22,50
Mik Petr	13	8	-	-	-	-	2	1	-	-	-	-	1	-	-	000	000	111	4	5	3	750	11	-	-	1	1	21,1	8	35	22	000	9,28
Poledna Martin	22	51	3	1	-	-	21	4	2	3	-	-	-	-	-	059	078	158	43	2	2	957	-	-	-	-	-	-	-	-	-	x	x
Schwarz Ondřej	24	73	11	-	-	-	14	7	1	1	-	7	-	2	6	151	151	235	46	31	8	906	2	-	-	-	-	6,0	1	6	4	x	6,00
Schwarz Pavel	9	4	-	-	-	-	3	-	-	-	-	-	-	-	-	000	000	000	1	-	-	1000	7	-	-	1	-	7,2	5	17	16	000	18,78
Sova Marek	21	66	20	4	-	-	13	4	5	-	-	3	-	-	8	303	364	387	52	4	5	918	-	-	-	-	-	-	-	-	-	x	x
Šimek Jiří	4	2	1	-	-	-	-	-	-	-	-	-	-	-	-	500	500	500	-	2	-	1000	4	-	-	2	-	14,0	4	16	13	000	8,36
Utěšený Jan	15	42	7	1	1	-	10	7	3	-	-	4	4	-	8	167	238	327	120	8	1	992	-	-	-	-	-	-	-	-	-	x	x
Van der Linden Nathan	25	92	22	2	-	-	16	8	3	-	2	8	4	1	15	239	261	314	43	90	10	930	5	-	-	3	-	14,2	12	34	16	000	9,82
Veselý Lukáš	5	-	-	-	-	-	-	-	-	-	-	-	-	-	-	x	x	x	1	3	1	800	5	-	1	4	-	23,0	9	32	30	200	11,74
Voják Jakub	19	54	16	4	2	1	9	17	5	1	-	3	4	1	14	296	500	500	68	15	1	988	-	-	-	-	-	-	-	-	-	x	x
Vrba Vojtěch	4	7	-	-	-	-	5	2	-	-	-	-	-	-	-	000	000	222	1	-	-	1000	-	-	-	-	-	-	-	-	-	x	x
Zdražil Martin	27	79	10	1	-	-	23	13	-	2	-	8	-	2	10	127	139	250	23	49	15	828	4	1	-	1	-	13,2	2	22	12	000	7,90
Zhupanin Vasil	3	8	2	-	-	-	2	-	-	-	-	-	-	-	1	250	250	250	2	5	4	636	1	-	-	-	-	-	-	-	-	x	x

Extraliga 2018 - základní část
Extra League 2018 - regular season



hráč player	pálka / batting															pole / fielding						nadhoz / pitching											
	G	AB	H	2B	3B	HR	SO	BB	HP	SH	SF	RBI	SB	CS	R	BA	SLG	OBP	PO	A	E	FA	G	CG	W	L	SV	IP	K	R-	ER	W/L	ERA
Technika Brno	27	860	179	20	1	6	217	79	11	4	3	67	17	9	77	208	255	282	651	246	62	935	27	6	3	24	-	218,0	211	219	140	111	5,78
Bláha Vojtěch	4	6	2	-	-	-	4	-	-	-	-	-	-	-	-	333	333	333	2	3	-	1000	3	-	-	-	-	5,0	1	9	9	x	16,20
Brabec Matěj	16	53	6	-	-	-	20	4	-	1	-	-	-	-	5	113	113	175	9	19	9	757	-	-	-	-	-	-	-	-	-	x	x
Burian Radek	7	2	-	-	-	-	1	-	-	-	-	-	-	-	-	000	000	000	-	1	-	1000	7	-	-	2	-	6,0	4	15	15	000	22,50
Gallardo August	12	16	4	-	-	-	2	4	1	-	-	2	-	-	2	250	250	429	4	6	1	909	9	1	-	7	-	51,0	62	40	30	000	5,29
Georgiev Georgi	2	7	2	-	-	-	1	-	-	-	-	-	-	-	-	286	286	286	10	2	-	1000	-	-	-	-	-	-	-	-	-	x	x
Goleš Petr	8	13	2	1	-	-	5	1	1	1	-	2	1	-	-	154	231	267	16	6	2	917	-	-	-	-	-	-	-	-	-	x	x
Gottschall Mário	27	95	26	1	-	3	23	6	2	-	1	16	2	-	8	274	379	327	170	26	7	966	-	-	-	-	-	-	-	-	-	x	x
Janík Karel	1	-	-	-	-	-	-	-	-	-	-	-	-	-	-	x	x	x	-	-	-	x	1	-	-	-	-	0,2	-	3	3	x	40,50
Johnson Julian	7	27	8	1	-	1	8	3	-	-	-	3	1	-	3	296	444	367	12	-	1	923	-	-	-	-	-	-	-	-	-	x	x
Just Daniel	4	2	-	-	-	-	2	1	-	-	-	-	-	-	-	000	000	333	-	3	1	750	3	-	-	-	-	5,2	7	8	7	x	11,12
Kelar Sebastian	19	66	7	-	-	-	25	7	-	-	-	2	2	2	7	106	106	192	28	54	7	921	-	-	-	-	-	-	-	-	-	x	x
Klimes Michal	25	83	13	2	-	-	20	5	2	-	-	4	2	2	5	157	181	222	39	29	9	883	3	-	-	1	-	7,1	4	14	9	000	11,05
Kočí Michal	23	58	14	1	-	-	10	6	-	-	-	4	-	1	7	241	259	313	114	11	1	992	9	-	1	5	-	38,1	21	45	26	167	6,10
Lincoln Dominique	19	69	17	2	-	-	7	6	3	-	-	3	3	2	13	246	275	333	26	1	-	1000	2	-	-	1	-	2,1	3	9	4	000	15,43
Matějka Filip	5	6	-	-	-	-	3	1	-	-	-	-	-	1	1	000	000	143	2	-	-	1000	-	-	-	-	-	-	-	-	-	x	x
Nováček Milan	6	1	-	-	-	-	-	1	-	-	-	-	-	-	-	000	000	500	-	1	-	1000	6	-	-	-	-	12,1	7	21	10	x	7,30
Pomazal Vojtěch	13	39	12	2	-	1	10	6	-	-	-	7	1	-	3	308	436	400	7	26	7	825	-	-	-	-	-	-	-	-	-	x	x
Regner Martin	2	2	-	-	-	-	1	-	-	-	-	-	-	-	-	000	000	000	5	-	1	833	1	-	-	-	-	1,0	1	-	-	x	0,00
Regner Robert	20	58	6	1	-	-	18	7	-	1	-	2	1	1	5	103	121	200	22	24	3	939	-	-	-	-	-	-	-	-	-	x	x
Rivera Joe	12	6	-	-	-	-	-	1	-	-	-	-	-	-	2	000	000	143	2	18	-	1000	12	5	2	8	-	79,2	96	34	16	200	1,81
Sázavský Oliver	11	30	9	-	-	-	8	-	-	-	1	2	1	-	3	300	300	290	19	-	3	864	-	-	-	-	-	-	-	-	-	x	x
Sázavský Richard	24	88	26	4	1	1	7	5	-	1	1	12	3	-	7	295	398	330	52	3	4	932	-	-	-	-	-	-	-	-	-	x	x
Štřítecký Martin	15	42	9	1	-	-	8	8	-	-	-	4	-	-	4	214	238	340	33	6	1	975	4	-	-	-	6,2	4	9	5	x	6,75	
Svoboda Jakub	3	5	-	-	-	-	3	-	-	-	-	-	-	-	-	000	000	000	1	1	1	667	-	-	-	-	-	-	-	-	-	x	x
Škaroupka Martin	2	4	2	-	-	-	-	-	-	-	-	-	-	-	-	500	500	500	-	-	1	000	-	-	-	-	-	-	-	-	-	x	x
Štingl Jan	5	8	-	-	-	-	3	-	-	-	-	-	-	-	-	000	000	000	1	-	1	500	-	-	-	-	-	-	-	-	-	x	x
Švábenský Vojta	2	1	-	-	-	-	1	-	-	-	-	-	-	-	-	000	000	000	-	-	-	x	-	-	-	-	-	-	-	-	-	x	x
Tellez Yasser	11	18	5	-	-	-	4	4	-	-	-	1	-	-	2	278	278	409	3	4	1	875	3	-	-	-	2,0	1	12	6	x	27,00	
Vašek Jakub	21	55	9	4	-	-	23	3	2	-	-	3	-	-	-	164	236	233	74	2	1	987	-	-	-	-	-	-	-	-	-	x	x

Extraliga 2018 - nadstavba
Extra League 2018 - post season

1.	Draci Brno	
2.	Arrows Ostrava	
3.	Eagles Praha	
4.	Kotlářka Praha	
5.	Tempo Titans Praha	
6.	Hroši Brno	

Extraliga 2018 - nadstavba
Extra League 2018 - post season

	Draci	Arrows	Eagles	Kotlářka	Tempo	Hroši	G	W	L	PCT	R	R-
Draci Brno		4 - 2	10 - 2	9 - 5	10 - 5	7 - 3	20	16	4	800	155	72
		5 - 3	11 - 1	0 - 5	11 - 6	12 - 5						
		8 - 1	8 - 3	12 - 2	5 - 2	16 - 1						
		7 - 8	3 - 5	8 - 10	4 - 2	5 - 1						
Arrows Ostrava	2 - 4		10 - 0	5 - 4	17 - 2	13 - 3	20	14	6	700	157	92
	3 - 5		10 - 9	10 - 9	16 - 1	3 - 2						
	1 - 8		5 - 4	18 - 6	10 - 4	13 - 8						
	8 - 7		1 - 2	5 - 10	2 - 4	5 - 0						
Eagles Praha	2 - 10	0 - 10		4 - 3	16 - 6	5 - 0	20	11	9	550	109	128
	1 - 11	9 - 10		4 - 3	8 - 0	10 - 6						
	3 - 8	4 - 5		9 - 13	5 - 3	8 - 5						
	5 - 3	2 - 1		7 - 15	3 - 2	4 - 14						
Kotlářka Praha	5 - 9	4 - 5	3 - 4		7 - 3	5 - 8	20	10	10	500	152	127
	5 - 0	9 - 10	3 - 4		12 - 1	4 - 5						
	2 - 12	6 - 18	13 - 9		7 - 13	3 - 0						
	10 - 8	10 - 5	15 - 7		17 - 1	12 - 5						
Tempo Titans	5 - 10	2 - 17	6 - 16	3 - 7		3 - 4	20	5	15	250	77	164
	6 - 11	1 - 16	0 - 8	1 - 12		6 - 3						
	2 - 5	4 - 10	3 - 5	13 - 7		8 - 3						
	2 - 4	4 - 2	2 - 3	1 - 17		5 - 4						
Hroši Brno	3 - 7	3 - 13	0 - 5	8 - 5	4 - 3		20	4	16	200	80	147
	5 - 12	2 - 3	6 - 10	5 - 4	3 - 6							
	1 - 16	8 - 13	5 - 8	0 - 3	3 - 8							
	1 - 5	0 - 5	14 - 4	5 - 12	4 - 5							

tučně jsou uvedena domácí utkání

home games are bold

Extraliga 2018 - nadstavba
Extra League 2018 - division Top6

H	BA (AB»29)	HR	TB
32 Chroust Přemek, Dra	500 Aubrecht Ivan, Kot	13 Joyce Terrell, Arr	72 Joyce Terrell, Arr
29 Dubový Arnošt, Dra	444 Čech Petr, Dra	9 Vavruša Daniel, Kot	63 Vavruša Daniel, Kot
29 Joyce Terrell, Arr	426 Joyce Terrell, Arr	6 Mužík Martin, Kot	47 Mužík Martin, Kot
29 Vavruša Daniel, Kot	416 Chroust Přemek, Dra	5 Hejma Matěj, Eag	45 Chroust Přemek, Dra
28 Čech Petr, Dra	393 Minařík Marek, Tem	4 Šůcha Matěj, Kot	44 Hejma Matěj, Eag
28 Kremláček Mich., Hro	379 Hejma Matěj, Eag	3 Čech Petr, Dra	43 Čech Petr, Dra
26 Mužík Martin, Kot	378 Kremláček Mich., Hro	3 Chroust Přemek, Dra	41 Dubový Arnošt, Dra
26 Vohánka David, Tem	373 Malík Jakub, Arr	3 Juněc Tomáš, Arr	39 Šůcha Matěj, Kot
25 Malík Jakub, Arr	367 Vavruša Daniel, Kot	3 Malík Jakub, Arr	38 Malík Jakub, Arr
24 2 hráči / players	351 Mužík Martin, Kot	2 8 hráčů / players	37 Kremláček Michael, Hro
SLG (AB»29)	BB	OBP (AB+BB+HP+SF»32)	RBI
1059 Joyce Terrell, Arr	16 Kubica Jakub, Arr	535 Aubrecht Ivan, Kot	37 Joyce Terrell, Arr
797 Vavruša Daniel, Kot	16 Nevěřil David, Tem	530 Joyce Terrell, Arr	25 Vavruša Daniel, Kot
759 Hejma Matěj, Eag	15 Joyce Terrell, Arr	526 Čech Petr, Dra	24 Chroust Přemek, Dra
683 Čech Petr, Dra	14 Malík Jakub, Arr	494 Malík Jakub, Arr	23 Hejma Matěj, Eag
635 Mužík Martin, Kot	14 Moštěk Filip, Dra	485 Kubica Jakub, Arr	23 Malík Jakub, Arr
584 Chroust Přemek, Dra	14 Zýma Petr, Eag	478 Wittig Joseph, Eag	22 Čech Petr, Dra
579 Aubrecht Ivan, Kot	13 Blažka Ondřej, Kot	477 Chroust Přemek, Dra	21 Šůcha Matěj, Kot
571 Minařík Marek, Tem	13 Mužík Martin, Kot	473 Mužík Martin, Kot	17 Mužík Martin, Kot
567 Malík Jakub, Arr	12 5 hráčů / players	467 Hejma Matěj, Eag	17 Vykoukal Michael, Arr
542 Šůcha Matěj, Kot		440 Schneider Martin, Dra	16 2 hráči / players
SB	R	CG	W
9 Ondráček Jakub, Hro	28 Mužík Martin, Kot	3 Novák Jan, Kot	5 Hussey John, Dra
6 Blažka Ondřej, Kot	27 Joyce Terrell, Arr	3 Rabinowitz Jake, Tem	5 Chroust Radim, Dra
6 Hubbard Dondrei, Dra	26 Dubový Arnošt, Dra	3 Thurber Taylor, Eag	5 Novák Jan, Kot
6 Sandoval David, Eag	23 Voják Jakub, Arr	3 Vykoukal Marko, Arr	5 Thurber Taylor, Eag
6 Wittig Joseph, Eag	22 Vavruša Daniel, Kot	2 Burkholder Christ., Arr	5 Vykoukal Marko, Arr
6 Zýma Petr, Eag	21 Hubbard Dondrei, Dra	2 Hussey John, Dra	4 Satoria Ondřej, Arr
5 Dubový Arnošt, Dra	21 Nevěřil David, Tem	1 5 hráčů / players	3 Minařík Petr, Dra
5 Ondráček Michal, Hro	20 Mulhearn Scott, Kot		3 Rabinowitz Jake, Tem
4 5 hráčů / players	19 Novotný Radim, Arr		2 7 hráčů / players
	18 Malík Jakub, Arr		
SAV	W/L (W+L»2)	IP	K
1 14 hráčů / players	5-0 Chroust Radim, Dra	57,2 Rabinowitz Jake, Tem	52 Novák Jan, Kot
	3-0 Minařík Petr, Dra	49,2 Thurber Taylor, Eag	49 Thurber Taylor, Eag
	2-0 Kvapil Ondřej, Eag	46,2 Novák Jan, Kot	47 Rabinowitz Jake, Tem
	2-0 Ondra Tomáš, Arr	43,2 Mc Dowall Ken., Hro	44 Chroust Radim, Dra
	5-1 Hussey John, Dra	41,2 Hussey John, Dra	43 Hussey John, Dra
	5-1 Vykoukal Marko, Arr	41,0 Duffek Tomáš, Eag	43 Mc Dowall Kenneth, Hro
	4-1 Satoria Ondřej, Arr	39,2 Burkholder Christ., Arr	41 Burkholder Chris, Arr
	5-2 Novák Jan, Kot	39,0 Chroust Radim, Dra	40 Vykoukal Marko, Arr
	2-1 4 hráči / players	38,1 Vykoukal Marko, Arr	31 Duffek Tomáš, Eag
		32,2 Barto Jeffrey, Hro	31 Satoria Ondřej, Arr
ERA (IP»11,2)	PO	A	FA (PO+A+E»30)
0,75 Vašourek Jan, Dra	164 Homolka Jan, Eag	54 Vohánka David, Tem	106-0 Čech Petr, Dra
1,85 Chroust Radim, Dra	152 Mužík Martin, Kot	52 Zýma Michal, Eag	63-0 Voják Jakub, Arr
1,88 Vykoukal Marko, Arr	126 Sandoval David, Eag	49 Hajtmar Jakub, Dra	47-0 Dubový Arnošt, Dra
2,38 Hussey John, Dra	115 Dvořák Martin, Hro	49 Ondráček Jakub, Hro	44-0 Malík Jakub, Arr
2,66 Minařík Petr, Dra	111 Juněc Tomáš, Arr	48 Zýma Petr, Eag	34-0 Novotný Radim, Arr
2,81 Rabinowitz Jake, Tem	106 Vykoukal Michael, Arr	37 Rabinowitz Jake, Tem	991 Vykoukal Michael, Arr
3,07 Duffek Tomáš, Eag	99 Čech Petr, Dra	36 Smola Filip, Kot	990 Rejman Marek, Tem
3,26 Ondra Tomáš, Arr	99 Zelenka Martin, Tem	35 Grepl Jakub, Arr	989 Homolka Jan, Eag
3,40 Burkholder Chris, Arr	98 Vavruša Daniel, Kot	33 3 hráči / players	989 Hubbard Dondrei, Dra
3,50 Padyšák Daniel, Kot	97 Rejman Marek, Tem		988 Mužík Martin, Kot

Extraliga 2018 - nadstavba
Extra League 2018 - division Top6

pálkař / hitter	H	AB	BA	nadhazovač/pitcher	ER	IP	ERA	poľař / fielder	PO	A	E	FA
1 Aubrecht Ivan, Kot	19	38	500	1 Vašourek Jan, Dra	1	12,0	0,75	1 Čech Petr, Dra	99	7	-	1000
2 Čech Petr, Dra	28	63	444	2 Chroust Radim, Dra	8	39,0	1,85	Voják Jakub, Arr	57	6	-	1000
3 Joyce Terrell, Arr	29	68	426	3 Vykoukal Marko, Arr	8	38,1	1,88	Dubový Arnošt, Dra	46	1	-	1000
4 Chroust Přemek, Dra	32	77	416	4 Hussey John, Dra	11	41,2	2,38	Malík Jakub, Arr	43	1	-	1000
5 Minařík Marek, Tem	22	56	393	5 Minařík Petr, Dra	7	23,2	2,66	Novotný Radim, Arr	29	5	-	1000
6 Hejma Matěj, Eag	22	58	379	6 Rabinowitz Jake, Tem	18	57,2	2,81	6 Vykoukal Michael, Arr	106	9	1	991
7 Kremláček Michael, Hro	28	74	378	7 Duffek Tomáš, Eag	14	41,0	3,07	7 Rejman Marek, Tem	97	7	1	990
8 Malík Jakub, Arr	25	67	373	8 Ondra Tomáš, Arr	7	19,1	3,26	8 Homolka Jan, Eag	164	10	2	989
9 Vavruša Daniel, Kot	29	79	367	9 Burkholder Christ., Arr	15	39,2	3,40	Hubbard Dondrei, Dra	66	21	1	989
10 Mužík Martin, Kot	26	74	351	10 Padyšák Daniel, Kot	7	18,0	3,50	10 Mužík Martin, Kot	152	17	2	988
11 Vohánka David, Tem	26	75	347	11 Barto Jeffrey, Hro	14	32,2	3,86	11 Chroust Přemek, Dra	93	12	2	981
12 Navrátil Aleš, Arr	14	41	341	12 Satoria Ondřej, Arr	12	27,2	3,90	12 Bužga Matěj, Tem	47	2	1	980
13 Dubový Arnošt, Dra	29	86	337	13 Novák Jan, Kot	21	46,2	4,05	13 Claus Filip, Hro	42	6	1	980
14 Kubica Jakub, Arr	16	50	320	14 Brebner Jackson, Kot	14	30,0	4,20	14 Nepomucký Aleš, Tem	44	3	1	979
15 Šucha Matěj, Kot	23	72	319	15 Mc Dowall Kenneth, Hro	21	43,2	4,33	15 Brebner Jackson, Kot	33	10	1	977
16 Rabinowitz Jake, Tem	20	64	313	16 Mulhearn Scott, Kot	12	23,0	4,70	16 Šucha Matěj, Kot	42	-	1	977
Tsurumaki Rio, Kot	20	64	313	17 Bokaj Boris, Arr	17	30,1	5,04	17 Kubica Jakub, Arr	15	26	1	976
Brebner Jackson, Kot	15	48	313	18 Thurber Taylor, Eag	28	49,2	5,07	18 Zelenka Martin, Tem	99	17	3	975
19 Ondráček Michal, Hro	19	61	311	19 Nevěřil David, Tem	17	28,1	5,40	19 Budský Pavel, Dra	76	1	2	975
20 Hubbard Dondrei, Dra	24	79	304	Furko Ondřej, Dra	14	23,1	5,40	20 Sandoval David, Eag	126	12	4	972
21 Smola Filip, Kot	10	33	303	21 Lukačka Martin, Tem	20	28,2	6,28	21 Dvořák Martin, Hro	115	11	4	969
22 Mulhearn Scott, Kot	24	80	300	22 Wittig Joseph, Eag	20	24,1	7,40	22 Chlup Marek, Eag	30	1	1	969
Grepl Jakub, Arr	18	60	300	23 Sobotka Michal, Dra	11	13,0	7,62	Šusta Petr, Tem	26	5	1	969
24 Menšík Matěj, Hro	19	64	297	24 Swagerty Stephen, Hro	27	30,1	8,01	24 Menšík Matěj, Hro	30	-	1	968
25 Moštěk Filip, Dra	18	61	295	25 Vavruša Jiří, Kot	20	20,2	8,71	Moštěk Filip, Dra	25	5	1	968
26 Červinka Martin, Dra	17	61	279	26 Kucin Jan, Hro	15	15,0	9,00	26 Juněc Tomáš, Arr	111	8	4	967
27 Chlup Marek, Eag	13	47	277	27 Satoria Matěj, Arr	13	11,2	10,03	27 Zýma Michal, Eag	57	52	4	965
28 Vykoukal Michael, Arr	21	76	276	28 Cihlář Josef, Kot	18	15,1	10,57	28 Smola Filip, Kot	17	36	2	964
29 Šulc Radek, Eag	14	51	275	29 Ercoli Lukáš, Kot	17	14,1	10,67	29 Joyce Terrell, Arr	48	1	2	961
30 Juněc Tomáš, Arr	17	62	274	30 Minařík Marek, Tem	23	18,0	11,50	30 Vavruša Daniel, Kot	98	22	5	960
31 Blažka Ondřej, Kot	21	77	273	31 Vohánka David, Tem	27	15,0	16,20	31 Ondráček Jakub, Hro	45	49	4	959
Zelenka Martin, Tem	18	66	273	Chlup Vladimír, Eag	0	2,0	0,00	32 Mulhearn Scott, Kot	37	32	3	958
Laube Martin, Eag	12	44	273	Sandoval David, Eag	0	1,0	0,00	33 Menšík Vojtěch, Hro	24	20	2	957
34 Wittig Joseph, Eag	13	48	271	Kvapil Ondřej, Eag	1	9,2	0,93	Sládek Jakub, Kot	44	-	2	957
35 Homolka Jan, Eag	20	74	270	Šmidt Viktor, Eag	2	10,1	1,74	35 Blažka Ondřej, Kot	40	1	2	953
36 Derhak Alexander, Hro	12	45	267	Schneider Martin, Dra	2	8,1	2,16	Ondráček Michal, Hro	41	-	2	953
37 Dvořák Martin, Hro	16	61	262	Bužga Vojtěch, Eag	3	8,2	3,12	37 Hejma Matěj, Eag	38	1	2	951
38 Zýma Petr, Eag	17	65	262	Kraut Svatoslav, Hro	4	11,1	3,18	Schneider Martin, Dra	16	22	2	950
39 Pojer Jan, Eag	19	73	260	Blažek Šimon, Eag	5	10,0	4,50	39 Pláteník Matěj, Tem	48	6	3	947
40 Cipolla Anthony, Arr	16	62	258	Kollár Martin, Hro	4	7,0	5,14	40 Červinka Martin, Dra	20	33	3	946
Padyšák Daniel, Kot	8	31	258	Nebenfuhr Jan, Dra	6	7,0	7,71	41 Rabinowitz Jake, Tem	13	37	3	943
42 Sandoval David, Eag	17	66	258	Josefus Lukáš, Eag	7	6,2	9,45	42 Kremláček Michael, Hro	70	5	5	938
43 Novotný Radim, Arr	13	51	255	Čapka Filip, Dra	4	3,0	12,00	43 Cipolla Anthony, Arr	22	33	4	932
44 Ondráček Jakub, Hro	17	69	246	Menšík Vojtěch, Hro	4	2,2	13,50	44 Hajtmar Jakub, Dra	26	49	6	926
45 Voják Jakub, Arr	16	65	246	Wechsler Adam, Hro	3	2,0	13,50	Martinez Christ., Tem	17	31	4	923
46 Nevěřil David, Tem	15	61	246	Čuhel Lubomír, Tem	14	8,2	14,54	46 Nevěřil David, Tem	26	33	5	922
47 Polanský Tomáš, Dra	10	43	233	Tatar Martin, Hro	9	5,1	15,19	47 Zýma Petr, Eag	16	48	6	914
48 Zýma Michal, Eag	18	78	231	Hegr Ondřej, Eag	11	6,0	16,50	48 Grepl Jakub, Arr	40	35	8	904
Budský Pavel, Dra	12	52	231	Bareš Martin, Hro	16	8,2	16,62	49 Vohánka David, Tem	24	54	9	897
50 Menšík Vojtěch, Hro	10	45	222	Sobotka Jan, Tem	15	5,2	23,82	50 Puš Jáchym, Kot	13	29	5	894
51 Jacques Adam, Hro	7	33	212	Derhak Alexander, Hro	11	3,2	27,00	51 Jacques Adam, Hro	5	22	5	844
52 Schneider Martin, Dra	7	34	206	Grundmann Martin, Eag	4	1,1	27,00	52 Minařík Marek, Tem	21	5	5	839
53 Hajtmar Jakub, Dra	14	70	200	Bečka Vojtěch, Tem	6	0,1	162,00	53 Wittig Joseph, Eag	10	28	8	826
Martinez Christ., Tem	10	50	200					Pojer Jan, Eag	27	2	-	1000

Extraliga 2018 - nadstavba
Extra League 2018 - division Top6

pálkař / hitter	H	AB	BA	nadhazovač/pitcher	ER	IP	ERA	poľař / fielder	PO	A	E	FA
55 Trunkát Lukáš, Hro	6	31	194					Vašourek František, Hro	25	2	-	1000
56 Rejman Marek, Tem	9	48	188					Derhak Alexander, Hro	4	18	-	1000
57 Bužga Matěj, Tem	9	50	180					Sitár Jaroslav, Hro	18	2	-	1000
58 Nepomucký Aleš, Tem	10	56	179					Kalábek Martin, Dra	16	1	-	1000
59 Claus Filip, Hro	7	43	163					Aubrecht Ivan, Kot	16	-	-	1000
60 Puš Jáchym, Kot	8	54	148					Blažek Šimon, Eag	4	11	-	1000
61 Kalábek Martin, Dra	4	34	118					Hussey John, Dra	2	11	-	1000
62 Pláteník Matěj, Tem	3	34	088					Řehůrek Lukáš, Dra	12	1	-	1000
Burkholder Christ., Arr	1	1	1000					Bokaj Boris, Arr	2	10	-	1000
Klanica Martin, Dra	1	1	1000					Burkholder Christ., Arr	3	9	-	1000
Čuhel Lubomír, Tem	1	2	500					Kollár Martin, Hro	10	2	-	1000
Ondroušek Dan, Hro	9	25	360					Šuran Martin, Tem	11	-	-	1000
Šmoldas Martin, Arr	6	19	316					Aschermann Martin, Eag	10	-	-	1000
Kaplan Jakub, Arr	3	11	273					Satoria Ondřej, Arr	3	6	-	1000
Řehůrek Lukáš, Dra	3	11	273					Furko Ondřej, Dra	1	7	-	1000
Lukačka Martin, Tem	5	19	263					Kocour Dan, Hro	8	-	-	1000
Šusta Petr, Tem	6	24	250					Mc Dowall Kenneth, Hro	2	6	-	1000
Bečka Vojtěch, Tem	1	4	250					Bečka Vojtěch, Tem	2	4	-	1000
Müller Michal, Kot	1	4	250					Černý Daniel, Arr	5	-	-	1000
Aschermann Martin, Eag	4	19	211					Barto Jeffrey, Hro	-	4	-	1000
Mikš Marián, Tem	1	5	200					Čuhel Lubomír, Tem	2	1	-	1000
Mánek Jakub, Hro	5	28	179					Kvapil Ondřej, Eag	-	3	-	1000
Kollár Martin, Hro	3	17	176					Tatar Martin, Hro	1	2	-	1000
Bužga Vojtěch, Eag	3	18	167					Vašourek Jan, Dra	-	3	-	1000
Vašourek František, Hro	3	20	150					Vykoukal Marko, Arr	-	3	-	1000
Sládek Jakub, Kot	4	28	143					Hegr Ondřej, Eag	-	2	-	1000
Šuran Martin, Tem	2	16	125					Hrušovský Karel, Dra	1	1	-	1000
Kocour Dan, Hro	1	9	111					Josefus Lukáš, Eag	1	1	-	1000
Sitár Jaroslav, Hro	1	12	083					Müller Michal, Kot	1	1	-	1000
Blažek Šimon, Eag	-	13	000					Navrátil Aleš, Arr	2	-	-	1000
Černý Daniel, Arr	-	13	000					Nebenfuhr Jan, Dra	1	1	-	1000
Kovala Tomáš, Arr	-	11	000					Novák Jan, Kot	1	1	-	1000
Kucin Jan, Hro	-	5	000					Ondra Tomáš, Arr	-	2	-	1000
Hrušovský Karel, Dra	-	4	000					Sobotka Michal, Dra	1	1	-	1000
Sobotka Jan, Tem	-	2	000					Ercoli Lukáš, Kot	-	1	-	1000
Ondra Tomáš, Arr	-	1	000					Grundmann Martin, Eag	-	1	-	1000
Schiefert Patrik, Tem	-	1	000					Šmidt Viktor, Eag	-	1	-	1000
Zajíček Adam, Tem	-	1	000					Ondroušek Dan, Hro	10	17	1	964
								Trunkát Lukáš, Hro	16	3	1	950
								Laube Martin, Eag	17	-	1	944
								Duffek Tomáš, Eag	1	15	1	941
								Mánek Jakub, Hro	16	-	1	941
								Kovala Tomáš, Arr	7	7	1	933
								Minařík Petr, Dra	2	11	1	929
								Polanský Tomáš, Dra	2	10	1	923
								Thurber Taylor, Eag	3	8	1	917
								Lukačka Martin, Tem	5	5	1	909
								Chroust Radim, Dra	3	4	1	875
								Tsurumaki Rio, Kot	7	-	1	875
								Bužga Vojtěch, Eag	3	20	4	852
								Kaplan Jakub, Arr	5	-	1	833
								Kucin Jan, Hro	3	2	1	833
								Šmoldas Martin, Arr	2	6	2	800
								Padyšák Daniel, Kot	3	19	6	786

Extraliga 2018 - nadstavba
Extra League 2018 - division Top6

<i>pálkař / hitter</i>	H	AB	BA	<i>nadhazovač/pitcher</i>	ER	IP	ERA	<i>poľař / fielder</i>	PO	A	E	FA
								Šulc Radek, Eag	3	6	3	750
								Mikš Marián, Tem	2	-	1	667
								Sobotka Jan, Tem	2	-	1	667
								Swagerty Stephen, Hro	-	2	1	667
								Vavruša Jiři, Kot	-	2	1	667
								Kraut Svatoslav, Hro	-	2	2	500
								Zajiček Adam, Tem	1	-	1	500
								Cihlář Josef, Kot	-	-	1	000

Extraliga 2018 - nadstavba
Extra League 2018 - post season



hráč player	pálka / batting																pole / fielding				nadhoz / pitching													
	G	AB	H	2B	3B	HR	SO	BB	HP	SH	SF	RBI	SB	CS	R	BA	SLG	OBP	PO	A	E	FA	G	CG	W	L	SV	IP	SO	R-	ER	W/L	ERA	
Draci Brno	20	676	199	34	5	12	121	87	15	7	8	120	26	7	155	294	413	383	508	202	20	973	20	2	16	4	5	171,0	152	70	64	800	3,37	
Budský Pavel	16	52	12	2	-	2	12	4	2	1	-	12	-	-	6	231	385	310	76	1	2	975	-	-	-	-	-	-	-	-	-	-	x	x
Čapka Filip	3	-	-	-	-	-	-	-	-	-	-	-	-	-	-	x	x	x	-	-	-	x	3	-	-	-	1	3,0	-	4	4	x	12,00	
Čech Petr	18	63	28	6	-	3	6	12	-	-	1	22	-	-	17	444	683	526	99	7	-	1000	-	-	-	-	-	-	-	-	-	x	x	
Červinka Martin	17	61	17	3	-	1	9	7	-	-	-	8	3	-	13	279	377	353	20	33	3	946	-	-	-	-	-	-	-	-	-	x	x	
Dubový Arnošt	20	86	29	4	1	2	17	8	-	1	1	11	5	1	26	337	477	389	46	1	-	1000	-	-	-	-	-	-	-	-	-	x	x	
Furko Ondřej	6	-	-	-	-	-	-	-	-	-	-	-	-	-	-	x	x	x	1	7	-	1000	6	-	2	1	1	23,1	10	14	14	667	5,40	
Hajtmar Jakub	20	70	14	2	-	-	17	12	2	-	-	7	3	1	14	200	229	333	26	49	6	926	-	-	-	-	-	-	-	-	-	x	x	
Hrušovský Karel	1	4	-	-	-	-	3	-	-	-	-	-	-	-	-	000	000	000	1	1	-	1000	-	-	-	-	-	-	-	-	-	x	x	
Hubbard Dondrei	19	79	24	3	1	1	6	5	2	-	3	16	6	1	21	304	405	348	66	21	1	989	-	-	-	-	-	-	-	-	-	x	x	
Hussey John	7	-	-	-	-	-	-	-	-	-	-	-	-	-	-	x	x	x	2	11	-	1000	7	2	5	1	-	41,2	43	13	11	833	2,38	
Chroust Přemek	20	77	32	4	-	3	7	7	3	-	1	24	3	1	17	416	584	477	93	12	2	981	-	-	-	-	-	-	-	-	-	x	x	
Chroust Radim	6	-	-	-	-	-	-	-	-	-	-	-	-	-	-	x	x	x	3	4	1	875	6	-	5	-	-	39,0	44	9	8	1000	1,85	
Kalábek Martin	16	34	4	1	-	-	9	1	-	1	1	5	1	-	4	118	147	139	16	1	-	1000	-	-	-	-	-	-	-	-	-	x	x	
Klanica Martin	4	1	1	-	-	-	-	-	-	-	-	-	-	-	-	1000	1000	1000	-	-	-	x	-	-	-	-	-	-	-	-	-	x	x	
Minařík Petr	7	-	-	-	-	-	-	-	-	-	-	-	-	-	-	x	x	x	2	11	1	929	7	-	3	-	2	23,2	23	9	7	1000	2,66	
Moštěk Filip	20	61	18	1	2	-	11	14	1	2	-	5	3	2	17	295	377	434	25	5	1	968	-	-	-	-	-	-	-	-	-	x	x	
Nebenfuhr Jan	7	-	-	-	-	-	-	-	-	-	-	-	-	-	-	x	x	x	1	1	-	1000	7	-	-	1	-	7,0	5	7	6	000	7,71	
Polanský Tomáš	14	43	10	4	-	-	11	6	1	1	-	2	-	1	8	233	326	340	2	10	1	923	-	-	-	-	-	-	-	-	-	x	x	
Řehůřek Lukáš	5	11	3	-	-	-	1	-	-	-	-	1	-	-	1	273	273	273	12	1	-	1000	-	-	-	-	-	-	-	-	-	x	x	
Schneider Martin	11	34	7	4	1	-	12	11	4	1	1	7	2	-	11	206	382	440	16	22	2	950	6	-	1	-	1	8,1	12	2	2	1000	2,16	
Sobotka Michal	6	-	-	-	-	-	-	-	-	-	-	-	-	-	-	x	x	x	1	1	-	1000	6	-	-	1	-	13,0	7	11	11	000	7,62	
Vašourek Jan	7	-	-	-	-	-	-	-	-	-	-	-	-	-	-	x	x	x	-	3	-	1000	7	-	-	-	-	12,0	8	1	1	x	0,75	

Extraliga 2018 - nadstavba
Extra League 2018 - post season



hráč player	pálka / batting																pole / fielding					nadhov / pitching											
	G	AB	H	2B	3B	HR	SO	BB	HP	SH	SF	RBI	SB	CS	R	BA	SLG	OBP	PO	A	E	FA	G	CG	W	L	SV	IP	SO	R-	ER	W/L	ERA
Arrows Ostrava	20	658	195	29	4	21	134	96	24	7	8	144	12	6	157	296	448	401	500	167	24	965	20	5	14	6	2	167,0	148	90	72	700	3,88
Bokaj Boris	7	-	-	-	-	-	-	-	-	-	-	-	-	-	-	x	x	x	2	10	-	1000	7	-	1	2	1	30,1	19	19	17	333	5,04
Burkholder Christop	8	1	1	-	-	-	-	-	-	-	-	-	-	-	-	1000	1000	1000	3	9	-	1000	7	2	2	1	-	39,2	41	19	15	667	3,40
Cipolla Anthony	18	62	16	3	1	-	18	2	1	-	1	9	-	1	10	258	339	288	22	33	4	932	-	-	-	-	-	-	-	-	-	x	x
Černý Daniel	4	11	-	-	-	-	4	2	-	-	-	-	-	-	2	000	000	154	3	-	-	1000	-	-	-	-	-	-	-	-	-	x	x
Grepl Jakub	19	60	18	4	1	1	12	10	-	3	-	6	2	-	13	300	450	400	40	35	8	904	-	-	-	-	-	-	-	-	-	x	x
Joyce Terrell	20	68	29	4	-	13	14	15	-	-	-	37	1	-	27	426	1059	530	48	1	2	961	-	-	-	-	-	-	-	-	-	x	x
Juněk Tomáš	16	62	17	2	-	3	8	7	1	1	-	13	2	1	12	274	452	357	111	8	4	967	-	-	-	-	-	-	-	-	-	x	x
Kaplan Jakub	7	11	3	1	-	-	2	3	1	-	1	1	-	-	3	273	364	438	5	-	1	833	-	-	-	-	-	-	-	-	-	x	x
Kovala Tomáš	6	11	-	-	-	-	6	1	1	1	-	-	1	-	-	000	000	154	7	7	1	933	-	-	-	-	-	-	-	-	-	x	x
Kubica Jakub	18	50	16	1	-	-	7	16	-	-	-	10	1	1	15	320	340	485	15	26	1	976	-	-	-	-	-	-	-	-	-	x	x
Malík Jakub	20	69	25	4	-	3	15	14	2	-	-	23	1	-	18	362	551	482	45	1	-	1000	-	-	-	-	-	-	-	-	-	x	x
Navrátil Aleš	14	41	14	1	-	1	5	1	2	-	-	5	-	2	2	341	439	386	2	-	-	1000	-	-	-	-	-	-	-	-	-	x	x
Novotný Radim	18	51	13	1	-	-	10	10	7	1	1	6	2	-	19	255	275	435	29	5	-	1000	-	-	-	-	-	-	-	-	-	x	x
Ondra Tomáš	7	1	-	-	-	-	-	-	-	-	-	-	-	-	-	000	000	000	-	2	-	1000	6	-	2	-	-	-	10	10	7	1000	3,26
Satoria Matěj	6	-	-	-	-	-	-	-	-	-	-	-	-	-	-	x	x	x	-	-	-	x	6	-	-	1	1	-	7	17	13	000	10,03
Satoria Ondřej	8	-	-	-	-	-	-	-	-	-	-	-	-	-	-	x	x	x	3	6	-	1000	8	-	4	1	-	-	31	15	12	800	3,90
Šmoldas Martin	6	19	6	1	-	-	6	1	1	-	-	6	1	-	3	316	368	381	2	6	2	800	-	-	-	-	-	-	-	-	-	x	x
Voják Jakub	19	65	16	3	1	-	14	11	8	-	1	11	1	-	23	246	323	412	57	6	-	1000	-	-	-	-	-	-	-	-	-	x	x
Vykoukal Marko	8	-	-	-	-	-	-	-	-	-	-	-	-	-	-	x	x	x	-	3	-	1000	8	3	5	1	-	-	40	10	8	833	1,88
Vykoukal Michael	19	76	21	4	1	-	13	3	-	1	4	17	-	1	10	276	355	289	106	9	1	991	-	-	-	-	-	-	-	-	-	x	x

Extraliga 2018 - nadstavba
Extra League 2018 - post season



hráč player	pálka / batting																pole / fielding				nadhov / pitching													
	G	AB	H	2B	3B	HR	SO	BB	HP	SH	SF	RBI	SB	CS	R	BA	SLG	OBP	PO	A	E	FA	G	CG	W	L	SV	IP	SO	R-	ER	W/L	ERA	
Eagles Praha	20	654	172	26	5	9	131	91	23	9	8	92	36	8	109	263	359	369	510	222	37	952	20	4	11	9	3	170,2	141	126	95	550	5,01	
Aschermann Martin	7	19	4	1	-	-	7	2	-	1	-	1	-	-	1	211	263	286	10	-	-	1000	-	-	-	-	-	-	-	-	-	-	x	x
Blažek Šimon	10	13	-	-	-	-	5	-	1	-	-	-	-	-	1	000	000	071	4	11	-	1000	2	-	-	-	-	10,0	3	5	5	x	4,50	
Bužga Vojtěch	10	18	3	1	-	-	6	2	-	-	-	-	1	-	3	167	222	250	3	20	4	852	5	-	1	1	1	8,2	15	3	3	500	3,12	
Duffek Tomáš	6	-	-	-	-	-	-	-	-	-	-	-	-	-	-	x	x	x	1	15	1	941	6	-	2	1	-	41,0	31	19	14	667	3,07	
Grundmann Martin	1	-	-	-	-	-	-	-	-	-	-	-	-	-	-	x	x	x	-	1	-	1000	1	-	-	1	-	1,1	2	4	4	000	27,00	
Hegr Ondřej	5	-	-	-	-	-	-	-	-	-	-	-	-	-	-	x	x	x	-	2	-	1000	5	-	-	-	-	6,0	3	11	11	x	16,50	
Hejma Matěj	17	58	22	3	2	5	16	12	1	-	4	23	4	-	15	379	759	467	38	1	2	951	-	-	-	-	-	-	-	-	-	x	x	
Homolka Jan	20	74	20	2	-	-	12	4	3	2	-	8	-	-	4	270	297	333	164	10	2	989	-	-	-	-	-	-	-	-	-	x	x	
Chlup Marek	12	47	13	3	1	2	9	6	1	-	-	8	3	1	10	277	511	370	30	1	1	969	-	-	-	-	-	-	-	-	-	x	x	
Chlup Vladimír	1	-	-	-	-	-	-	-	-	-	-	-	-	-	-	x	x	x	-	-	-	x	1	-	-	-	-	2,0	1	-	-	x	0,00	
Josefus Lukáš	5	-	-	-	-	-	-	-	-	-	-	-	-	-	-	x	x	x	1	1	-	1000	5	-	-	-	-	6,2	2	7	7	x	9,45	
Kvapil Ondřej	7	-	-	-	-	-	-	-	-	-	-	-	-	-	-	x	x	x	-	3	-	1000	7	-	2	-	1	9,2	3	1	1	1000	0,93	
Laube Martin	14	44	12	2	1	-	12	7	-	-	1	6	1	-	8	273	364	365	17	-	1	944	-	-	-	-	-	-	-	-	-	x	x	
Pojer Jan	19	73	19	4	-	-	10	9	1	1	-	4	2	-	17	260	315	349	27	2	-	1000	-	-	-	-	-	-	-	-	-	x	x	
Sandoval David	19	66	17	1	-	-	13	12	-	-	-	6	6	1	6	258	273	372	126	12	4	972	1	-	-	-	-	1,0	2	-	-	x	0,00	
Šmidt Viktor	5	-	-	-	-	-	-	-	-	-	-	-	-	-	-	x	x	x	-	1	-	1000	5	-	-	-	1	10,1	5	10	2	x	1,74	
Šulc Radek	15	51	14	2	-	-	10	4	2	-	1	8	4	2	6	275	314	345	3	6	3	750	-	-	-	-	-	-	-	-	-	x	x	
Thurber Taylor	9	-	-	-	-	-	-	-	-	-	-	-	-	-	-	x	x	x	3	8	1	917	9	3	5	3	-	-	49	40	28	625	5,07	
Wittig Joseph	18	48	13	3	-	-	4	11	8	-	-	4	6	2	12	271	333	478	10	28	8	826	5	1	1	3	-	-	25	26	20	250	7,40	
Zýma Michal	20	78	18	1	-	1	14	8	4	2	-	8	3	1	11	231	282	333	57	52	4	965	-	-	-	-	-	-	-	-	-	x	x	
Zýma Petr	20	65	17	3	1	1	13	14	2	3	2	16	6	1	15	262	385	398	16	48	6	914	-	-	-	-	-	-	-	-	-	x	x	

Extraliga 2018 - nadstavba
Extra League 2018 - post season



hráč player	pálka / batting														pole / fielding				nadhov / pitching															
	G	AB	H	2B	3B	HR	SO	BB	HP	SH	SF	RBI	SB	CS	R	BA	SLG	OBP	PO	A	E	FA	G	CG	W	L	SV	IP	SO	R-	ER	W/L	ERA	
Kotlářka Praha	20	682	208	38	4	23	125	92	13	9	6	129	23	11	152	305	474	395	504	171	32	955	20	4	10	10	1	168,0	155	127	109	500	5,84	
Aubrecht Ivan	11	38	19	3	-	-	5	4	-	2	1	11	2	1	10	500	579	535	16	-	-	1000	-	-	-	-	-	-	-	-	-	-	x	x
Blažka Ondřej	20	77	21	3	3	-	20	13	-	1	2	9	6	4	14	273	390	370	40	1	2	953	-	-	-	-	-	-	-	-	-	-	x	x
Brebner Jackson	18	48	15	5	-	1	3	2	2	-	-	9	2	-	10	313	479	365	33	10	1	977	6	1	2	2	-	30,0	28	15	14	500	4,20	
Cihlář Josef	7	-	-	-	-	-	-	-	-	-	-	-	-	-	-	x	x	x	-	-	1	000	7	-	1	1	1	15,1	15	21	18	500	10,57	
Ercoli Lukáš	6	-	-	-	-	-	-	-	-	-	-	-	-	-	-	x	x	x	-	1	-	1000	6	-	-	1	-	14,1	10	21	17	000	10,67	
Mulhearn Scott	20	80	24	5	-	2	6	10	1	-	1	13	1	-	20	300	438	380	37	32	3	958	6	-	2	1	-	23,0	12	13	12	667	4,70	
Müller Michal	2	4	1	1	-	-	2	-	-	-	-	1	-	-	1	250	500	250	1	1	-	1000	-	-	-	-	-	-	-	-	-	-	x	x
Mužik Martin	20	74	26	3	-	6	16	13	4	-	-	17	4	1	28	351	635	473	152	17	2	988	-	-	-	-	-	-	-	-	-	-	x	x
Novák Jan	7	-	-	-	-	-	-	-	-	-	-	-	-	-	-	x	x	x	1	1	-	1000	7	3	5	2	-	46,2	52	24	21	714	4,05	
Padyšák Daniel	14	31	8	2	-	-	13	6	-	1	-	5	1	-	7	258	323	378	3	19	6	786	6	-	-	2	-	18,0	15	11	7	000	3,50	
Puš Jáchym	16	54	8	1	-	-	11	8	1	2	-	4	1	1	6	148	167	270	13	29	5	894	-	-	-	-	-	-	-	-	-	-	x	x
Sládek Jakub	11	28	4	-	-	1	10	9	-	-	1	6	-	-	4	143	250	342	44	-	2	957	-	-	-	-	-	-	-	-	-	-	x	x
Smola Filip	10	33	10	1	-	-	4	6	-	1	-	5	4	-	4	303	333	410	17	36	2	964	-	-	-	-	-	-	-	-	-	-	x	x
Šůcha Matěj	20	72	23	4	-	4	16	6	4	1	1	21	-	1	12	319	542	398	42	-	1	977	-	-	-	-	-	-	-	-	-	-	x	x
Tsurumaki Rio	18	64	20	3	1	-	8	7	-	1	-	3	1	3	14	313	391	380	7	-	1	875	-	-	-	-	-	-	-	-	-	-	x	x
Vavruša Daniel	18	79	29	7	-	9	11	8	1	-	-	25	1	-	22	367	797	432	98	22	5	960	-	-	-	-	-	-	-	-	-	-	x	x
Vavruša Jiří	7	-	-	-	-	-	-	-	-	-	-	-	-	-	-	x	x	x	-	2	1	667	6	-	-	1	-	20,2	23	22	20	000	8,71	

Extraliga 2018 - nadstavba
Extra League 2018 - post season



hráč player	pálka / batting														pole / fielding						nadhaz / pitching												
	G	AB	H	2B	3B	HR	SO	BB	HP	SH	SF	RBI	SB	CS	R	BA	SLG	OBP	PO	A	E	FA	G	CG	W	L	SV	IP	K	R-	ER	W/L	ERA
Tempo Titans Praha	20	634	158	24	3	3	169	62	6	10	4	66	19	10	77	249	311	320	487	210	40	946	20	4	5	15	1	162,1	100	160	140	250	7,76
Bečka Vojtěch	2	4	1	-	-	-	1	-	-	-	-	1	-	1	-	250	250	250	2	4	-	1000	1	-	-	-	-	0,1	-	6	6	x	162,00
Bužga Matěj	17	50	9	-	2	-	12	7	1	1	-	3	2	1	6	180	260	293	47	2	1	980	-	-	-	-	-	-	-	-	-	x	x
Čuhel Lubomír	5	2	1	-	-	-	1	-	-	-	-	1	-	-	-	500	500	500	2	1	-	1000	5	-	-	-	-	8,2	4	15	14	x	14,54
Lukačka Martin	9	19	5	2	-	-	5	-	1	1	1	5	1	1	1	263	368	286	5	5	1	909	7	-	-	-	-	28,2	15	21	20	x	6,28
Martinez Christopher	15	50	10	3	1	-	12	3	1	-	-	5	2	1	4	200	300	259	17	31	4	923	-	-	-	-	-	-	-	-	-	x	x
Mikš Marián	4	5	1	-	-	-	3	-	-	-	-	-	-	-	-	200	200	200	2	-	1	667	-	-	-	-	-	-	-	-	-	x	x
Minařík Marek	19	56	22	4	-	2	14	2	2	-	-	10	3	2	6	393	571	433	21	5	5	839	5	-	-	5	18,0	17	27	23	000	11,50	
Nepomucký Aleš	20	56	10	1	-	-	23	8	-	3	-	2	4	-	5	179	196	281	44	3	1	979	-	-	-	-	-	-	-	-	-	x	x
Nevěřil David	20	61	15	3	-	-	13	16	1	-	-	3	3	-	21	246	295	410	26	33	5	922	6	1	1	3	28,1	6	20	17	250	5,40	
Pláteník Matěj	14	34	3	-	-	-	12	3	-	-	-	-	-	-	2	088	088	162	48	6	3	947	-	-	-	-	-	-	-	-	-	x	x
Rabinowitz Jake	20	64	20	2	-	-	16	12	-	-	1	11	2	1	7	313	344	416	13	37	3	943	9	3	3	4	1	57,2	47	22	18	429	2,81
Rejman Marek	15	48	9	1	-	-	10	4	-	2	-	7	-	-	2	188	208	250	97	7	1	990	-	-	-	-	-	-	-	-	-	x	x
Schiefert Patrik	2	1	-	-	-	-	1	-	-	-	-	-	-	1	-	000	000	000	-	-	-	x	-	-	-	-	-	-	-	-	-	x	x
Sobotka Jan	3	2	-	-	-	-	-	-	-	-	-	-	-	-	-	000	000	000	2	-	1	667	2	-	-	2	5,2	2	17	15	000	23,82	
Šuran Martin	10	16	2	1	-	-	10	1	-	-	-	-	-	-	2	125	188	176	11	-	-	1000	-	-	-	-	-	-	-	-	-	x	x
Šusta Petr	9	24	6	2	-	-	8	1	-	1	-	1	-	-	1	250	333	280	26	5	1	969	-	-	-	-	-	-	-	-	-	x	x
Vohánka David	19	75	26	3	-	-	7	4	-	1	1	6	1	1	12	347	387	375	24	54	9	897	7	-	1	1	15,0	9	32	27	500	16,20	
Zajíček Adam	1	1	-	-	-	-	1	-	-	-	-	-	-	-	-	000	000	000	1	-	1	500	-	-	-	-	-	-	-	-	-	x	x
Zelenka Martin	17	66	18	2	-	1	20	1	-	1	1	11	1	1	8	273	348	279	99	17	3	975	-	-	-	-	-	-	-	-	-	x	x



Extraliga 2018 - nadstavba
Extra League 2018 - post season

hráč player	pálka / batting														pole / fielding						nadhaz / pitching												
	G	AB	H	2B	3B	HR	SO	BB	HP	SH	SF	RBI	SB	CS	R	BA	SLG	OBP	PO	A	E	FA	G	CG	W	L	SV	IP	SO	R-	ER	W/L	ERA
Hroší Brno	20	642	163	22	3	9	141	66	10	10	4	67	26	5	80	254	340	331	485	175	31	955	20	2	4	16	3	162,1	125	147	128	200	7,10
Bareš Martin	5	-	-	-	-	-	-	-	-	-	-	-	-	-	-	x	x	x	-	-	-	x	5	-	-	2	-	8,2	7	16	16	000	16,62
Barto Jeffrey	7	-	-	-	-	-	-	-	-	-	-	-	-	-	-	x	x	x	-	4	-	1000	7	1	1	2	1	32,2	25	15	14	333	3,86
Claus Filip	14	43	7	1	-	-	12	4	2	-	-	2	-	1	-	163	186	265	42	6	1	980	-	-	-	-	-	-	-	-	-	x	x
Derhak Alexander	15	45	12	3	-	1	8	2	-	2	-	7	-	-	2	267	400	298	4	18	-	1000	3	-	-	1	-	3,2	3	11	11	000	27,00
Dvořák Martin	19	61	16	-	-	2	11	3	1	1	-	6	2	1	7	262	361	308	115	11	4	969	-	-	-	-	-	-	-	-	-	x	x
Jacques Adam	11	33	7	-	-	-	13	5	-	2	-	2	1	-	6	212	212	316	5	22	5	844	-	-	-	-	-	-	-	-	-	x	x
Kocour Dan	7	9	1	-	-	-	4	-	-	-	-	1	1	-	-	111	111	111	8	-	-	1000	-	-	-	-	-	-	-	-	-	x	x
Kollár Martin	6	17	3	-	-	-	2	3	1	-	-	3	-	-	3	176	176	333	10	2	-	1000	3	-	-	-	-	7,0	2	4	4	x	5,14
Kraut Svatoslav	5	-	-	-	-	-	-	-	-	-	-	-	-	-	-	x	x	x	-	2	2	500	5	-	-	1	-	11,1	10	8	4	000	3,18
Kremláček Michael	19	74	28	3	-	2	9	3	3	-	-	12	-	-	12	378	500	425	70	5	5	938	-	-	-	-	-	-	-	-	-	x	x
Kucin Jan	11	5	-	-	-	-	3	1	-	-	-	-	-	-	-	000	000	167	3	2	1	833	8	-	1	1	1	15,0	14	16	15	500	9,00
Mánek Jakub	10	28	5	1	-	-	11	-	-	-	-	2	2	-	1	179	214	179	16	-	1	941	-	-	-	-	-	-	-	-	-	x	x
Mc Dowall Kenneth	7	-	-	-	-	-	-	-	-	-	-	-	-	-	-	x	x	x	2	6	-	1000	7	1	1	5	-	43,2	43	29	21	167	4,33
Menšík Matěj	18	64	19	4	-	-	13	8	2	-	2	10	1	-	4	297	359	382	30	-	1	968	2	-	-	-	1	2,2	1	4	4	x	13,50
Menšík Vojtěch	12	45	10	-	2	2	10	7	-	2	-	8	3	-	6	222	444	327	24	20	2	957	-	-	-	-	-	-	-	-	-	x	x
Ondráček Jakub	20	69	17	3	-	1	12	8	1	1	1	4	9	3	13	246	333	329	45	49	4	959	-	-	-	-	-	-	-	-	-	x	x
Ondráček Michal	16	61	19	4	-	1	6	10	-	-	1	7	5	-	13	311	426	403	41	-	2	953	-	-	-	-	-	-	-	-	-	x	x
Ondroušek Dan	7	25	9	1	-	-	6	1	-	1	-	1	2	-	5	360	400	385	10	17	1	964	-	-	-	-	-	-	-	-	-	x	x
Sitár Jaroslav	5	12	1	-	-	-	3	2	-	-	-	-	-	-	1	083	083	214	18	2	-	1000	-	-	-	-	-	-	-	-	-	x	x
Swagerty Stephen	7	-	-	-	-	-	-	-	-	-	-	-	-	-	-	x	x	x	-	2	1	667	7	-	1	3	-	30,1	19	32	27	250	8,01
Tatar Martin	3	-	-	-	-	-	-	-	-	-	-	-	-	-	-	x	x	x	1	2	-	1000	3	-	-	-	-	5,1	-	9	9	x	15,19
Trunkát Lukáš	12	31	6	1	1	-	10	8	-	-	-	2	-	-	5	194	290	359	16	3	1	950	-	-	-	-	-	-	-	-	-	x	x
Vašourek František	11	20	3	1	-	-	8	1	-	1	-	-	-	-	2	150	200	190	25	2	-	1000	-	-	-	-	-	-	-	-	-	x	x
Wechsler Adam	2	-	-	-	-	-	-	-	-	-	-	-	-	-	-	x	x	x	-	-	-	x	2	-	-	1	-	2,0	1	3	3	000	13,50

Extraliga 2018 - play-off Extra League 2018 - play-off

Wild Series

Czech Series

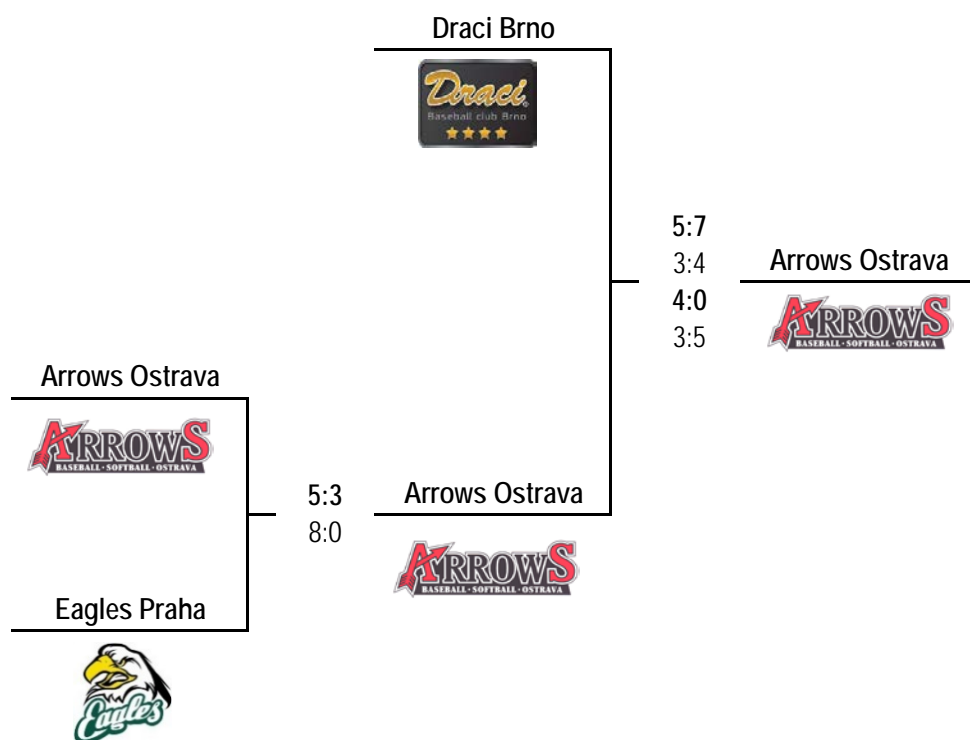

tučně jsou uvedena domácí utkání horního týmu
home games of the upper team are bold

Extraliga 2018 - play-off
Extra League 2018 - play-off

H	BA (AB»8)	HR	TB
7 Joyce Terrell, Arr	357 Schneider Martin, Dra	2 Joyce Terrell, Arr	15 Joyce Terrell, Arr
6 Juněk Tomáš, Arr	333 Joyce Terrell, Arr	1 Malík Jakub, Arr	10 Malík Jakub, Arr
6 Malík Jakub, Arr	308 Chroust Přemek, Dra		9 Voják Jakub, Arr
6 Ramirez Devon, Arr	300 Budský Pavel, Dra		8 Dubový Arnošt, Dra
6 Voják Jakub, Arr	273 Ramirez Devon, Arr		8 Ramirez Devon, Arr
5 Schneider Martin, Dra	261 Malík Jakub, Arr		7 Juněk Tomáš, Arr
5 Vykoukal Michael, Arr	261 Voják Jakub, Arr		6 Schneider Martin, Dra
4 5 hráčů / players	250 Juněk Tomáš, Arr		5 Chroust Přemek, Dra
	250 Vykoukal Michael, Arr		5 Vykoukal Michael, Arr
	250 Polanský Tomáš, Dra		4 6 hráčů / players
SLG (AB»8)	BB	OBP (AB+BB+HP+SF»9)	RBI
714 Joyce Terrell, Arr	4 Joyce Terrell, Arr	462 Joyce Terrell, Arr	6 Joyce Terrell, Arr
471 Dubový Arnošt, Dra	4 Polanský Tomáš, Dra	438 Polanský Tomáš, Dra	4 Malík Jakub, Arr
435 Malík Jakub, Arr	3 Vykoukal Michael, Arr	417 Budský Pavel, Dra	3 Dubový Arnošt, Dra
429 Schneider Martin, Dra	2 Grepl Jakub, Arr	400 Chroust Přemek, Dra	3 Kubica Jakub, Arr
391 Voják Jakub, Arr	2 Chroust Přemek, Dra	375 Schneider Martin, Dra	3 Ramirez Devon, Arr
385 Chroust Přemek, Dra	2 Ramirez Devon, Arr	348 Vykoukal Michael, Arr	2 8 hráčů / players
364 Ramirez Devon, Arr	2 Sandoval David, Eag	346 Malík Jakub, Arr	
333 Polanský Tomáš, Dra	1 13 hráčů / players	346 Ramirez Devon, Arr	
300 Budský Pavel, Dra		333 Červinka Martin, Dra	
292 Juněk Tomáš, Arr		300 Grepl Jakub, Arr	
SB	R	CG	W
2 Novotný Radim, Arr	6 Joyce Terrell, Arr	1 Burkholder Christ., Arr	3 Burkholder Chris, Arr
1 Bužga Vojtěch, Eag	4 Malík Jakub, Arr	1 Hussey John, Dra	1 Bokaj Boris, Arr
1 Cipolla Anthony, Arr	4 Ramirez Devon, Arr	1 Thurber Taylor, Eag	1 Minařík Petr, Dra
1 Dubový Arnošt, Dra	3 Juněk Tomáš, Arr		1 Satoria Ondřej, Arr
1 Hejma Matěj, Eag	3 Moštěk Filip, Dra		
1 Juněk Tomáš, Arr	3 Novotný Radim, Arr		
1 Kubica Jakub, Arr	3 Polanský Tomáš, Dra		
1 Ramirez Devon, Arr	3 Schneider Martin, Dra		
1 Vykoukal Michael, Arr	3 Voják Jakub, Arr		
1 Zýma Michal, Eag	3 Vykoukal Michael, Arr		
SAV	W/L (W+L»1)	IP	K
2 Vykoukal Marko, Arr	3-0 Burkholder Chris, Arr	22,2 Burkholder Chris, Arr	19 Burkholder Chris, Arr
1 Ondra Tomáš, Arr	1-0 Bokaj Boris, Arr	14,2 Hussey John, Dra	18 Hussey John, Dra
	1-0 Minařík Petr, Dra	12,2 Satoria Ondřej, Arr	10 Thurber Taylor, Eag
	1-1 Satoria Ondřej, Arr	8,0 Bokaj Boris, Arr	9 Bokaj Boris, Arr
	0-1 Duffek Tomáš, Eag	8,0 Thurber Taylor, Eag	9 Vykoukal Marko, Arr
	0-1 Chroust Radim, Dra	7,1 Minařík Petr, Dra	7 Minařík Petr, Dra
	0-1 Thurber Taylor, Eag	7,0 Chroust Radim, Dra	6 Wittig Joseph, Eag
	0-2 Hussey John, Dra	6,1 Vykoukal Marko, Arr	5 Satoria Ondřej, Arr
		5,2 Wittig Joseph, Eag	3 Chroust Radim, Dra
		4,0 Schneider Martin, Dra	2 3 hráči / players
ERA (IP»4,2)	PO	A	FA (PO+A+E»8)
0,00 Minařík Petr, Dra	42 Juněk Tomáš, Arr	18 Novotný Radim, Arr	45-0 Juněk Tomáš, Arr
0,71 Satoria Ondřej, Arr	30 Čech Petr, Dra	11 Grepl Jakub, Arr	34-0 Čech Petr, Dra
1,59 Wittig Joseph, Eag	26 Budský Pavel, Dra	9 Kubica Jakub, Arr	30-0 Budský Pavel, Dra
2,78 Burkholder Chris, Arr	26 Voják Jakub, Arr	9 Schneider Martin, Dra	28-0 Voják Jakub, Arr
2,84 Vykoukal Marko, Arr	23 Vykoukal Michael, Arr	8 Hajtmar Jakub, Dra	24-0 Vykoukal Michael, Arr
3,38 Bokaj Boris, Arr	19 Homolka Jan, Eag	5 Červinka Martin, Dra	20-0 Homolka Jan, Eag
3,68 Hussey John, Dra	17 Sandoval David, Eag	4 Budský Pavel, Dra	19-0 Sandoval David, Eag
4,50 Thurber Taylor, Eag	16 Grepl Jakub, Arr	4 Čech Petr, Dra	18-0 Malík Jakub, Arr
5,14 Chroust Radim, Dra	15 Malík Jakub, Arr	4 Hussey John, Dra	14-0 Ramirez Devon, Arr
	13 Ramirez Devon, Arr	4 Polanský Tomáš, Dra	11-0 2 hráči / players

Extraliga 2018 - play-off
Extra League 2018 - play-off

pálkař / hitter	H	AB	BA	nadhazovač/pitcher	ER	IP	ERA	polař / fielder	PO	A	E	FA
1 Schneider Martin, Dra	5	14	357	1 Minařík Petr, Dra	-	7,1	0,00	1 Juněk Tomáš, Arr	42	3	-	1000
2 Joyce Terrell, Arr	7	21	333	2 Satoria Ondřej, Arr	1	12,2	0,71	Čech Petr, Dra	30	4	-	1000
3 Chroust Přemek, Dra	4	13	308	3 Wittig Joseph, Eag	1	5,2	1,59	Budský Pavel, Dra	26	4	-	1000
4 Budský Pavel, Dra	3	10	300	4 Burkholder Christopfer, ,	7	22,2	2,78	Voják Jakub, Arr	26	2	-	1000
5 Ramirez Devon, Arr	6	22	273	5 Vykoukal Marko, Arr	2	6,1	2,84	Vykoukal Michael, Arr	23	1	-	1000
6 Malík Jakub, Arr	6	23	261	6 Bokaj Boris, Arr	3	8,0	3,38	Homolka Jan, Eag	19	1	-	1000
Voják Jakub, Arr	6	23	261	7 Hussey John, Dra	6	14,2	3,68	Sandoval David, Eag	17	2	-	1000
8 Juněk Tomáš, Arr	6	24	250	8 Thurber Taylor, Eag	4	8,0	4,50	Malík Jakub, Arr	15	3	-	1000
Vykoukal Michael, Arr	5	20	250	9 Chroust Radim, Dra	4	7,0	5,14	Ramirez Devon, Arr	13	1	-	1000
Polanský Tomáš, Dra	3	12	250	Schneider Martin, Dra	-	4,0	0,00	Dubový Arnošt, Dra	10	1	-	1000
11 Dubový Arnošt, Dra	4	17	235	Josefus Lukáš, Eag	-	1,1	0,00	Hajtmar Jakub, Dra	3	8	-	1000
Grepl Jakub, Arr	4	17	235	Sobotka Michal, Dra	-	1,0	0,00	Chroust Přemek, Dra	9	-	-	1000
13 Červinka Martin, Dra	2	9	222	Ondra Tomáš, Arr	1	3,1	2,70	Joyce Terrell, Arr	8	-	-	1000
14 Moštěk Filip, Dra	3	14	214	Duffek Tomáš, Eag	4	2,0	18,00	14 Grepl Jakub, Arr	16	11	1	964
15 Kubica Jakub, Arr	4	19	211					15 Schneider Martin, Dra	5	9	1	933
16 Hubbard Dondrei, Dra	3	16	188					16 Kubica Jakub, Arr	2	9	1	917
17 Novotný Radim, Arr	4	23	174					17 Hejma Matěj, Eag	9	-	1	900
18 Zýma Michal, Eag	1	9	111					18 Novotný Radim, Arr	10	18	4	875
19 Čech Petr, Dra	1	16	063					19 Moštěk Filip, Dra	6	-	2	750
Šulc Radek, Eag	2	6	333					20 Červinka Martin, Dra	1	5	3	667
Aschermann Martin, Eag	1	3	333					Hussey John, Dra	3	4	-	1000
Blažek Šimon, Eag	1	3	333					Hubbard Dondrei, Dra	6	-	-	1000
Hejma Matěj, Eag	2	7	286					Burkholder Christopfer, ,	1	2	-	1000
Zýma Petr, Eag	2	7	286					Chroust Radim, Dra	1	2	-	1000
Pojer Jan, Eag	1	5	200					Thurber Taylor, Eag	-	3	-	1000
Sandoval David, Eag	1	6	167					Bokaj Boris, Arr	-	2	-	1000
Hajtmar Jakub, Dra	-	7	000					Duffek Tomáš, Eag	-	2	-	1000
Homolka Jan, Eag	-	7	000					Kaplan Jakub, Arr	2	-	-	1000
Laube Martin, Eag	-	5	000					Minařík Petr, Dra	1	1	-	1000
Bužga Vojtěch, Eag	-	2	000					Pojer Jan, Eag	2	-	-	1000
Kaplan Jakub, Arr	-	1	000					Satoria Ondřej, Arr	1	1	-	1000
								Wittig Joseph, Eag	-	2	-	1000
								Aschermann Martin, Eag	1	-	-	1000
								Laube Martin, Eag	1	-	-	1000
								Zýma Petr, Eag	-	3	1	750
								Polanský Tomáš, Dra	-	4	2	667
								Zýma Michal, Eag	1	1	1	667
								Blažek Šimon, Eag	1	-	1	500
								Bužga Vojtěch, Eag	-	-	1	000

Extraliga 2018 - play-off
Extra League 2018 - play-off



hráč player	pálka / batting																pole / fielding				nadhaz / pitching												
	G	AB	H	2B	3B	HR	SO	BB	HP	SH	SF	RBI	SB	CS	R	BA	SLG	OBP	PO	A	E	FA	G	CG	W	L	SV	IP	SO	R-	ER	W/L	ERA
Arrows Ostrava	6	193	48	9	-	3	49	17	4	6	5	23	7	1	29	249	342	315	159	53	6	972	6	1	5	1	3	53,0	44	18	14	833	2,38
Bokaj Boris	2	-	-	-	-	-	-	-	-	-	-	-	-	-	-	x	x	x	-	2	-	1000	2	-	1	-	-	8,0	9	3	3	1000	3,38
Burkholder Christopfer	3	-	-	-	-	-	-	-	-	-	-	-	-	-	-	x	x	x	1	2	-	1000	3	1	3	-	22,2	19	9	7	1000	2,78	
Cipolla Anthony	1	-	-	-	-	-	-	1	-	-	-	-	1	-	-	x	x	1000	-	-	-	x	-	-	-	-	-	-	-	-	-	x	x
Grepl Jakub	6	17	4	-	-	-	7	2	-	2	1	1	-	-	1	235	235	300	16	11	1	964	-	-	-	-	-	-	-	-	-	x	x
Joyce Terrell	6	21	7	2	-	2	5	4	1	-	-	6	-	-	6	333	714	462	8	-	-	1000	-	-	-	-	-	-	-	-	-	x	x
Juněk Tomáš	6	24	6	1	-	-	8	1	-	-	-	2	1	1	3	250	292	280	42	3	-	1000	-	-	-	-	-	-	-	-	-	x	x
Kaplan Jakub	1	1	-	-	-	-	-	-	-	-	-	-	-	-	-	000	000	000	2	-	-	1000	-	-	-	-	-	-	-	-	-	x	x
Kubica Jakub	6	19	4	-	-	-	5	1	-	-	2	3	1	-	2	211	211	227	2	9	1	917	-	-	-	-	-	-	-	-	-	x	x
Malík Jakub	6	23	6	1	-	1	5	1	2	-	-	4	-	-	4	261	435	346	15	3	-	1000	-	-	-	-	-	-	-	-	-	x	x
Novotný Radim	6	23	4	-	-	-	8	1	-	2	-	-	2	-	3	174	174	208	10	18	4	875	-	-	-	-	-	-	-	-	-	x	x
Ondra Tomáš	2	-	-	-	-	-	-	-	-	-	-	-	-	-	-	x	x	x	-	-	-	x	2	-	-	-	1	3,1	2	1	1	x	2,70
Ramirez Devon	6	22	6	2	-	-	5	2	1	1	1	3	1	-	4	273	364	346	13	1	-	1000	-	-	-	-	-	-	-	-	-	x	x
Satoria Ondřej	2	-	-	-	-	-	-	-	-	-	-	-	-	-	-	x	x	x	1	1	-	1000	2	-	1	1	-	12,2	5	3	1	500	0,71
Voják Jakub	6	23	6	3	-	-	3	1	-	-	1	2	-	-	3	261	391	280	26	2	-	1000	-	-	-	-	-	-	-	-	-	x	x
Vykoukal Marko	3	-	-	-	-	-	-	-	-	-	-	-	-	-	-	x	x	x	-	-	-	x	3	-	-	-	2	6,1	9	2	2	x	2,84
Vykoukal Michael	6	20	5	-	-	-	3	3	-	1	-	2	1	-	3	250	250	348	23	1	-	1000	-	-	-	-	-	-	-	-	-	x	x

Extraliga 2018 - play-off
Extra League 2018 - play-off



hráč player	pálka / batting															pole / fielding					nadhaz / pitching														
	G	AB	H	2B	3B	HR	SO	BB	HP	SH	SF	RBI	SB	CS	R	BA	SLG	OBP	PO	A	E	FA	G	CG	W	L	SV	IP	SO	R-	ER	W/L	ERA		
Draci Brno	4	128	28	6	2	-	25	10	2	2	3	15	1	1	15	219	297	280	101	42	8	947	4	1	1	3	-	34,0	30	16	10	250	2,65		
Budský Pavel	3	10	3	-	-	-	1	1	1	-	-	2	-	-	-	300	300	417	26	4	-	1000	-	-	-	-	-	-	-	-	-	-	x	x	
Čech Petr	4	16	1	1	-	-	2	-	-	-	-	1	-	-	-	063	125	063	30	4	-	1000	-	-	-	-	-	-	-	-	-	-	x	x	
Červinka Martin	3	9	2	-	-	-	2	1	1	-	1	2	-	-	2	222	222	333	1	5	3	667	-	-	-	-	-	-	-	-	-	-	x	x	
Dubový Arnošt	4	17	4	-	2	-	4	-	-	1	-	3	1	-	2	235	471	235	10	1	-	1000	-	-	-	-	-	-	-	-	-	-	x	x	
Hajtmar Jakub	4	7	-	-	-	-	3	1	-	1	-	-	-	-	-	000	000	125	3	8	-	1000	-	-	-	-	-	-	-	-	-	-	x	x	
Hubbard Dondrei	4	16	3	1	-	-	-	-	-	-	1	2	-	1	1	188	250	176	6	-	-	1000	-	-	-	-	-	-	-	-	-	-	x	x	
Hussey John	2	-	-	-	-	-	-	-	-	-	-	-	-	-	-	x	x	x	3	4	-	1000	2	1	-	2	-	14,2	18	9	6	000	3,68		
Chroust Přemek	4	13	4	1	-	-	4	2	-	-	-	1	-	-	1	308	385	400	9	-	-	1000	-	-	-	-	-	-	-	-	-	-	x	x	
Chroust Radim	1	-	-	-	-	-	-	-	-	-	-	-	-	-	-	x	x	x	1	2	-	1000	1	-	-	1	-	7,0	3	7	4	000	5,14		
Minařík Petr	2	-	-	-	-	-	-	-	-	-	-	-	-	-	-	x	x	x	1	1	-	1000	2	-	1	-	-	7,1	7	-	-	1000	0,00		
Moštěk Filip	4	14	3	1	-	-	2	-	-	-	-	2	-	-	3	214	286	214	6	-	2	750	-	-	-	-	-	-	-	-	-	-	x	x	
Polanský Tomáš	4	12	3	1	-	-	3	4	-	-	-	-	-	-	3	250	333	438	-	4	2	667	-	-	-	-	-	-	-	-	-	-	-	x	x
Schneider Martin	4	14	5	1	-	-	4	1	-	-	1	2	-	-	3	357	429	375	5	9	1	933	2	-	-	-	-	4,0	2	-	-	-	-	x	0,00
Sobotka Michal	1	-	-	-	-	-	-	-	-	-	-	-	-	-	-	x	x	x	-	-	-	x	1	-	-	-	-	1,0	-	-	-	-	-	x	0,00

Extraliga 2018 - play-off
Extra League 2018 - play-off



hráč player	pálka / batting																pole / fielding				nadhov / pitching															
	G	AB	H	2B	3B	HR	SO	BB	HP	SH	SF	RBI	SB	CS	R	BA	SLG	OBP	PO	A	E	FA	G	CG	W	L	SV	IP	SO	R-	ER	W/L	ERA			
Eagles Praha	2	60	11	2	-	-	19	5	-	1	1	1	3	1	3	183	217	242	51	14	5	929	2	1	-	2	-	17,0	18	13	9	000	4,76			
Aschermann Martin	2	3	1	-	-	-	1	-	-	-	-	-	-	-	-	333	333	333	1	-	-	1000	-	-	-	-	-	-	-	-	-	x	x			
Blažek Šimon	1	3	1	-	-	-	-	-	-	-	-	-	-	-	-	333	333	333	1	-	1	500	-	-	-	-	-	-	-	-	-	x	x			
Bužga Vojtěch	1	2	-	-	-	-	2	1	-	1	-	-	1	-	-	000	000	333	-	-	1	000	-	-	-	-	-	-	-	-	-	x	x			
Duffek Tomáš	1	-	-	-	-	-	-	-	-	-	-	-	-	-	-	x	x	x	-	2	-	1000	1	-	-	1	-	2,0	2	4	4	000	18,00			
Hejma Matěj	2	7	2	1	-	-	4	1	-	-	-	-	1	-	2	286	429	375	9	-	1	900	-	-	-	-	-	-	-	-	-	x	x			
Homolka Jan	2	7	-	-	-	-	3	-	-	-	-	-	-	-	-	000	000	000	19	1	-	1000	-	-	-	-	-	-	-	-	-	-	x	x		
Josefus Lukáš	1	-	-	-	-	-	-	-	-	-	-	-	-	-	-	x	x	x	-	-	-	x	1	-	-	-	-	1,1	-	-	-	-	x	0,00		
Laube Martin	2	5	-	-	-	-	1	1	-	-	-	-	-	-	-	000	000	167	1	-	-	1000	-	-	-	-	-	-	-	-	-	-	x	x		
Pojer Jan	2	5	1	-	-	-	2	-	-	-	-	-	-	-	-	200	200	200	2	-	-	1000	-	-	-	-	-	-	-	-	-	-	-	x	x	
Sandoval David	2	6	1	-	-	-	-	2	-	-	-	-	-	1	-	167	167	375	17	2	-	1000	-	-	-	-	-	-	-	-	-	-	-	x	x	
Šulc Radek	2	6	2	-	-	-	1	-	-	-	1	1	-	-	-	333	333	286	-	-	-	x	-	-	-	-	-	-	-	-	-	-	-	x	x	
Thurber Taylor	1	-	-	-	-	-	-	-	-	-	-	-	-	-	-	x	x	x	-	3	-	1000	1	1	-	1	-	8,0	10	5	4	000	4,50			
Wittig Joseph	1	-	-	-	-	-	-	-	-	-	-	-	-	-	-	x	x	x	-	2	-	1000	1	-	-	-	-	5,2	6	4	1	x	1,59			
Zýma Michal	2	9	1	-	-	-	4	-	-	-	-	-	1	-	-	111	111	111	1	1	1	667	-	-	-	-	-	-	-	-	-	-	-	x	x	
Zýma Petr	2	7	2	1	-	-	1	-	-	-	-	-	-	-	1	286	429	286	-	3	1	750	-	-	-	-	-	-	-	-	-	-	-	-	x	x

Rozhodovaná utkání v Extralize 2018
Games umpired in Extra League 2018

Rozhodčí	Draci Brno		Technika Brno		Skokani Olomouc		Arrows Ostrava		Olympia Blansko		Eagles Praha	
	hlavní	metový	hlavní	metový	hlavní	metový	hlavní	metový	hlavní	metový	hlavní	metový
T. Adamec	-	5	-	2	-	1	-	1	-	1	-	-
V. Bartoš	-	-	1	1	2	1	-	-	-	1	1	1
O. Beneš	1	5	2	4	2	1	-	4	3	4	1	-
O. Bulvas	-	-	-	1	-	-	-	-	-	-	-	1
M. Dědek	-	1	-	1	1	-	-	-	-	-	-	2
R. Drápal	2	-	-	-	7	3	5	2	2	1	1	2
M. Dufek	-	-	1	2	-	2	-	1	2	3	-	-
M. Hadzima	-	-	-	2	-	-	1	1	-	-	-	-
R. Holcapfel	1	-	-	1	3	2	1	5	1	-	1	1
K. Jaksch	-	-	-	-	-	-	-	1	-	1	-	2
M. Jankovič	5	2	3	1	-	-	1	1	-	-	-	1
R. Kachtík	-	2	3	1	1	4	3	4	-	2	1	-
M. Kaigl	-	1	-	-	-	1	-	-	2	1	2	5
J. Kroupa	1	7	6	4	3	2	1	5	5	3	-	3
D. Kulhánek	5	3	-	4	2	1	-	-	3	3	-	2
J. Novota	-	-	-	-	-	-	1	-	-	-	-	-
J. Prokop	2	2	2	1	2	3	4	1	1	3	1	1
H. Prukner	1	1	-	-	-	-	-	-	-	-	-	-
F. Příbyl	-	1	1	-	-	-	1	2	1	-	3	2
V. Richter	-	-	-	-	-	1	1	1	1	2	5	4
M. Rotter	2	-	-	-	-	-	-	-	-	-	-	-
M. Rumler	-	2	-	2	-	1	1	-	1	2	-	-
B. Rychecký	-	-	1	1	1	1	-	-	-	1	2	2
R. Šimota	-	1	-	-	-	-	-	1	-	2	-	2
T. Špilauer	1	1	-	-	-	-	1	1	-	-	1	-
J. Tesařík	-	-	-	1	-	-	-	-	-	1	-	-
P. Toman	2	-	1	1	-	-	-	-	1	1	1	-
R. Vedlich	-	-	-	-	-	-	-	1	-	-	1	4
M. Vičar	5	4	5	3	4	4	7	-	3	-	3	-
Z. Židek	-	-	-	1	-	2	-	-	-	1	2	5
M. Živný	-	1	1	-	-	1	-	1	2	-	2	-
P. Toman	1	1	2	-	1	2	1	2	1	2	-	1
R. Tůma	-	-	-	-	-	-	-	-	-	-	-	1
R. Vedlich	-	-	-	-	-	-	-	2	-	-	-	-
M. Vičar	4	7	5	8	1	3	2	3	5	3	2	-
M. Zbožínek	-	-	-	1	-	-	-	1	-	-	-	-
M. Živný	-	4	1	1	1	1	-	-	2	1	-	2

Rozhodovaná utkání v Extralize 2018
Games umpired in Extra League 2018

Tempo Titans Praha		Nuclears Třebíč		Kotlářka Praha		Hroši Brno		Celkem	Rozhodčí		
hlavní	metový	hlavní	metový	hlavní	metový	hlavní	metový		hlavní	metový	Rozhodčí
-	1	-	1	-	2	-	8	11	-	11	T. Adamec
-	-	1	-	3	2	-	-	7	4	3	V. Bartoš
3	-	1	-	2	-	1	2	18	8	10	O. Beneš
-	-	-	-	-	-	-	-	1	-	1	O. Bulvas
1	1	-	-	-	1	-	2	5	1	4	M. Dědek
1	1	2	1	-	3	2	1	18	11	7	R. Drápal
-	1	1	-	-	1	-	-	7	2	5	M. Dufek
1	1	-	-	-	2	-	-	4	1	3	M. Hadzima
-	1	-	1	1	-	-	1	10	4	6	R. Holcapfel
-	1	-	2	-	3	-	-	5	-	5	K. Jaksch
-	-	2	-	2	2	3	3	13	8	5	M. Jankovič
-	-	1	2	1	-	-	1	13	5	8	R. Kachtík
2	1	1	-	2	1	1	-	10	5	5	M. Kaigl
2	1	3	1	-	-	5	2	27	13	14	J. Kroupa
1	-	1	1	1	1	3	1	16	8	8	D. Kulhánek
-	-	-	-	1	-	-	-	1	1	-	J. Novota
2	2	1	1	-	1	3	1	17	9	8	J. Prokop
-	-	1	3	-	1	-	1	4	1	3	H. Prukner
1	5	1	-	-	2	-	-	10	4	6	F. Přibyl
3	2	1	1	2	3	1	-	14	7	7	V. Richter
1	-	1	-	3	1	1	1	5	4	1	M. Rotter
-	2	-	2	-	1	2	2	9	2	7	M. Rumler
1	2	-	-	4	5	1	2	12	5	7	B. Rychecký
-	2	-	1	-	1	-	-	5	-	5	R. Šimota
1	1	-	2	-	-	-	1	5	2	3	T. Špilauer
-	-	-	1	-	-	-	1	2	-	2	J. Tesařík
-	1	3	3	-	-	-	-	7	4	3	P. Toman
2	2	-	1	1	3	-	1	8	2	6	R. Vedlich
3	4	4	1	3	1	3	1	29	20	9	M. Vičar
1	4	1	2	1	3	1	-	12	3	9	Z. Židek
1	-	2	3	-	-	-	-	7	4	3	M. Živný
-	-	6	9	1	1	3	4	19	8	11	P. Toman
-	2	-	-	-	1	-	-	2	-	2	R. Tůma
-	-	-	-	-	2	-	-	2	-	2	R. Vedlich
-	2	5	2	1	4	5	4	33	15	18	M. Vičar
-	-	-	-	-	-	-	-	1	-	1	M. Zbožínek
-	1	2	3	1	1	1	2	12	4	8	M. Živný

První liga 2018
League One 2018

1.	Sokol Hluboká	
2.	SaBaT Praha	
3.	Blesk Jablonec	
4.	Klasik Frýdek-Místek	
5.	Hroch z.s.	
6.	Pelikans Bučovice	
7.	Wolfs Domažlice	
8.	Orli Choceň	
9.	Sharks Spálené Poříčí	

První liga 2018 - základní část
League One 2018 - regular season

	SaBaT	Blesk	Hluboká	Klasik	Hroch	Wolfs	Orli	Pelikans	Sharks	G	W	L	S	PCT	R	R-
SaBaT Praha		18 - 15 7 - 8	9 - 6 9 - 0	11 - 5 11 - 2	5 - 1 17 - 6	18 - 6 18 - 2	12 - 1 16 - 1	18 - 6 9 - 3	29 - 0 22 - 7	16	15	1	0	938	229	69
Blesk Jablonec	15 - 18 8 - 7		0 - 15 7 - 5	17 - 10 10 - 7	6 - 10 17 - 7	24 - 5 15 - 0	23 - 0 17 - 2	22 - 12 22 - 5	25 - 2 33 - 2	16	13	3	0	813	261	107
Sokol Hluboká	6 - 9 0 - 9	15 - 0 5 - 7		12 - 11 4 - 12	12 - 1 9 - 6	15 - 5 8 - 4	20 - 8 13 - 3	19 - 9 22 - 4	29 - 2 20 - 1	16	12	3	1	750	209	91
Klasik FM	5 - 11 2 - 11	10 - 17 7 - 10	11 - 12 12 - 4		8 - 1 4 - 9	19 - 8 19 - 10	17 - 6 21 - 22	20 - 2 12 - 2	16 - 1 15 - 0	16	9	7	0	563	198	126
Hroch z.s.	1 - 5 6 - 17	10 - 6 7 - 17	1 - 12 6 - 9	1 - 8 9 - 4		17 - 0 27 - 12	4 - 9 25 - 8	17 - 4 11 - 3	15 - 0 14 - 2	16	9	7	0	563	171	116
Wolfs Domažlice	6 - 18 2 - 18	5 - 24 0 - 15	5 - 15 4 - 8	8 - 19 10 - 19	0 - 17 12 - 27		20 - 5 15 - 4	20 - 5 17 - 14	10 - 0 20 - 1	16	6	10	0	375	154	209
Orli Choceň	1 - 12 1 - 16	0 - 23 2 - 17	8 - 20 3 - 13	6 - 17 22 - 21	9 - 4 8 - 25	5 - 20 4 - 15		10 - 2 14 - 9	7 - 8 17 - 4	16	5	11	0	313	117	226
Pelikans Bučovice	6 - 18 3 - 9	12 - 22 5 - 22	9 - 19 4 - 22	2 - 20 2 - 12	4 - 17 3 - 11	5 - 20 14 - 17	2 - 10 9 - 14		21 - 4 26 - 13	16	2	14	0	125	127	250
Sharks Sp. Poříčí	0 - 29 7 - 22	2 - 25 2 - 33	2 - 29 1 - 20	1 - 16 0 - 15	0 - 15 2 - 14	0 - 10 1 - 20	8 - 7 4 - 17	4 - 21 13 - 26		16	1	15	0	063	47	319

tučně jsou uvedena domácí utkání
home games are bold

První liga 2018 - základní část
League One 2018 - regular season

H	BA (AB»20)	HR	TB
34 Herbster Quentin, Hlu	618 Herbster Quentin, Hlu	7 Dvořák Matěj, Hlu	57 Výbora Jonáš, Ble
29 Výbora Jonáš, Ble	547 Výbora Jonáš, Ble	7 Výbora Jonáš, Ble	53 Herbster Quentin, Hlu
27 Kříž Michal, SaB	531 Soukup Michal, Hlu	6 Výbora Jan, Ble	49 Soukup Michal, Hlu
26 Soukup Michal, Hlu	513 Škvařil Jan, SaB	5 Novák Ondřej, Dom	46 Weber Martin, Dom
24 Hon Ondřej, FrM	512 Tůma Jan, SaB	5 Weber Martin, Dom	45 Dvořák Matěj, Hlu
23 Černý Marek, SaB	500 Kachurka Aliaksei, Ble	4 Fous Matyáš, Ble	45 Novák Ondřej, Dom
23 Novák Ondřej, Dom	479 Černý Marek, SaB	4 Kaplan Jakub, FrM	44 Kříž Michal, SaB
23 Pekovič Michal, Dom	478 Weber Martin, Dom	3 5 hráčů / players	42 Fous Matyáš, Ble
22 5 hráčů / players	475 Výbora Jan, Ble		41 Výbora Jan, Ble
	474 Kříž Michal, SaB		41 Zhupanin Vasil, Hlu
SLG (AB»20)	BB	OBP (AB+BB+HP+SF»27)	RBI
1075 Výbora Jonáš, Ble	18 Výbora Jan, Ble	688 Výbora Jonáš, Ble	36 Soukup Michal, Hlu
1025 Výbora Jan, Ble	17 Vašourek František, Hrch	682 Herbster Quentin, Hlu	30 Výbora Jan, Ble
1000 Soukup Michal, Hlu	14 Novák Ondřej, Dom	643 Dupal Kryštof, SaB	27 Výbora Jonáš, Ble
1000 Weber Martin, Dom	14 Výbora Jan, Ble	629 Soukup Michal, Hlu	26 Dvořák Matěj, Hlu
964 Herbster Quentin, Hlu	13 Fous Matyáš, Ble	629 Výbora Jan, Ble	26 Weber Martin, Dom
918 Dvořák Matěj, Hlu	13 Hejný Stanislav, Hlu	609 Ševčík Tomáš, Ble	24 Kozel Matyáš, FrM
865 Novák Ondřej, Dom	13 Jiránek Vojtěch, Ble	593 Weber Martin, Dom	23 Černý Marek, SaB
846 Škvařil Jan, SaB	13 Míček Tomáš, FrM	589 Novák Ondřej, Dom	22 Škvařil Jan, SaB
804 Zhupanin Vasil, Hlu	13 Roubíček Lukáš, Ble	579 Novák Josef, Hlu	21 Hon Ondřej, FrM
792 Fous Matyáš, Ble	13 Ševčík Tomáš, Ble	578 Škvařil Jan, SaB	21 Vykoukal Tomáš, Buč
SB	R	CG	W
24 Novák Ondřej, Dom	36 Výbora Jonáš, Ble	2 Bříza Lukáš, Cho	4 Novák Josef, Hlu
20 Prantner Radek, SPo	34 Herbster Quentin, Hlu	2 Hernandez Alberto, Buč	3 Adamus Jindřich, FrM
14 Novák Pavel, Dom	32 Novák Ondřej, Dom	2 Hubálek Ondřej, Cho	3 Baker Michal, FrM
13 Mlsek Jiří, Hlu	31 Výbora Jan, Ble	2 Žondra Tomáš, Hrch	3 Kavan Petr, Ble
12 Kříž Michal, SaB	30 Kříž Michal, SaB	1 17 hráčů / players	3 Křepinský Vít, SaB
11 Dobruský Martin, Cho	28 Fous Matyáš, Ble		3 Petřina Jaroslav, SaB
11 Dvořák Matěj, Hlu	27 Míček Tomáš, FrM		3 Riedl Karel, Ble
11 Herbster Quentin, Hlu	25 Novák Pavel, Dom		3 Weber Martin, Dom
10 8 hráčů / players	24 Soukup Michal, Hlu		3 Zhupanin Vasil, Hlu
	22 2 hráči / players		2 10 hráčů / players
SAV	W/L (W+L»1)	IP	K
2 Pavelka Kamil, FrM	4-0 Novák Josef, Hlu	41,2 Bříza Lukáš, Cho	34 Zhupanin Vasil, Hlu
2 Procházka Matouš, SaB	3-0 Křepinský Vít, SaB	33,0 Baker Michal, FrM	30 Křepinský Vít, SaB
1 15 hráčů / players	3-0 Petřina Jaroslav, SaB	33,0 Novotný Petr, Hrch	29 Novák Josef, Hlu
	2-0 Dupal Kryštof, SaB	31,1 Křepinský Vít, SaB	28 Petřina Jaroslav, SaB
	2-0 Jelínek Filip, Hrch	30,0 Weber Martin, Dom	27 Kavan Petr, Ble
	2-0 Výbora Jan, Ble	29,2 Roubíček Lukáš, Ble	26 Žondra Tomáš, Hrch
	1-0 8 hráčů / players	28,1 Šrámek Alexander, SPo	24 Weber Martin, Dom
		26,2 Jelínek Filip, Hrch	22 Bříza Lukáš, Cho
		26,1 Vlach Vojtěch, Hlu	21 3 hráči / players
		25,1 2 hráči / players	
ERA (IP»8,1)	PO	A	FA (PO+A+E»21)
0,00 Dižck Rick, SaB	114 Vašourek František, Hrch	30 Výbora Jonáš, Ble	50-0 Kachurka Aliaksei, Ble
1,04 Procházka Matouš, SaB	70 Kříž Michal, SaB	28 Machačka Zdeněk, Ble	31-0 Drong Martin, FrM
1,50 Novák Josef, Hlu	69 Dvořák Matěj, Hlu	26 Janík Karel, Buč	28-0 Sobotka Martin, Hrch
1,80 Lukáš David, Hlu	68 Hon Ondřej, FrM	25 Cifra Marek, Cho	25-0 Kocour Dan, Hrch
2,57 Škvařil Jan, SaB	62 Novotný Petr, Cho	25 Petřina Jaroslav, SaB	24-0 Adamus Jindřich, FrM
3,38 Hejný Stanislav, Hlu	54 Klimovič Martin, Hlu	24 Miranda Kamil, Hlu	23-0 Kociřák Pavel, FrM
3,76 Vlach Vojtěch, Hlu	51 Bílek Tomáš, SaB	21 Výbora Jan, Ble	22-0 Fous Matyáš, Ble
4,02 Křepinský Vít, SaB	51 Mlsek Jiří, Hlu	20 Kříž Michal, SaB	983 Vašourek František, Hrch
4,12 Petřina Jaroslav, SaB	51 Tůma Jan, SaB	19 Dobruský Martin, Cho	982 Bílek Tomáš, SaB
4,15 Drong Martin, FrM	50 Kotrba Tomáš, Buč	18 5 hráčů / players	980 Pekovič Michal, Dom

První liga 2018 - základní část
League One 2018 - regular season

pákař / hitter	H	AB	BA	nadhazovač/pitcher	ER	IP	ERA	polař / fielder	PO	A	E	FA
1 Herbster Quentin, Hlu	34	55	618	1 Dijck Rick, SaB	-	9,0	0,00	1 Kachurka Aliaksei, Ble	44	6	-	1000
2 Výbora Jonáš, Ble	29	53	547	2 Procházka Matouš, SaB	1	8,2	1,04	Drong Martin, FrM	14	17	-	1000
3 Soukup Michal, Hlu	26	49	531	3 Novák Josef, Hlu	4	24,0	1,50	Sobotka Martin, Hrch	25	3	-	1000
4 Škvařil Jan, SaB	20	39	513	4 Lukáš David, Hlu	2	10,0	1,80	Kocour Dan, Hrch	23	2	-	1000
5 Tůma Jan, SaB	21	41	512	5 Škvařil Jan, SaB	4	14,0	2,57	Adamus Jindřich, FrM	22	2	-	1000
6 Kachurka Aliaksei, Ble	22	44	500	6 Hejný Stanislav, Hlu	4	10,2	3,38	Kociňák Pavel, FrM	21	2	-	1000
7 Černý Marek, SaB	23	48	479	7 Vlach Vojtěch, Hlu	11	26,1	3,76	Fous Matyáš, Ble	22	-	-	1000
8 Weber Martin, Dom	22	46	478	8 Křepinský Vít, SaB	14	31,1	4,02	8 Vašourek Frant., Hrch	114	5	2	983
9 Výbora Jan, Ble	19	40	475	9 Petřina Jaroslav, SaB	9	19,2	4,12	9 Bílek Tomáš, SaB	51	4	1	982
10 Kříž Michal, SaB	27	57	474	10 Drong Martin, FrM	6	13,0	4,15	10 Pekovič Michal, Dom	48	2	1	980
11 Uhnávý Jakub, Ble	18	39	462	11 Zhupanin Vasil, Hlu	11	22,1	4,43	11 Novák Pavel, Dom	46	3	1	980
12 Vykoukal Tomáš, Buč	17	38	447	12 Kavan Petr, Ble	13	25,1	4,62	12 Klimovič Martin, Hlu	54	17	2	973
13 Hon Ondřej, FrM	24	54	444	13 Riedl Karel, Ble	14	24,2	5,11	13 Kotrba Tomáš, Buč	50	13	2	969
14 Novák Ondřej, Dom	23	52	442	14 Roubíček Lukáš, Ble	17	29,2	5,16	14 Dluhoš Vladimír, Dom	27	4	1	969
15 Felkl Jan, Hrch	11	25	440	15 Baker Michal, FrM	19	33,0	5,18	Schneider Josef, Dom	28	3	1	969
16 Musil František, Ble	14	32	438	Novotný Petr, Hrch	19	33,0	5,18	16 Tůma Jan, SaB	51	1	2	963
Ševčík Tomáš, Ble	14	32	438	17 Výbora Jan, Ble	10	16,0	5,63	17 Hubálek Ondřej, Cho	16	9	1	962
18 Zhupanin Vasil, Hlu	22	51	431	18 Chocholouš Vít, Cho	12	19,0	5,68	Šonský Evžen, SaB	8	17	1	962
19 Prantner Radek, SPo	19	45	422	19 Jelínek Filip, Hrch	17	26,2	5,74	19 Dvořák Matěj, Hlu	69	2	3	959
20 Cífra Marek, Cho	13	31	419	20 Šimiček Jiří, FrM	6	9,1	5,79	20 Baker Michal, FrM	10	12	1	957
21 Fous Matyáš, Ble	22	53	415	21 Žondra Tomáš, Hrch	16	24,1	5,92	21 Neubauer Patrik, Hlu	19	2	1	955
22 Hanko Patrik, FrM	12	29	414	22 Adamus Jindřich, FrM	10	15,0	6,00	Svoboda Tomáš, Hrch	10	11	1	955
23 Petřina Jaroslav, SaB	16	39	410	23 Dupal Kryštof, SaB	13	17,1	6,75	23 Kouba Václav, Hlu	14	6	1	952
24 Urban Šimon, FrM	18	44	409	24 Kociňák Pavel, FrM	7	8,2	7,27	24 Petřina Jaroslav, SaB	12	25	2	949
Zikmunda Tomáš, Ble	9	22	409	25 Urban Šimon, FrM	13	14,0	8,36	25 Musil František, Ble	27	8	2	946
26 Dvořák Matěj, Hlu	20	49	408	26 Bříza Lukáš, Cho	39	41,2	8,42	26 Posolda Marek, Buč	45	6	3	944
27 Procházka Matouš, SaB	13	32	406	27 Janík Karel, Buč	25	25,1	8,88	27 Rovný Jan, Hrch	23	9	2	941
28 Sobotka Martin, Hrch	15	37	405	28 Hřib Jan, Hrch	24	20,2	10,45	28 Výbora Jan, Ble	26	21	3	940
29 Kadmas Ondřej, Cho	12	30	400	29 Weber Martin, Dom	36	30,0	10,80	29 Neufinger Lukáš, Hrch	49	11	4	938
Boda Michal, Hrch	8	20	400	30 Černý Michal, Dom	29	23,0	11,35	30 Drong Eduard, FrM	29	-	2	935
31 Lapiš Daniel, FrM	11	28	393	31 Hernandez Alberto, Buč	28	19,2	12,81	31 Hon Ondřej, FrM	68	4	5	935
32 Mencl Pavel, Ble	15	39	385	32 Chocholouš Petr, Cho	18	10,2	15,19	32 Mlsek Jiří, Hlu	51	6	4	934
Kolářek David, FrM	10	26	385	33 Vykoukal Ondřej, Buč	23	13,1	15,53	33 Cífra Marek, Cho	15	25	3	930
34 Pekovič Michal, Dom	23	60	383	34 Cífra Marek, Cho	25	13,0	17,31	34 Boda Michal, Hrch	8	18	2	929
35 Drong Martin, FrM	13	34	382	35 Skala Petr, Dom	31	16,0	17,44	35 Novák Ondřej, Dom	45	18	5	926
36 Kotrba Tomáš, Buč	16	42	381	36 Šrámek Alexander, SPo	55	28,1	17,47	Novotný Petr, Cho	62	1	5	926
37 Míček Tomáš, FrM	22	58	379	37 Hubálek Ondřej, Cho	36	18,0	18,00	37 Soukup Michal, Hlu	24	1	2	926
38 Hejný Stanislav, Hlu	14	37	378	38 Koudelka Vojtěch, Buč	20	9,1	19,29	38 Hejný Stanislav, Hlu	15	18	3	917
39 Koudelka Vojtěch, Buč	9	24	375	39 Hubený Vladimír, Dom	18	8,1	19,44	Ševčík Tomáš, Ble	20	2	2	917
40 Kozel Matyáš, FrM	20	54	370	40 Trávníček Lukáš, Dom	22	9,2	20,48	40 Kolářek David, FrM	28	4	3	914
41 Miranda Kamil, Hlu	17	46	370	41 Krejčí Libor, Buč	33	14,1	20,72	41 Machačka Zdeněk, Ble	46	28	7	914
42 Vybíral Michal, SPo	11	30	367	42 Vykoukal Tomáš, Buč	20	8,2	20,77	42 Andrie Michal, Cho	14	7	2	913
43 Jiránek Vojtěch, Ble	12	33	364	43 Šrámek Pavel, SPo	41	15,2	23,55	Bílek Jan, SaB	17	4	2	913
Zatloukal Aleš, SaB	12	33	364	44 Prantner Radek, SPo	54	15,1	31,70	44 Kříž Michal, SaB	70	20	9	909
45 Janderka Petr, Hrch	13	36	361	45 Vybíral Michal, SPo	66	13,0	45,69	45 Janík Karel, Buč	13	26	4	907
Kaplan Jakub, FrM	13	36	361	McCarthy Gregory, Dom	0	4,1	0,00	46 Bříza Lukáš, Cho	17	11	3	903
47 Novák Josef, Hlu	9	25	360	Pavelka Kamil, FrM	0	4,1	0,00	Skala Petr, Dom	22	6	3	903
48 Trávníček Lukáš, Dom	17	48	354	Kolářek David, FrM	0	3,0	0,00	48 Jelínek Filip, Hrch	13	14	3	900
49 Mlsek Jiří, Hlu	13	37	351	Kaplan Jakub, FrM	0	2,1	0,00	49 Uhnávý Jakub, Ble	43	1	5	898
50 Kocour Dan, Hrch	17	49	347	Helus Vít, SaB	0	2,0	0,00	50 Krejčí Libor, Buč	23	3	3	897
51 Novotný Petr, Cho	9	26	346	Šenk Filip, Hrch	0	2,0	0,00	51 Posolda Michal, Buč	18	7	3	893
52 Riedl Karel, Ble	11	32	344	Kouba Václav, Hlu	0	1,0	0,00	52 Vykoukal Ondřej, Buč	25	16	5	891
Šrut Martin, Cho	11	32	344	Kozel Matyáš, FrM	0	1,0	0,00	53 Dobruský Martin, Cho	36	19	7	887
54 Novák Pavel, Dom	20	60	333	Janderka Petr, Hrch	1	6,0	1,50	54 Felkl Jan, Hrch	11	12	3	885
Adamus Jindřich, FrM	12	36	333	Dobruský Martin, Cho	1	3,2	2,45	55 Prantner Radek, SPo	49	11	8	882

První liga 2018 - základní část
League One 2018 - regular season

pákař / hitter	H	AB	BA	nadhazovač/pitcher	ER	IP	ERA	polař / fielder	PO	A	E	FA
Posolda Michal, Buč	8	24	333	Hon Ondřej, FrM	2	6,0	3,00	56 Jiránek Vojtěch, Ble	27	2	4	879
57 Vašourek František, Hrc	19	59	322	Neubauer Patrik, Hlu	2	5,1	3,38	57 Kudláček Filip, Cho	34	2	5	878
58 Kudláček Filip, Cho	8	25	320	Dvořák Matěj, Hlu	3	6,0	4,50	58 Míček Tomáš, FrM	28	7	5	875
Neubauer Patrik, Hlu	8	25	320	Kudláček Filip, Cho	3	6,0	4,50	Weber Martin, Dom	18	10	4	875
Pospíchal Jiří, FrM	8	25	320	Kotek Jiří, SPo	5	7,0	6,43	Černý Michal, Dom	16	5	3	875
61 Bílek Tomáš, SaB	7	22	318	Šťastný David, Hlu	4	5,1	6,75	61 Šrámek Pavel, SPo	23	9	5	865
62 Gurník Ondřej, FrM	15	48	313	Volný Tomáš, FrM	4	4,2	7,71	62 Opršal Martin, Hrch	22	9	5	861
63 Krejčí Libor, Buč	12	39	308	Boček Tomáš, Hrch	2	2,1	7,71	63 Miranda Kamil, Hlu	13	24	6	860
64 Roubíček Lukáš, Ble	10	33	303	Výbora Jonáš, Ble	6	6,1	8,53	64 Kubečka Adam, Buč	41	8	8	860
65 Babor Martin, SaB	11	37	297	Hejtmánek Matěj, SaB	3	3,0	9,00	65 Vlach Vojtěch, Hlu	15	9	4	857
66 Dobruský Martin, Cho	12	41	293	Svoboda Jakub, Buč	3	2,2	10,13	Vykoukal Tomáš, Buč	12	12	4	857
67 Linhart Jakub, SPo	6	21	286	Kubečka Jakub, Buč	3	2,1	11,57	67 Gurník Ondřej, FrM	33	12	8	849
Svoboda Tomáš, Hrch	6	21	286	Zíka Pavel, SPo	7	5,0	12,60	68 Žufánek Jakub, Cho	33	-	6	846
Žufánek Jan, Cho	6	21	286	Foitzl Jiří, Buč	6	4,0	13,50	69 Šrámek Alexander, SPo	36	7	8	843
70 Andrlé Tomáš, Cho	12	43	279	Hasal Kryštof, SaB	4	2,0	18,00	70 Linhart Jakub, SPo	19	7	5	839
71 Kadoch David, Cho	9	33	273	Bílek Jan, SaB	2	1,0	18,00	71 Výbora Jonáš, Ble	26	30	11	836
72 Dluhoš Vladimír, Dom	10	37	270	Zikmunda Tomáš, Ble	10	4,1	20,77	72 Riedl Karel, Ble	12	16	6	824
Šrámek Pavel, SPo	10	37	270	Černý Lukáš, Dom	17	7,0	21,86	73 Roubíček Lukáš, Ble	14	18	7	821
74 Posolda Marek, Buč	11	41	268	Herbster Quentin, Hlu	12	4,2	23,14	74 Kaplan Jakub, FrM	15	15	7	811
75 Černý Michal, Dom	9	34	265	Černý Matěj, Dom	7	2,1	27,00	75 Shejbal Petr, Cho	8	9	4	810
76 Machačka Zdeněk, Ble	15	57	263	Šašek Petr, SPo	7	2,1	27,00	76 Kozel Matyáš, FrM	13	18	8	795
77 Šašek Petr, SPo	7	27	259	Novák Kryštof, SPo	6	2,0	27,00	77 Kadmas Ondřej, Cho	19	11	8	789
78 Vítek Adam, FrM	8	31	258	Žufánek Jakub, Cho	10	3,0	30,00	78 Andrlé Tomáš, Cho	21	3	7	774
79 Neufinger Lukáš, Hrch	12	49	245	Foitzl Jiří, Buč	13	3,0	39,00	79 Vítek Adam, FrM	8	9	5	773
80 Líkař Jan, Hlu	10	41	244	Kokošínský Martin, FrM	6	1,1	40,50	80 Zhupanin Vasil, Hlu	8	12	6	769
Opršal Martin, Hrch	10	41	244					81 Šrut Martin, Cho	26	6	10	762
82 Šrámek Alexander, SPo	12	50	240					82 Trávníček Lukáš, Dom	27	7	11	756
83 Kubečka Adam, Buč	11	46	239					83 Šašek Petr, SPo	15	10	9	735
84 Schneider Josef, Dom	7	30	233					84 Vybíral Michal, SPo	12	13	10	714
87 Křepinský Vít, SaB	6	28	214					Čížek Jiří, SPo	13	2	6	714
88 Čížek Jiří, SPo	5	24	208					88 Babor Martin, SaB	6	13	8	704
89 Foitzl Jiří, Buč	9	45	200					89 Kadoch David, Cho	6	7	8	619
Klimovič Martin, Hlu	8	40	200					Dupal Kryštof, SaB	10	8	-	1000
Vykoukal Ondřej, Buč	7	35	200					Šmehlík Daniel, Buč	15	2	-	1000
Kuryluk Petr, SPo	5	25	200					Černý Marek, SaB	14	1	-	1000
Němeček Jakub, SaB	5	25	200					Janderka Petr, Hrch	14	1	-	1000
Andrlé Michal, Cho	4	20	200					Němeček Jakub, SaB	14	-	-	1000
95 Žufánek Jakub, Cho	6	31	194					Kališ Radim, SPo	12	1	-	1000
96 Bříza Lukáš, Cho	5	28	179					Urban Šimon, FrM	7	6	-	1000
97 Čiháček Matouš, Buč	6	34	176					Škvařil Jan, SaB	10	1	-	1000
98 Mach Václav, Dom	7	41	171					Hanko Patrik, FrM	10	-	-	1000
99 Shejbal Petr, Cho	5	30	167					Hanuš Mikuláš, SaB	4	6	-	1000
100 Skala Petr, Dom	5	31	161					Křepinský Vít, SaB	8	2	-	1000
101 Tyc Matěj, Hlu	3	20	150					Černý Matěj, Dom	7	2	-	1000
102 Šonský Evžen, SaB	3	23	130					Mánek Jakub, Hrch	9	-	-	1000
103 Šmehlík Daniel, Buč	3	24	125					Hošna Filip, Hlu	5	3	-	1000
104 Jelínek Filip, Hrch	4	33	121					Pech Adolf, SPo	8	-	-	1000
105 Potštejnský Tomáš, Chc	1	21	048					Pirgl Michal, Hlu	7	1	-	1000
106 Linda Jiří, SPo	-	21	000					Svoboda Jakub, Buč	2	6	-	1000
Mikuš Lubomír, SPo	1	1	1000					Veleta Štěpán, SaB	7	1	-	1000
Georgiev Georgi, Buč	3	4	750					Kubečka Jakub, Buč	7	-	-	1000
Hasal Kryštof, SaB	3	4	750					Mencl Pavel, Ble	7	-	-	1000
Helus Vít, SaB	2	3	667					Hřib Jan, Hrch	-	6	-	1000
Jaroměřský Štěpán, SaB	2	3	667					Novák Kryštof, SPo	3	3	-	1000
Hejtmánek Matěj, SaB	9	14	643					Zatloukal Aleš, SaB	4	2	-	1000

První liga 2018 - základní část
League One 2018 - regular season

pálkař / hitter	H	AB	BA	nadhazovač/pitcher	ER	IP	ERA	polař / fielder	PO	A	E	FA
Foitzl Jiří, Buč	3	5	600					Peřina Šimon, SaB	2	3	-	1000
Kouba Václav, Hlu	8	16	500					Tůma David, SaB	5	-	-	1000
Mánek Jakub, Hrčh	7	14	500					McCarthy Gregory, Dom	4	-	-	1000
Bílek Jan, SaB	4	8	500					Pospíchal Jiří, FrM	4	-	-	1000
Sedláček Tomáš, Hrčh	4	8	500					Šimíček Jiří, FrM	3	1	-	1000
Souček Jakub, Ble	3	6	500					Daněk Martin, Hrčh	3	-	-	1000
Chavez Jose, Buč	2	4	500					Foitzl Jiří, Buč	3	-	-	1000
Mc Dowall Kenneth, Hrc	2	4	500					Ibn Ezra David, SaB	3	-	-	1000
Mikulášek Jan, Buč	2	4	500					Strádal Tomáš, Dom	3	-	-	1000
Štoudek Daniel, Hrčh	2	4	500					Žufánek Jan, Cho	3	-	-	1000
Šimíček Jiří, FrM	1	2	500					Boček Tomáš, Hrčh	2	-	-	1000
Žondra Tomáš, Hrčh	1	2	500					Černý Lukáš, Dom	1	1	-	1000
Fridrich Václav, SPo	5	11	455					Ell Jan, Cho	2	-	-	1000
Dupal Kryštof, SaB	8	18	444					Kavan Petr, Ble	1	1	-	1000
Hanuš Mikuláš, SaB	4	9	444					Mikuš Lubomír, SPo	2	-	-	1000
Kotek Jiří, SPo	3	7	429					Svida Viktor, Hrčh	2	-	-	1000
Pavelka Kamil, FrM	2	5	400					Tyc Matěj, Hlu	2	-	-	1000
Geryk Jakub, FrM	7	18	389					Žondra Tomáš, Hrčh	1	1	-	1000
Baker Michal, FrM	5	13	385					Dijck Rick, SaB	-	1	-	1000
Tůma David, SaB	5	13	385					Hasal Kryštof, SaB	-	1	-	1000
Kociňák Pavel, FrM	3	9	333					Chocholouš Petr, Cho	-	1	-	1000
Kukrál Tomáš, Hlu	2	6	333					Kotek Jiří, SPo	-	1	-	1000
McCarthy Gregory, Dorr	2	6	333					Kukrál Tomáš, Hlu	1	-	-	1000
Mitáček Matěj, Ble	2	6	333					Lukáš David, Hlu	1	-	-	1000
Novák Kryštof, SPo	2	6	333					Rutta Jindřich, Hrčh	1	-	-	1000
Chocholouš Vít, Cho	1	3	333					Whitehead Raymond, Hrc	1	-	-	1000
Macík Lukáš, Hrčh	1	3	333					Herbster Quentin, Hlu	14	-	1	933
Sedláček Milan, Buč	1	3	333					Chocholouš Vít, Cho	10	4	1	933
Hořna Filip, Hlu	4	14	286					Líkař Jan, Hlu	13	1	1	933
Janík Karel, Buč	4	14	286					Mach Václav, Dom	10	1	1	917
Kališ Radim, SPo	2	7	286					Linhart Matěj, SPo	9	-	1	900
Marek Michal, Hlu	2	7	286					Sedláček Tomáš, Hrčh	6	3	1	900
Vojta Petr, Hlu	2	7	286					Koudelka Vojtěch, Buč	12	4	2	889
Zumr Petr, Ble	2	7	286					Lapiš Daniel, FrM	6	2	1	889
Novotný Petr, Hrčh	3	11	273					Novotný Lukáš, Hrčh	2	6	1	889
Drong Eduard, FrM	4	15	267					Potštejnský Tomáš, Cho	7	1	1	889
Tvrz Daniel, SaB	3	12	250					Pavelka Kamil, FrM	13	2	2	882
Čudovský Jakub, Hrčh	1	4	250					Tvrz Daniel, SaB	5	2	1	875
Hříb Jan, Hrčh	1	4	250					Novák Josef, Hlu	8	5	2	867
Kalandra Ondřej, Hrčh	1	4	250					Čudovský Jakub, Hrčh	3	3	1	857
Veleta Štěpán, SaB	1	4	250					Hubený Vladimír, Dom	6	-	1	857
Whitehead Raymond, H	1	4	250					Šrámek Pavel st, SPo	5	1	1	857
Šenk Filip, Hrčh	4	17	235					Hejtmánek Matěj, SaB	10	1	2	846
Boček Tomáš, Hrčh	3	13	231					Christoph Lukáš, Cho	4	1	1	833
Ibn Ezra David, SaB	3	14	214					Kuryluk Petr, SPo	5	-	1	833
Ell Jan, Cho	4	19	211					Novotný Petr, Hrčh	6	3	2	818
Hubálek Ondřej, Cho	4	19	211					Vojta Petr, Hlu	9	4	3	813
Vlach Vojtěch, Hlu	4	19	211					Foitzl Jiří, Buč	12	-	3	800
Christoph Lukáš, Cho	2	10	200					Čiháček Matouš, Buč	7	1	2	800
Peřina Šimon, SaB	1	5	200					Procházka Matouš, SaB	6	2	2	800
Rovný Jan, Hrčh	3	17	176					Zikmunda Tomáš, Ble	7	1	2	800
Daněk Martin, Hrčh	2	13	154					Šenk Filip, Hrčh	5	2	2	778
Jeřábek Jaroslav, Cho	2	14	143					Fridrich Václav, SPo	12	1	4	765
Linhart Matěj, SPo	2	14	143					Kalandra Ondřej, Hrčh	1	2	1	750
Kučera Michal, SPo	1	7	143					Šmoldas Martin, FrM	3	-	1	750

První liga 2018 - základní část
League One 2018 - regular season

pálkař / hitter	H	AB	BA	nadhazovač/pitcher	ER	IP	ERA	polař / fielder	PO	A	E	FA
Svída Viktor, Hrch	2	15	133					Šťastný David, Hlu	1	2	1	750
Novotný Lukaš, Hrch	2	16	125					Geryk Jakub, FrM	1	4	2	714
Pech Adolf, SPo	2	16	125					Hernandez Alberto, Buč	3	2	2	714
Černý Matěj, Dom	1	8	125					Jeřábek Jaroslav, Cho	5	-	2	714
Svoboda Jakub, Buč	1	12	083					Štoudek Daniel, Hrch	1	3	2	667
Hubený Vladimír, Dom	1	13	077					Samek Matěj, Hrch	2	-	1	667
Chocholouš Petr, Cho	0	8	0					Vykoukal Lubomír, Buč	2	0	1	667
Hartl Tomáš, Dom	0	5	0					Kučera Michal, SPo	5	0	3	625
Šrámek Pavel st, SPo	0	5	0					Souček Jakub, Ble	2	1	3	500
Hernandez Alberto, Buč	0	3	0					Zumr Petr, Ble	1	0	1	500
Paur Lukáš, SPo	0	3	0					Linda Jiří, SPo	4	1	8	385
Samek Matěj, Hrch	0	3	0					Jaroměřský Štěp., SaB	0	0	2	0
Šmoldas Martin, FrM	0	3	0					Marek Michal, Hlu	0	0	2	0
Vykoukal Lubomír, Buč	0	3	0									
Černý Lukáš, Dom	0	2	0									
Konečný Marek, FrM	0	2	0									
Pirgl Michal, Hlu	0	2	0									
Strádal Tomáš, Dom	0	2	0									

První liga 2018 - základní část
League One 2018 - regular season



hráč player	pálka / batting																pole / fielding					nadhoz / pitching														
	G	AB	H	2B	3B	HR	SO	BB	HP	SH	SF	RBI	SB	CS	R	BA	SLG	OBP	PO	A	E	FA	G	CG	W	L	SV	IP	SO	R-	ER	W/L	ERA			
SaBaT Praha	13	531	209	38	10	10	62	90	18	3	4	160	75	7	224	394	559	493	317	115	32	931	13	1	12	1	3	108,0	131	74	50	923	4,17			
Babor Martin	11	37	11	2	-	1	5	8	1	1	-	9	3	-	13	297	432	435	6	13	8	704	-	-	-	-	-	-	-	-	-	x	x			
Bílek Jan	3	8	4	-	-	-	-	1	-	-	-	2	1	-	2	500	500	556	17	4	2	913	1	-	-	-	-	1,0	-	2	2	x	18,00			
Bílek Tomáš	7	22	7	-	-	-	-	6	1	-	-	3	3	1	9	318	318	483	51	4	1	982	-	-	-	-	-	-	-	-	-	x	x			
Černý Marek	14	48	23	4	1	2	11	12	-	-	1	23	4	-	21	479	729	574	14	1	-	1000	-	-	-	-	-	-	-	-	-	x	x			
Dijck Rick	1	-	-	-	-	-	-	-	-	-	-	-	-	-	-	x	x	x	-	1	-	1000	1	1	-	-	-	9,0	17	1	-	x	0,00			
Dupal Kryštof	10	18	8	-	-	1	3	5	5	-	-	8	3	1	8	444	611	643	10	8	-	1000	5	-	2	-	-	17,1	17	15	13	1000	6,75			
Hanuš Mikuláš	3	9	4	2	-	1	-	2	-	1	-	5	-	-	5	444	1000	545	4	6	-	1000	-	-	-	-	-	-	-	-	-	x	x			
Hasal Kryštof	2	4	3	-	2	-	-	-	-	-	-	4	-	-	2	750	1750	750	-	1	-	1000	1	-	1	-	-	2,0	2	5	4	1000	18,00			
Hejtmánek Matěj	4	14	9	3	-	1	-	1	1	-	-	7	2	1	5	643	1071	688	10	1	2	846	1	-	-	-	1	3,0	2	3	3	x	9,00			
Helus Vít	2	3	2	-	-	-	-	-	-	-	-	1	-	-	3	667	667	667	-	-	-	x	1	-	-	-	-	2,0	3	-	-	x	0,00			
Ibn Ezra David	6	14	3	-	-	-	3	2	-	-	-	4	4	-	6	214	214	313	3	-	-	1000	-	-	-	-	-	-	-	-	-	x	x			
Jaroměřský Štěpán	2	3	2	1	-	-	1	-	-	-	-	1	-	-	1	667	1000	667	-	-	2	000	-	-	-	-	-	-	-	-	-	x	x			
Křepinský Vít	10	28	6	1	-	-	3	1	2	-	2	4	1	1	4	214	250	273	8	2	-	1000	7	-	3	-	-	31,1	30	25	14	1000	4,02			
Kříž Michal	14	57	27	6	4	1	10	8	2	-	1	16	12	1	30	474	772	544	70	20	9	909	-	-	-	-	-	-	-	-	-	x	x			
Němeček Jakub	10	25	5	-	-	-	6	7	1	-	-	5	3	-	10	200	200	394	14	-	-	1000	-	-	-	-	-	-	-	-	-	-	x	x		
Peřina Šimon	1	5	1	-	-	-	-	-	-	-	-	1	-	-	3	200	200	200	2	3	-	1000	-	-	-	-	-	-	-	-	-	-	x	x		
Petřina Jaroslav	13	39	16	3	-	-	1	7	-	1	-	6	10	1	15	410	487	500	12	25	2	949	5	-	3	-	-	19,2	28	11	9	1000	4,12			
Procházka Matouš	10	32	13	3	1	-	2	11	1	-	-	6	5	-	18	406	563	568	6	2	2	800	3	-	1	-	2	8,2	15	2	1	1000	1,04			
Škvařil Jan	12	39	20	5	1	2	4	5	1	-	-	22	8	1	22	513	846	578	10	1	-	1000	5	-	2	1	-	14,0	17	10	4	667	2,57			
Šonský Evžen	8	23	3	-	-	-	2	3	1	-	-	2	4	-	6	130	130	259	8	17	1	962	-	-	-	-	-	-	-	-	-	-	x	x		
Tůma David	5	13	5	3	-	-	2	2	1	-	-	5	-	-	6	385	615	500	5	-	-	1000	-	-	-	-	-	-	-	-	-	-	-	x	x	
Tůma Jan	9	41	21	4	1	1	4	1	-	-	-	18	5	-	15	512	732	524	51	1	2	963	-	-	-	-	-	-	-	-	-	-	-	x	x	
Tvrz Daniel	4	12	3	1	-	-	5	6	-	-	-	1	2	-	4	250	333	500	5	2	1	875	-	-	-	-	-	-	-	-	-	-	-	x	x	
Veleta Štěpán	1	4	1	-	-	-	-	-	-	-	-	1	-	-	1	250	250	250	7	1	-	1000	-	-	-	-	-	-	-	-	-	-	-	-	x	x
Zatloukal Aleš	10	33	12	-	-	-	-	2	1	-	-	6	5	-	15	364	364	417	4	2	-	1000	-	-	-	-	-	-	-	-	-	-	-	-	x	x



První liga 2018 - základní část
League One 2018 - regular season

hráč player	pálka / batting															pole / fielding					nadhoz / pitching														
	G	AB	H	2B	3B	HR	SO	BB	HP	SH	SF	RBI	SB	CS	R	BA	SLG	OBP	PO	A	E	FA	G	CG	W	L	SV	IP	SO	R-	ER	W/L	ERA		
Blesk Jablonec	15	528	217	56	8	25	74	135	24	2	9	61	206	5	261	411	689	540	325	135	53	897	15	3	12	3	2	106,1	90	105	70	800	5,92		
Fous Matyáš	14	53	22	-	4	4	12	13	1	-	-	9	15	-	28	415	792	537	22	-	-	1000	-	-	-	-	-	-	-	-	-	-	x	x	
Jiránek Vojtěch	11	33	12	3	-	-	6	13	-	-	-	4	12	-	14	364	455	543	27	2	4	879	-	-	-	-	-	-	-	-	-	-	x	x	
Kachurka Aliaksei	12	44	22	11	-	-	5	7	2	1	4	8	20	-	17	500	750	544	44	6	-	1000	-	-	-	-	-	-	-	-	-	-	x	x	
Kavan Petr	7	-	-	-	-	-	-	-	-	-	-	-	-	-	-	x	x	x	1	1	-	1000	7	1	3	1	-	25,1	27	28	13	750	4,62		
Machačka Zdeněk	14	57	15	6	1	2	6	5	1	-	-	5	16	-	17	263	509	333	46	28	7	914	-	-	-	-	-	-	-	-	-	-	x	x	
Mencl Pavel	12	39	15	4	-	-	3	11	3	-	-	4	9	1	17	385	487	547	7	-	-	1000	-	-	-	-	-	-	-	-	-	-	x	x	
Mitáček Matěj	1	6	2	-	-	-	1	-	-	-	-	-	-	-	2	333	333	333	-	-	-	x	-	-	-	-	-	-	-	-	-	-	x	x	
Musil František	9	32	14	6	-	1	6	10	1	-	1	1	14	-	19	438	719	568	27	8	2	946	-	-	-	-	-	-	-	-	-	-	x	x	
Riedl Karel	15	32	11	4	-	-	7	5	-	-	1	8	4	-	15	344	469	421	12	16	6	824	8	1	3	1	1	24,2	18	19	14	750	5,11		
Roubíček Lukáš	14	33	10	3	-	3	9	13	-	-	-	1	17	-	18	303	667	500	14	18	7	821	5	1	2	1	-	29,2	17	24	17	667	5,16		
Souček Jakub	2	6	3	1	-	-	-	1	-	-	-	-	2	-	4	500	667	571	2	1	3	500	-	-	-	-	-	-	-	-	-	-	x	x	
Ševčík Tomáš	11	32	14	5	-	-	6	13	1	-	-	3	10	1	18	438	594	609	20	2	2	917	-	-	-	-	-	-	-	-	-	-	-	x	x
Uhnavý Jakub	10	39	18	1	2	1	7	3	-	-	-	7	15	-	14	462	667	500	43	1	5	898	-	-	-	-	-	-	-	-	-	-	-	x	x
Výbora Jan	14	40	19	2	1	6	2	18	2	-	2	2	30	-	31	475	1025	629	26	21	3	940	6	-	2	-	1	16,0	21	17	10	1000	5,63		
Výbora Jonáš	16	53	29	7	-	7	3	14	12	-	1	8	27	2	36	547	1075	688	26	30	11	836	3	-	1	-	-	6,1	4	6	6	1000	8,53		
Zikmunda Tomáš	10	22	9	3	-	1	-	4	-	1	-	1	12	1	6	409	682	500	7	1	2	800	3	-	1	-	-	4,1	3	11	10	1000	20,77		
Zumr Petr	3	7	2	-	-	-	1	5	1	-	-	-	3	-	5	286	286	615	1	-	1	500	-	-	-	-	-	-	-	-	-	-	-	x	x



První liga 2018 - základní část

League One 2018 - regular season

hráč player	pálka / batting														pole / fielding						nadhaz / pitching												
	G	AB	H	2B	3B	HR	SO	BB	HP	SH	SF	RBI	SB	CS	R	BA	SLG	OBP	PO	A	E	FA	G	CG	W	L	SV	IP	SO	R-	ER	W/L	ERA
Sokol Hluboká	13	546	206	52	6	17	78	106	29	4	2	173	100	8	218	377	588	499	343	113	42	916	13	3	10	3	3	115,2	114	92	53	769	4,12
Dvořák Matěj	14	49	20	4	-	7	2	9	-	-	-	26	11	-	17	408	918	500	69	2	3	959	1	-	-	-	-	6,0	5	3	3	x	4,50
Hejný Stanislav	13	37	14	2	-	1	4	13	-	-	-	11	10	-	15	378	514	540	15	18	3	917	5	-	-	-	1	10,2	13	6	4	x	3,38
Herbster Quentin	15	55	34	13	-	2	2	8	3	-	-	19	11	2	34	618	964	682	14	-	1	933	3	-	-	-	-	4,2	3	13	12	x	23,14
Hošna Filip	5	14	4	-	-	-	1	4	4	-	-	-	5	1	7	286	286	545	5	3	-	1000	-	-	-	-	-	-	-	-	-	x	x
Klimovič Martin	15	40	8	1	-	-	9	9	3	3	-	6	5	1	15	200	225	385	54	17	2	973	-	-	-	-	-	-	-	-	-	x	x
Kouba Václav	5	16	8	1	1	-	2	2	1	-	-	6	7	-	6	500	688	579	14	6	1	952	1	-	-	-	-	1,0	3	-	-	x	0,00
Kukrál Tomáš	4	6	2	-	-	-	3	4	-	-	-	-	1	-	4	333	333	600	1	-	-	1000	-	-	-	-	-	-	-	-	-	x	x
Líkař Jan	13	41	10	1	-	-	8	7	4	-	1	9	2	-	10	244	268	396	13	1	1	933	-	-	-	-	-	-	-	-	-	x	x
Lukáš David	2	-	-	-	-	-	-	-	-	-	-	-	-	-	-	x	x	x	1	-	-	1000	2	1	1	-	-	10,0	10	10	2	1000	1,80
Marek Michal	3	7	2	-	-	-	3	-	-	-	-	1	-	-	-	286	286	286	-	-	2	000	-	-	-	-	-	-	-	-	-	x	x
Miranda Kamil	12	46	17	6	1	-	6	6	7	-	-	13	2	1	21	370	543	508	13	24	6	860	-	-	-	-	-	-	-	-	-	x	x
Mlsek Jiří	10	37	13	1	-	-	-	2	1	-	1	3	13	2	15	351	378	390	51	6	4	934	-	-	-	-	-	-	-	-	-	x	x
Neubauer Patrik	9	25	8	1	-	-	5	-	-	1	-	7	3	-	5	320	360	320	19	2	1	955	4	-	-	1	-	5,1	-	4	2	000	3,38
Novák Josef	12	25	9	4	-	1	7	12	1	-	-	14	4	-	7	360	640	579	8	5	2	867	6	1	4	-	1	24,0	29	13	4	1000	1,50
Pirgl Michal	1	2	-	-	-	-	1	1	1	-	-	-	1	-	1	000	000	500	7	1	-	1000	-	-	-	-	-	-	-	-	-	x	x
Soukup Michal	14	49	26	10	2	3	4	11	2	-	-	36	10	-	24	531	1000	629	24	1	2	926	-	-	-	-	-	-	-	-	-	x	x
Šťastný David	2	-	-	-	-	-	-	-	-	-	-	-	-	-	-	x	x	x	1	2	1	750	2	-	-	-	-	5,1	4	5	4	x	6,75
Tyc Matěj	9	20	3	1	-	-	6	7	-	-	-	4	5	-	9	150	200	370	2	-	-	1000	-	-	-	-	-	-	-	-	-	x	x
Vlach Vojtěch	11	19	4	-	-	-	2	2	-	-	-	4	-	-	6	211	211	286	15	9	4	857	5	-	2	1	-	26,1	13	17	11	667	3,76
Vojta Petr	3	7	2	1	-	-	2	2	-	-	-	2	-	1	-	286	429	444	9	4	3	813	-	-	-	-	-	-	-	-	-	x	x
Zhupanin Vasil	14	51	22	6	2	3	11	7	2	-	-	12	10	-	22	431	804	517	8	12	6	769	5	1	3	1	1	-	34	21	11	750	4,43

První liga 2018 - základní část
League One 2018 - regular season



hráč player	pálka / batting																pole / fielding						nadhoz / pitching										
	G	AB	H	2B	3B	HR	SO	BB	HP	SH	SF	RBI	SB	CS	R	BA	SLG	OBP	PO	A	E	FA	G	CG	W	L	SV	IP	SO	R-	ER	W/L	ERA
Klasik FM	16	570	208	36	15	13	73	85	23	5	6	168	35	3	198	365	549	462	336	117	50	901	16	2	9	7	5	115,2	98	124	73	563	5,68
Adamus Jindřich	12	36	12	4	3	-	6	2	1	-	-	10	4	-	12	333	611	385	22	2	-	1000	5	1	3	1	-	15,0	18	18	10	750	6,00
Baker Michal	15	13	5	1	-	-	2	7	-	-	-	3	-	-	4	385	462	600	10	12	1	957	6	1	3	2	-	33,0	20	31	19	600	5,18
Drong Eduard	6	15	4	1	-	-	2	2	2	-	-	5	-	-	7	267	333	421	29	-	2	935	-	-	-	-	-	-	-	-	-	x	x
Drong Martin	10	34	13	2	2	2	2	2	1	-	1	8	3	-	15	382	735	421	14	17	-	1000	3	-	-	-	1	13,0	11	14	6	x	4,15
Geryk Jakub	7	18	7	1	-	-	2	2	-	-	-	3	2	-	4	389	444	450	1	4	2	714	-	-	-	-	-	-	-	-	-	x	x
Gurník Ondřej	15	48	15	2	1	1	10	8	3	-	-	12	1	-	18	313	458	441	33	12	8	849	-	-	-	-	-	-	-	-	-	x	x
Hanko Patrik	9	29	12	1	1	-	-	4	-	-	1	6	3	-	13	414	517	471	10	-	-	1000	-	-	-	-	-	-	-	-	-	x	x
Hon Ondřej	15	54	24	3	2	3	2	4	1	-	1	21	1	-	11	444	741	483	68	4	5	935	3	-	1	1	-	6,0	5	2	2	500	3,00
Kaplan Jakub	9	36	13	3	-	4	5	6	2	-	1	19	2	1	16	361	778	467	15	15	7	811	3	-	-	-	-	2,1	5	-	-	x	0,00
Kociňák Pavel	8	9	3	1	-	-	3	2	1	1	-	1	-	-	4	333	444	500	21	2	-	1000	2	-	-	1	-	8,2	2	9	7	000	7,27
Kokošínský Martin	1	-	-	-	-	-	-	-	-	-	-	-	-	-	-	x	x	x	-	-	-	x	1	-	-	-	-	1,1	1	6	6	x	40,50
Koláček David	9	26	10	2	-	-	6	7	1	1	-	5	4	-	7	385	462	529	28	4	3	914	1	-	1	-	-	3,0	4	-	-	1000	0,00
Konečný Marek	1	2	-	-	-	-	1	-	-	-	-	-	-	-	-	000	000	000	-	-	-	x	-	-	-	-	-	-	-	-	-	x	x
Kozel Matyáš	12	54	20	3	2	1	4	4	-	-	-	24	3	-	16	370	556	414	13	18	8	795	1	-	-	-	1	1,0	-	-	-	x	0,00
Lapiš Daniel	11	28	11	2	-	-	8	3	1	-	-	11	-	-	5	393	464	469	6	2	1	889	-	-	-	-	-	-	-	-	-	x	x
Míček Tomáš	15	58	22	4	1	2	3	13	7	1	1	13	7	2	27	379	586	532	28	7	5	875	-	-	-	-	-	-	-	-	-	x	x
Pavelka Kamil	6	5	2	-	-	-	2	-	2	-	-	-	1	-	4	400	400	571	13	2	2	882	4	-	-	-	2	4,1	4	5	-	x	0,00
Pospíchal Jiří	7	25	8	-	1	-	4	3	-	1	1	1	-	-	7	320	400	379	4	-	-	1000	-	-	-	-	-	-	-	-	-	x	x
Šimiček Jiří	5	2	1	-	1	-	-	2	-	1	-	2	1	-	4	500	1500	750	3	1	-	1000	6	-	1	1	-	9,1	10	16	6	500	5,79
Šmoldas Martin	1	3	-	-	-	-	-	-	-	-	-	1	1	-	-	000	000	000	3	-	1	750	-	-	-	-	-	-	-	-	-	x	x
Urban Šimon	13	44	18	5	1	-	5	3	-	-	-	18	1	-	12	409	568	447	7	6	-	1000	5	-	-	1	-	14,0	12	18	13	000	8,36
Vítek Adam	12	31	8	1	-	-	6	11	1	-	-	5	1	-	12	258	290	465	8	9	5	773	-	-	-	-	-	-	-	-	-	x	x
Volný Tomáš	3	-	-	-	-	-	-	-	-	-	-	-	-	-	-	x	x	x	-	-	-	x	3	-	-	-	1	4,2	6	5	4	x	7,71

První liga 2018 - základní část
League One 2018 - regular season

hráč player	pálka / batting															pole / fielding						nadhoz / pitching												
	G	AB	H	2B	3B	HR	SO	BB	HP	SH	SF	RBI	SB	CS	R	BA	SLG	OBP	PO	A	E	FA	G	CG	W	L	SV	IP	SO	R-	ER	W/L	ERA	
Hroch z.s.	14	526	155	24	2	6	93	113	19	2	4	112	51	7	170	295	382	434	357	124	33	936	14	3	8	6	1	115,0	93	114	79	571	6,18	
Boček Tomáš	4	13	3	-	-	-	1	2	-	-	-	1	-	-	4	231	231	333	2	-	-	1000	1	-	1	-	-	2,1	6	4	2	1000	7,71	
Boda Michal	6	20	8	-	-	-	1	4	1	1	-	3	4	1	8	400	400	520	8	18	2	929	-	-	-	-	-	-	-	-	-	x	x	
Čudovský Jakub	2	4	1	-	-	-	1	-	-	-	-	1	-	-	-	250	250	250	3	3	1	857	-	-	-	-	-	-	-	-	-	x	x	
Daněk Martin	8	13	2	-	-	-	6	7	-	-	-	1	-	-	6	154	154	450	3	-	-	1000	-	-	-	-	-	-	-	-	-	x	x	
Felkl Jan	6	25	11	3	-	-	5	1	-	-	-	8	2	-	7	440	560	462	11	12	3	885	-	-	-	-	-	-	-	-	-	x	x	
Hřib Jan	8	4	1	-	-	-	1	4	-	-	-	1	1	-	3	250	250	625	-	6	-	1000	7	-	1	3	1	20,2	17	30	24	250	10,45	
Janderka Petr	13	36	13	2	-	1	8	10	3	-	1	9	9	1	19	361	500	520	14	1	-	1000	3	-	1	-	-	6,0	3	1	1	1000	1,50	
Jelínek Filip	13	33	4	1	-	-	4	4	-	-	-	4	2	1	6	121	152	216	13	14	3	900	5	1	2	-	-	26,2	20	20	17	1000	5,74	
Kalandra Ondřej	1	4	1	-	-	-	1	1	-	-	-	-	-	-	1	250	250	400	1	2	1	750	-	-	-	-	-	-	-	-	-	x	x	
Kocour Dan	13	49	17	2	-	2	10	9	1	-	1	18	5	1	12	347	510	450	23	2	-	1000	-	-	-	-	-	-	-	-	-	x	x	
Macík Lukáš	2	3	1	1	-	-	-	-	-	-	-	1	-	-	-	333	667	333	-	-	-	x	-	-	-	-	-	-	-	-	-	x	x	
Mánek Jakub	4	14	7	3	-	-	5	1	1	-	-	5	4	-	4	500	714	563	9	-	-	1000	-	-	-	-	-	-	-	-	-	x	x	
Mc Dowall Kenneth	2	4	2	-	-	1	-	5	-	-	-	3	-	-	3	500	1250	778	-	-	-	x	-	-	-	-	-	-	-	-	-	-	x	x
Neufinger Lukáš	13	49	12	1	-	-	11	4	-	-	-	4	7	-	7	245	265	302	49	11	4	938	-	-	-	-	-	-	-	-	-	-	x	x
Novotný Lukaš	5	16	2	-	-	-	4	2	1	-	-	-	-	-	2	125	125	263	2	6	1	889	-	-	-	-	-	-	-	-	-	-	x	x
Novotný Petr	8	11	3	-	-	-	1	3	2	-	-	1	-	-	6	273	273	500	6	3	2	818	5	-	1	2	-	33,0	21	25	19	333	5,18	
Opršal Martin	13	41	10	1	-	-	6	11	5	-	-	5	3	-	21	244	268	456	22	9	5	861	-	-	-	-	-	-	-	-	-	x	x	
Rovný Jan	5	17	3	-	-	-	4	6	-	-	-	1	-	-	5	176	176	391	23	9	2	941	-	-	-	-	-	-	-	-	-	-	x	x
Rutta Jindřich	1	-	-	-	-	-	-	-	-	-	-	-	-	-	-	x	x	x	1	-	-	1000	-	-	-	-	-	-	-	-	-	-	x	x
Samek Matěj	1	3	-	-	-	-	-	1	-	-	-	-	-	-	-	000	000	250	2	-	1	667	-	-	-	-	-	-	-	-	-	-	x	x
Sedláček Tomáš	3	8	4	1	-	-	-	3	1	-	-	5	2	-	6	500	625	667	6	3	1	900	-	-	-	-	-	-	-	-	-	-	x	x
Sobotka Martin	10	37	15	2	1	-	3	3	1	-	-	8	6	2	14	405	514	463	25	3	-	1000	-	-	-	-	-	-	-	-	-	-	x	x
Svída Viktor	5	15	2	1	-	-	4	1	-	-	1	3	1	-	2	133	200	176	2	-	-	1000	-	-	-	-	-	-	-	-	-	-	x	x
Svoboda Tomáš	6	21	6	-	-	-	1	7	-	-	-	8	-	-	5	286	286	464	10	11	1	955	-	-	-	-	-	-	-	-	-	-	x	x
Šenk Filip	6	17	4	-	-	-	4	5	-	-	-	1	1	-	6	235	235	409	5	2	2	778	1	-	-	-	-	2,0	-	-	-	-	x	0,00
Štoudek Daniel	2	4	2	-	-	-	1	2	1	1	-	3	2	-	2	500	500	714	1	3	2	667	-	-	-	-	-	-	-	-	-	-	x	x
Vašourek František	16	59	19	6	-	2	10	17	1	-	1	18	2	1	19	322	525	474	114	5	2	983	-	-	-	-	-	-	-	-	-	-	x	x
Whitehead Raymond	1	4	1	-	1	-	1	-	-	-	-	-	-	-	-	250	750	250	1	-	-	1000	-	-	-	-	-	-	-	-	-	-	x	x
Žondra Tomáš	6	2	1	-	-	-	-	-	1	-	-	-	-	-	2	500	500	667	1	1	-	1000	5	2	2	1	-	24,1	26	34	16	667	5,92	

První liga 2018 - základní část
League One 2018 - regular season



hráč player	pálka / batting																			pole / fielding						nadhoz / pitching									
	G	AB	H	2B	3B	HR	SO	BB	HP	SH	SF	RBI	SB	CS	R	BA	SLG	OBP	PO	A	E	FA	G	CG	W	L	SV	IP	SO	R-	ER	W/L	ERA		
Pelikans Bučovice	13	444	125	29	4	3	76	19	84	3	1	90	46	7	120	282	385	416	290	106	42	904	13	3	2	11	2	102,2	71	228	174	154	15,25		
Čiháček Matouš	14	34	6	2	-	-	5	-	7	-	-	2	2	-	10	176	235	317	7	1	2	800	-	-	-	-	-	-	-	-	-	x	x		
Foitzl Jiří	2	5	3	-	-	-	1	-	-	-	-	1	1	-	3	600	600	600	3	-	-	1000	1	-	-	-	-	4,0	1	9	6	x	13,50		
Foitzl Jiří	14	45	9	1	-	-	4	-	11	-	-	7	1	-	5	200	222	357	12	-	3	800	1	-	-	1	-	3,0	1	15	13	000	39,00		
Georgiev Georgi	1	4	3	-	-	-	2	-	-	-	-	1	-	-	2	750	750	750	-	-	-	x	-	-	-	-	-	-	-	-	-	x	x		
Hernandez Alberto	4	3	-	-	-	-	1	-	1	-	-	1	-	-	2	000	000	250	3	2	2	714	4	2	1	1	1	19,2	21	30	28	500	12,81		
Chavez Jose	1	4	2	-	-	-	-	-	-	-	-	1	-	-	-	500	500	500	-	-	-	x	-	-	-	-	-	-	-	-	-	x	x		
Janík Karel	9	14	4	3	-	-	5	-	2	-	1	6	4	-	7	286	500	353	13	26	4	907	4	1	-	4	-	25,1	16	43	25	000	8,88		
Kotrba Tomáš	15	42	16	5	-	-	11	4	5	1	-	9	8	1	13	381	500	490	50	13	2	969	-	-	-	-	-	-	-	-	-	x	x		
Koudelka Vojtěch	11	24	9	1	-	-	5	2	5	-	-	2	2	1	8	375	417	516	12	4	2	889	4	-	-	1	-	9,1	6	26	20	000	19,29		
Krejčí Libor	15	39	12	1	1	1	10	1	12	-	-	12	3	2	11	308	462	481	23	3	3	897	7	-	-	-	-	14,1	12	38	33	x	20,72		
Kubečka Adam	13	46	11	2	-	-	6	1	8	1	-	2	10	-	13	239	283	364	41	8	8	860	-	-	-	-	-	-	-	-	-	x	x		
Kubečka Jakub	2	-	-	-	-	-	-	-	-	-	-	-	-	-	-	x	x	x	7	-	-	1000	1	-	-	1	-	2,1	1	5	3	000	11,57		
Mikulášek Jan	3	4	2	-	-	-	1	-	2	-	-	1	-	-	1	500	500	667	-	-	-	x	-	-	-	-	-	-	-	-	-	x	x		
Posolda Marek	12	41	11	3	1	-	1	1	6	1	-	7	-	-	8	268	390	375	45	6	3	944	-	-	-	-	-	-	-	-	-	x	x		
Posolda Michal	11	24	8	1	-	-	3	3	5	-	-	5	2	-	5	333	375	500	18	7	3	893	-	-	-	-	-	-	-	-	-	x	x		
Sedláček Milan	2	3	1	-	-	-	-	-	1	-	-	-	-	-	-	333	333	500	-	-	-	x	-	-	-	-	-	-	-	-	-	x	x		
Svoboda Jakub	6	12	1	-	-	-	3	1	3	-	-	1	1	1	1	083	083	313	2	6	-	1000	2	-	-	-	-	2,2	2	3	3	x	10,13		
Šmehlík Daniel	10	24	3	1	-	-	2	2	7	-	-	2	1	-	2	125	167	364	15	2	-	1000	-	-	-	-	-	-	-	-	-	x	x		
Vykoukal Lubomír	9	3	-	-	-	-	4	-	1	-	-	1	-	-	2	000	000	250	2	-	1	667	-	-	-	-	-	-	-	-	-	x	x		
Vykoukal Ondřej	14	35	7	2	2	-	7	3	4	-	-	8	3	1	11	200	371	333	25	16	5	891	5	-	-	2	1	13,1	9	28	23	000	15,53		
Vykoukal Tomáš	12	38	17	7	-	2	5	1	4	-	-	21	8	1	16	447	789	512	12	12	4	857	5	-	1	1	-	8,2	2	31	20	500	20,77		

První liga 2018 - základní část
League One 2018 - regular season



hráč player	pálka / batting																pole / fielding						nadhoz / pitching										
	G	AB	H	2B	3B	HR	SO	BB	HP	SH	SF	RBI	SB	CS	R	BA	SLG	OBP	PO	A	E	FA	G	CG	W	L	SV	IP	SO	R-	ER	W/L	ERA
Wolfs Domažlice	16	475	147	36	2	14	90	84	21	-	2	113	85	9	153	309	482	433	308	62	32	920	16	2	6	10	1	100,2	72	203	160	375	14,30
Černý Lukáš	2	2	-	-	-	-	2	-	-	-	-	-	-	-	-	000	000	000	1	1	-	1000	2	-	-	2	-	7,0	7	21	17	000	21,86
Černý Matěj	7	8	1	-	-	-	3	6	-	-	-	1	3	-	3	125	125	500	7	2	-	1000	3	-	-	-	-	2,1	2	8	7	x	27,00
Černý Michal	11	34	9	4	-	-	9	8	2	-	-	2	5	2	12	265	382	432	16	5	3	875	4	1	1	3	-	23,0	16	38	29	250	11,35
Dluhoš Vladimír	10	37	10	3	-	-	4	4	-	-	-	13	10	-	5	270	351	341	27	4	1	969	-	-	-	-	-	-	-	-	-	x	x
Hartl Tomáš	2	5	-	-	-	-	2	-	-	-	-	-	-	-	-	000	000	000	-	-	-	x	-	-	-	-	-	-	-	-	-	x	x
Hubený Vladimír	10	13	1	-	-	-	5	4	1	-	-	-	3	1	4	077	077	333	6	-	1	857	5	-	-	1	-	8,1	2	27	18	000	19,44
Mach Václav	14	41	7	2	-	-	4	6	2	-	-	8	4	2	7	171	220	306	10	1	1	917	-	-	-	-	-	-	-	-	-	x	x
McCarthy Gregory	5	6	2	-	-	-	-	-	-	-	-	1	-	-	1	333	333	333	4	-	-	1000	3	-	-	-	1	4,1	8	-	-	x	0,00
Novák Ondřej	16	52	23	7	-	5	11	14	6	-	1	20	24	1	32	442	865	589	45	18	5	926	-	-	-	-	-	-	-	-	-	x	x
Novák Pavel	16	60	20	7	-	1	7	9	2	-	-	10	14	1	25	333	500	437	46	3	1	980	-	-	-	-	-	-	-	-	-	x	x
Pekovič Michal	16	60	23	3	-	3	9	5	1	-	1	15	5	-	13	383	583	433	48	2	1	980	-	-	-	-	-	-	-	-	-	x	x
Schneider Josef	12	30	7	-	-	-	8	2	1	-	-	8	1	-	7	233	233	303	28	3	1	969	-	-	-	-	-	-	-	-	-	x	x
Skala Petr	12	31	5	2	-	-	5	7	4	-	-	4	2	-	15	161	226	381	22	6	3	903	4	-	2	2	-	16,0	6	41	31	500	17,44
Strádal Tomáš	1	2	-	-	-	-	2	1	-	-	-	-	-	-	1	000	000	333	3	-	-	1000	-	-	-	-	-	-	-	-	-	x	x
Trávníček Lukáš	15	48	17	3	-	-	10	7	-	-	-	5	10	1	14	354	417	436	27	7	11	756	2	1	-	1	-	9,2	7	23	22	000	20,48
Weber Martin	13	46	22	5	2	5	9	11	2	-	-	26	4	1	14	478	1000	593	18	10	4	875	7	-	3	1	-	30,0	24	45	36	750	10,80

První liga 2018 - základní část
League One 2018 - regular season



hráč player	pálka / batting														pole / fielding						nadhaz / pitching													
	G	AB	H	2B	3B	HR	SO	BB	HP	SH	SF	RBI	SB	CS	R	BA	SLG	OBP	PO	A	E	FA	G	CG	W	L	SV	IP	SO	R-	ER	W/L	ERA	
Orli Choceň	15	485	126	28	4	1	128	86	21	2	84	2	71	15	117	260	340	345	338	117	74	860	15	4	5	10	2	115,0	60	226	145	333	11,35	
Andrle Michal	6	20	4	-	-	-	6	-	-	-	-	-	1	-	7	200	200	200	-	1	-	1000	-	-	-	-	-	-	-	-	-	-	x	x
Andrle Tomáš	10	43	12	1	-	-	8	3	1	-	9	-	3	2	10	279	302	286	2	-	-	1000	-	-	-	-	-	-	-	-	-	-	x	x
Bříza Lukáš	15	28	5	1	1	-	11	8	-	-	4	-	8	1	6	179	286	325	3	-	-	1000	9	2	2	2	1	41,2	22	77	39	500	8,42	
Cífra Marek	10	31	13	5	-	1	2	8	2	-	12	1	8	1	14	419	677	434	16	9	1	962	4	-	-	2	-	13,0	13	33	25	000	17,31	
Dobruský Martin	12	41	12	6	1	-	8	7	4	-	13	-	11	3	12	293	488	354	10	4	1	933	1	-	-	-	-	3,2	-	4	1	x	2,45	
Ell Jan	8	19	4	-	-	-	5	2	-	-	-	-	3	1	5	211	211	286	15	25	3	930	-	-	-	-	-	-	-	-	-	-	x	x
Hubálek Ondřej	11	19	4	-	1	-	7	7	-	-	4	-	6	1	4	211	316	367	62	1	5	926	4	2	-	3	-	18,0	4	48	36	000	18,00	
Chocholouš Petr	4	8	-	-	-	-	2	2	1	-	1	-	2	-	3	000	000	250	14	7	2	913	2	1	1	1	-	10,2	6	22	18	500	15,19	
Chocholouš Vít	4	3	1	-	-	-	-	2	-	-	-	-	-	-	-	333	333	600	17	11	3	903	3	1	2	1	-	19,0	9	25	12	667	5,68	
Christoph Lukáš	3	10	2	-	-	-	2	1	1	-	1	1	-	-	2	200	200	308	7	1	1	889	-	-	-	-	-	-	-	-	-	-	x	x
Jeřábek Jaroslav	7	14	2	-	-	-	7	5	-	-	1	-	1	-	3	143	143	350	36	19	7	887	-	-	-	-	-	-	-	-	-	-	x	x
Kadoch David	10	33	9	-	-	-	6	4	1	-	1	-	4	2	9	273	273	359	34	2	5	878	-	-	-	-	-	-	-	-	-	-	x	x
Kadrmaz Ondřej	10	30	12	4	-	-	8	6	4	-	13	-	6	-	9	400	533	415	33	-	6	846	1	-	-	-	-	-	-	3	1	x	x	
Kudláček Filip	6	25	8	3	-	-	7	3	-	-	3	-	1	-	6	320	440	355	4	1	1	833	2	-	-	-	1	6,0	6	3	3	x	4,50	
Novotný Petr	8	26	9	2	1	-	2	2	1	-	8	-	1	1	5	346	500	324	8	9	4	810	-	-	-	-	-	-	-	-	-	-	x	x
Pilc Jan	1	-	-	-	-	-	-	-	-	-	-	-	-	-	-	x	x	x	19	11	8	789	-	-	-	-	-	-	-	-	-	-	x	x
Potštejnský Tomáš	7	21	1	1	-	-	12	2	-	-	3	-	-	-	1	048	095	115	21	3	7	774	-	-	-	-	-	-	-	-	-	-	x	x
Shejbal Petr	11	30	5	2	-	-	11	9	-	-	6	-	3	2	2	167	233	311	26	6	10	762	-	-	-	-	-	-	-	-	-	-	x	x
Šrut Martin	12	32	11	2	-	-	8	7	4	1	2	-	9	-	7	344	406	489	5	-	2	714	-	-	-	-	-	-	-	-	-	-	x	x
Žufánek Jakub	11	31	6	1	-	-	6	6	2	1	3	-	4	1	8	194	226	333	6	7	8	619	1	-	-	1	-	3,0	-	11	10	000	30,00	
Žufánek Jan	7	21	6	-	-	-	10	2	-	-	-	-	-	-	4	286	286	348	-	-	-	x	-	-	-	-	-	-	-	-	-	-	x	x

První liga 2018 - základní část
League One 2018 - regular season



hráč player	pálka / batting																pole / fielding				nadhoz / pitching												
	G	AB	H	2B	3B	HR	SO	BB	HP	SH	SF	RBI	SB	CS	R	BA	SLG	OBP	PO	A	E	FA	G	CG	W	L	SV	IP	SO	R-	ER	W/L	ERA
Sharks Sp, Poříčí	15	357	93	16	1	-	130	55	6	-	-	29	61	8	47	261	311	368	232	67	69	813	15	1	-	15	-	88,2	62	320	241	000	24,46
Čížek Jiří	14	24	5	-	-	-	10	6	1	-	-	4	-	-	2	208	208	387	13	2	6	714	-	-	-	-	-	-	-	-	-	x	x
Fridrich Václav	5	11	5	1	-	-	2	3	-	-	-	3	-	-	1	455	545	571	12	1	4	765	-	-	-	-	-	-	-	-	-	x	x
Kališ Radim	3	7	2	1	-	-	1	2	-	-	-	-	1	-	1	286	429	444	12	1	-	1000	-	-	-	-	-	-	-	-	-	x	x
Kotek Jiří	2	7	3	-	-	-	-	-	-	-	-	-	1	-	-	429	429	429	-	1	-	1000	1	-	-	-	-	7,0	6	7	5	x	6,43
Kučera Michal	3	7	1	-	-	-	2	-	-	-	-	-	1	-	-	143	143	143	5	-	3	625	-	-	-	-	-	-	-	-	-	x	x
Kuryluk Petr	10	25	5	-	-	-	14	2	-	-	-	1	3	-	2	200	200	259	5	-	1	833	-	-	-	-	-	-	-	-	-	x	x
Linda Jiří	11	21	-	-	-	-	17	5	-	-	-	1	-	-	2	000	000	192	4	1	8	385	-	-	-	-	-	-	-	-	-	x	x
Linhart Jakub	11	21	6	-	-	-	10	5	1	-	-	1	3	1	2	286	286	444	19	7	5	839	-	-	-	-	-	-	-	-	-	x	x
Linhart Matej	4	14	2	1	-	-	10	-	1	-	-	-	3	-	2	143	214	200	9	-	1	900	-	-	-	-	-	-	-	-	-	x	x
Mikuš Lubomír	1	1	1	-	-	-	-	1	-	-	-	-	-	-	-	1000	1000	1000	2	-	-	1000	-	-	-	-	-	-	-	-	-	x	x
Novák Kryštof	3	6	2	-	1	-	1	-	2	-	-	1	-	-	-	333	667	500	3	3	-	1000	1	-	-	1	-	2,0	3	6	6	000	27,00
Paur Lukáš	1	3	-	-	-	-	1	-	-	-	-	-	-	-	-	000	000	000	-	-	-	x	-	-	-	-	-	-	-	-	-	x	x
Pech Adolf	8	16	2	-	-	-	9	4	-	-	-	-	1	-	-	125	125	300	8	-	-	1000	-	-	-	-	-	-	-	-	-	x	x
Prantner Radek	16	45	19	2	-	-	7	3	1	-	-	6	20	2	8	422	467	469	49	11	8	882	7	-	-	3	-	15,1	11	71	54	000	31,70
Šašek Petr	13	27	7	2	-	-	12	12	-	-	-	4	10	-	7	259	333	487	15	10	9	735	2	-	-	-	-	2,1	1	8	7	x	27,00
Šrámek Alexander	16	50	12	2	-	-	18	-	-	-	-	5	3	1	4	240	280	240	36	7	8	843	8	1	-	4	-	28,1	19	97	55	000	17,47
Šrámek Pavel	14	37	10	3	-	-	11	6	-	-	-	1	9	4	9	270	351	372	23	9	5	865	6	-	-	2	-	15,2	12	52	41	000	23,55
Šrámek Pavel st	4	5	-	-	-	-	2	2	-	-	-	-	-	-	-	000	000	286	5	1	1	857	-	-	-	-	-	-	-	-	-	x	x
Vybíral Michal	13	30	11	4	-	-	3	4	-	-	-	2	6	-	7	367	500	441	12	13	10	714	6	-	-	4	-	13,0	8	69	66	000	45,69
Zíka Pavel	1	-	-	-	-	-	-	-	-	-	-	-	-	-	-	x	x	x	-	-	-	x	1	-	-	1	-	5,0	2	10	7	000	12,60

První liga 2018 - play-off
 League One 2018 - play-off

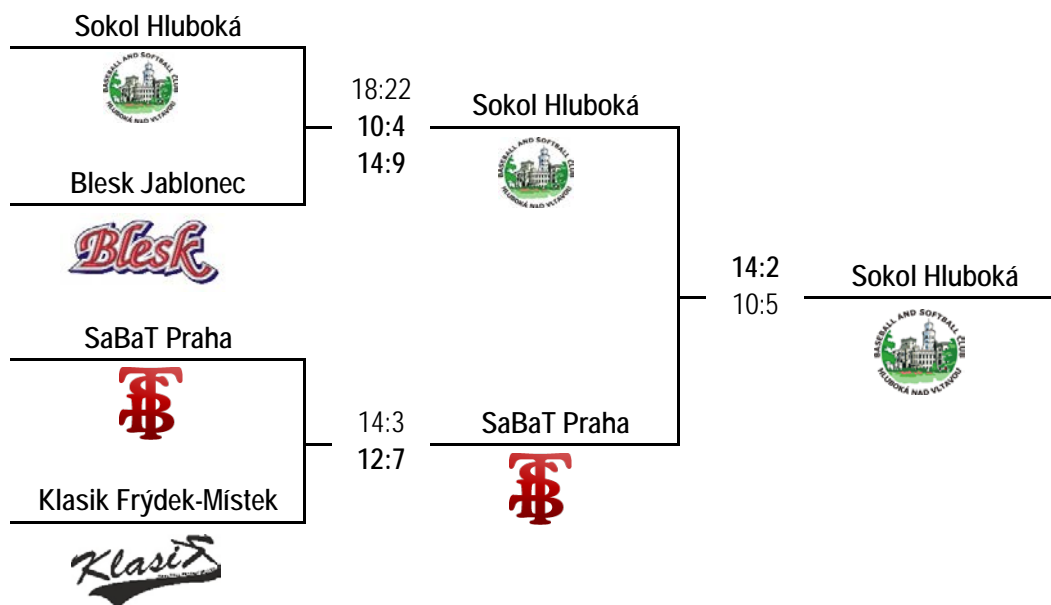

tučně jsou uvedena domácí utkání horního týmu
home games of the upper team are bold



První liga 2018 - play-off League One 2018 - play-off

hráč player	pálka / batting															pole / fielding					nadhaz / pitching												
	G	AB	H	2B	3B	HR	SO	BB	HP	SH	SF	RBI	SB	CS	R	BA	SLG	OBP	PO	A	E	FA	G	CG	W	L	SV	IP	SO	R-	ER	W/L	ERA
Sokol Hluboká	5	202	71	13	2	2	66	20	40	3	-	2	49	13	2	351	465	500	125	57	10	948	5	3	4	1	-	42,0	33	42	34	800	7,29
Dvořák Matěj	5	20	7	4	1	-	10	4	7	-	-	1	6	2	-	350	650	581	46	2	1	980	1	-	-	-	-	1,0	2	4	2	x	18,00
Hejný Stanislav	4	15	6	-	-	-	3	1	5	-	-	-	4	-	-	400	400	571	4	18	2	917	-	-	-	-	-	-	-	-	-	x	x
Herbster Quentin	5	22	12	-	1	-	14	-	6	-	-	-	6	1	-	545	636	643	1	-	1	500	-	-	-	-	-	-	-	-	-	x	x
Hošna Filip	3	16	5	1	-	-	6	1	1	-	-	1	2	1	-	313	375	389	5	9	-	1000	-	-	-	-	-	-	-	-	-	x	x
Líkař Jan	5	26	10	1	-	1	3	4	2	-	-	-	8	-	-	385	538	500	9	-	-	1000	-	-	-	-	-	-	-	-	-	x	x
Lukáš David	2	-	-	-	-	-	-	-	-	-	-	-	-	-	-	x	x	x	1	5	-	1000	2	1	2	-	-	15,0	7	11	10	1000	6,00
Marek Michal	1	3	-	-	-	-	1	-	-	-	-	-	-	-	-	000	000	000	2	-	1	667	-	-	-	-	-	-	-	-	-	x	x
Miranda Kamil	4	20	8	4	-	-	7	2	2	-	-	-	11	1	-	400	600	500	3	11	1	933	-	-	-	-	-	-	-	-	-	x	x
Mšek Jiří	1	3	-	-	-	-	-	-	2	-	-	-	-	-	-	000	000	400	-	-	-	x	-	-	-	-	-	-	-	-	-	x	x
Neubauer Patrik	1	4	-	-	-	-	2	2	1	1	-	-	-	-	-	000	000	429	1	-	-	1000	1	-	-	-	-	0,2	2	3	3	x	40,50
Novák Josef	4	7	1	-	-	-	1	-	1	-	-	-	1	-	-	143	143	250	1	1	-	1000	2	1	1	-	-	10,0	10	5	4	1000	3,60
Soukup Michal	5	21	7	2	-	1	8	2	5	2	-	-	6	2	-	333	571	500	14	1	-	1000	-	-	-	-	-	-	-	-	-	x	x
Šťastný David	1	-	-	-	-	-	-	-	-	-	-	-	-	-	-	x	x	x	-	1	-	1000	1	1	1	-	-	9,0	8	4	3	1000	3,00
Vlach Matěj	5	22	9	1	-	-	5	2	4	-	-	-	3	1	-	409	455	536	35	4	1	975	-	-	-	-	-	-	-	-	-	x	x
Vlach Vojtěch	2	4	-	-	-	-	1	1	-	-	-	-	1	-	-	000	000	200	-	-	-	x	1	-	-	1	-	3,1	-	11	8	000	21,60
Zhupanin Vasil	4	19	6	-	-	-	5	1	4	-	-	-	1	5	2	316	316	458	3	5	3	727	1	-	-	-	-	3,0	4	4	4	x	12,00

První liga 2018 - play-off
League One 2018 - play-off



hráč player	pálka / batting																pole / fielding				nadhoz / pitching												
	G	AB	H	2B	3B	HR	SO	BB	HP	SH	SF	RBI	SB	CS	R	BA	SLG	OBP	PO	A	E	FA	G	CG	W	L	SV	IP	SO	R-	ER	W/L	ERA
SaBaT Praha	4	129	38	14	1	-	16	24	2	1	3	25	5	2	33	295	419	405	99	39	16	896	4	-	2	2	1	32,0	27	33	19	500	5,34
Babor Martin	3	5	1	-	-	-	-	1	-	-	-	-	-	-	2	200	200	333	1	3	1	800	-	-	-	-	-	-	-	-	-	x	x
Bílek Tomáš	4	15	3	3	-	-	-	3	-	-	-	4	1	-	4	200	400	333	20	6	2	929	-	-	-	-	-	-	-	-	-	x	x
Dupal Kryštof	2	10	2	1	-	-	3	-	-	-	-	1	-	-	2	200	300	200	3	6	-	1000	1	-	-	-	1	2,0	2	-	-	x	0,00
Dupal Štěpán	2	-	-	-	-	-	-	-	-	-	1	1	-	-	-	x	x	000	-	1	-	1000	1	-	1	-	-	4,0	6	-	-	1000	0,00
Hanuš Mikuláš	2	4	3	1	-	-	-	3	1	-	1	4	-	-	5	750	1000	778	3	5	2	800	-	-	-	-	-	-	-	-	-	x	x
Hasal Kryštof	3	5	-	-	-	-	1	-	-	-	-	-	-	-	-	000	000	000	13	-	2	867	1	-	-	-	-	1,0	-	4	1	x	9,00
Hejtmánek Matěj	3	7	2	-	1	-	-	1	-	-	-	2	-	-	1	286	571	375	5	4	-	1000	2	-	-	1	-	8,1	3	8	6	000	6,48
Helus Vít	3	9	2	1	-	-	2	1	1	-	-	1	-	1	1	222	333	364	12	2	1	933	-	-	-	-	-	-	-	-	-	x	x
Hrdlička Ondřej	2	5	-	-	-	-	2	-	-	-	-	-	-	-	-	000	000	000	3	2	1	833	-	-	-	-	-	-	-	-	-	x	x
Kavan Kryštof	1	-	-	-	-	-	-	1	-	-	-	-	-	-	1	x	x	1000	-	-	-	x	1	-	-	-	-	2,0	2	7	4	x	18,00
Křepinský Vít	4	14	3	-	-	-	-	1	-	-	1	2	-	-	2	214	214	250	2	2	-	1000	2	-	1	1	-	10,0	8	10	4	500	3,60
Petřina Jaroslav	3	10	5	2	-	-	-	5	-	-	-	2	3	-	5	500	700	667	3	2	2	714	1	-	-	-	-	4,1	5	4	4	x	8,31
Procházka Matouš	2	3	-	-	-	-	1	-	-	-	-	-	-	-	-	000	000	000	2	1	3	500	1	-	-	-	-	0,1	1	-	-	x	0,00
Riegger Daniel	1	4	2	1	-	-	-	-	-	-	-	-	-	-	1	500	750	500	-	3	-	1000	-	-	-	-	-	-	-	-	-	x	x
Škvařil Jan	2	5	1	-	-	-	-	1	-	-	-	-	-	-	1	200	200	333	9	-	1	900	-	-	-	-	-	-	-	-	-	x	x
Šonský Evžen	1	5	2	1	-	-	-	-	-	-	-	3	-	-	3	400	600	400	5	1	-	1000	-	-	-	-	-	-	-	-	-	x	x
Tůma Jan	4	14	7	3	-	-	1	5	-	-	-	-	1	-	4	500	714	632	9	1	-	1000	-	-	-	-	-	-	-	-	-	x	x
Veleta Štěpán	1	3	-	-	-	-	2	1	-	1	-	-	-	-	1	000	000	250	5	-	-	1000	-	-	-	-	-	-	-	-	-	x	x
Zatloukal Aleš	3	11	5	1	-	-	4	1	-	-	-	5	-	1	-	455	545	500	4	-	1	800	-	-	-	-	-	-	-	-	-	x	x



První liga 2018 - play-off
League One 2018 - play-off

hráč player	pálka / batting															pole / fielding				nadhaz / pitching														
	G	AB	H	2B	3B	HR	SO	BB	HP	SH	SF	RBI	SB	CS	R	BA	SLG	OBP	PO	A	E	FA	G	CG	W	L	SV	IP	SO	R-	ER	W/L	ERA	
Blesk Jablonec	3	106	32	4	1	-	24	18	14	1	3	24	23	2	35	302	358	454	74	27	18	849	3	1	1	2	-	25,0	7	42	27	333	9,72	
Fous Matyáš	3	15	5	-	-	-	5	2	-	-	-	3	1	-	4	333	333	412	13	-	2	867	-	-	-	-	-	-	-	-	-	-	x	x
Hikl Jiří	2	-	-	-	-	-	-	-	-	-	-	-	-	-	-	x	x	x	1	-	-	1000	-	-	-	-	-	-	-	-	-	-	x	x
Kachurka Aliaksei	3	13	4	1	-	-	3	1	-	-	1	3	2	-	3	308	385	333	10	-	1	909	-	-	-	-	-	-	-	-	-	-	x	x
Kavan Petr	1	-	-	-	-	-	-	-	-	-	-	-	-	-	-	x	x	x	-	-	-	x	1	-	-	-	-	6,0	1	11	4	x	6,00	
Machačka Zdeněk	3	12	6	-	-	-	3	1	2	-	-	3	3	-	6	500	500	600	5	3	4	667	-	-	-	-	-	-	-	-	-	-	x	x
Mencl Pavel	1	3	-	-	-	-	1	1	-	-	-	-	-	-	-	000	000	250	4	-	-	1000	-	-	-	-	-	-	-	-	-	-	x	x
Riedl Karel	3	11	2	-	-	-	2	3	-	1	1	3	1	-	3	182	182	333	13	7	-	1000	2	-	-	1	-	6,1	-	18	13	000	18,47	
Roubíček Lukáš	3	6	2	-	-	-	1	4	1	-	-	-	3	-	4	333	333	636	7	3	1	909	1	1	-	1	-	8,0	3	10	8	000	9,00	
Ševčík Tomáš	1	1	-	-	-	-	-	-	-	-	-	-	-	-	-	000	000	000	-	1	-	1000	-	-	-	-	-	-	-	-	-	-	x	x
Uhnavý Jakub	3	13	3	-	-	-	3	-	1	-	-	1	4	1	3	231	231	286	5	-	-	1000	-	-	-	-	-	-	-	-	-	-	x	x
Výbora Jan	3	9	2	-	-	-	-	2	4	-	1	2	4	1	3	222	222	500	2	7	6	600	2	-	1	-	-	4,2	3	1	1	1000	1,93	
Výbora Jonáš	3	11	4	3	-	-	2	1	6	-	-	3	3	-	6	364	636	611	7	6	1	929	-	-	-	-	-	-	-	-	-	-	x	x
Zikmunda David	3	12	4	-	1	-	4	3	-	-	-	6	2	-	3	333	500	467	7	-	3	700	-	-	-	-	-	-	-	-	-	-	x	x
Zikmunda Tomáš	1	-	-	-	-	-	-	-	-	-	-	-	-	-	-	x	x	x	-	-	-	x	1	-	-	-	-	-	-	2	1	x	x	

První liga 2018 - play-off
League One 2018 - play-off



hráč player	pálka / batting																pole / fielding				nadhaz / pitching													
	G	AB	H	2B	3B	HR	SO	BB	HP	SH	SF	RBI	SB	CS	R	BA	SLG	OBP	PO	A	E	FA	G	CG	W	L	SV	IP	SO	R-	ER	W/L	ERA	
Klasik FM	2	63	14	1	-	-	14	8	1	1	-	6	1	1	10	222	238	319	48	24	7	911	2	-	-	2	-	16,0	7	26	19	000	10,69	
Baker Michal	2	4	-	-	-	-	1	1	-	-	-	1	-	-	1	000	000	200	2	4	3	667	1	-	-	1	-	5,0	-	3	2	000	3,60	
Drong Martin	2	7	2	-	-	-	-	2	-	-	-	2	-	-	1	286	286	444	5	6	-	1000	1	-	-	-	-	3,0	2	1	-	x	0,00	
Geryk Jakub	1	2	-	-	-	-	1	-	1	-	-	-	-	-	-	000	000	333	-	-	-	x	-	-	-	-	-	-	-	-	-	x	x	
Gurník Ondřej	2	7	3	-	-	-	2	2	-	-	-	-	-	-	3	429	429	556	2	6	1	889	-	-	-	-	-	-	-	-	-	-	x	x
Hanko Patrik	2	4	-	-	-	-	1	2	-	1	-	-	-	-	1	000	000	333	4	-	-	1000	-	-	-	-	-	-	-	-	-	-	x	x
Hon Ondřej	2	8	2	-	-	-	1	-	-	-	-	-	-	-	1	250	250	250	19	-	1	950	-	-	-	-	-	-	-	-	-	-	x	x
Kolářek David	2	1	-	-	-	-	-	-	-	-	-	-	-	-	-	000	000	000	1	1	-	1000	1	-	-	-	-	4,0	4	4	3	x	6,75	
Kozel Matyáš	2	8	1	-	-	-	3	-	-	-	-	-	-	1	-	125	125	125	3	5	1	889	-	-	-	-	-	-	-	-	-	-	x	x
Lapiš Daniel	2	4	-	-	-	-	3	-	-	-	-	-	-	-	-	000	000	000	1	-	-	1000	-	-	-	-	-	-	-	-	-	-	x	x
Míček Tomáš	2	8	3	1	-	-	-	-	-	-	-	3	1	-	1	375	500	375	9	1	1	909	-	-	-	-	-	-	-	-	-	-	x	x
Šimiček Jiří	1	-	-	-	-	-	-	-	-	-	-	-	-	-	-	x	x	x	-	-	-	x	1	-	-	1	-	1,0	-	7	6	000	54,00	
Urban Šimon	2	8	3	-	-	-	2	1	-	-	-	-	-	-	2	375	375	444	2	1	-	1000	1	-	-	-	-	2,1	1	9	8	x	30,86	
Vítek Adam	1	2	-	-	-	-	-	-	-	-	-	-	-	-	-	000	000	000	-	-	-	x	-	-	-	-	-	-	-	-	-	-	x	x
Volný Tomáš	1	-	-	-	-	-	-	-	-	-	-	-	-	-	-	x	x	x	-	-	-	x	1	-	-	-	-	0,2	-	2	-	-	x	0,00

Extraliga 2018 - nadstavba o udržení
Extra League 2018 - post season

1.	Nuclears Třebíč	
2.	Olympia Blansko	
3.	Technika Brno	
4.	Skokani Olomouc	
5.	SaBaT Praha	
6.	Sokol Hluboká	
7.	Blesk Jablonec	
8.	Klasik Frýdek-Místek	

Extraliga 2018 - nadstavba o udržení
Extra League 2018 - post season

	Nuclears	Olympia	Technika	Skokani	SaBaT	Hluboká	Blesk	Klasik	G	W	L	PCT	R	R-
Nuclears Třebíč		3 - 1 0 - 1	4 - 6 11 - 0	13 - 0 8 - 9	14 - 8 3 - 1	8 - 4 14 - 4	13 - 2 14 - 2	12 - 1 13 - 0	14	11	3	786	130	39
Olympia Blansko	1 - 3 1 - 0		6 - 1 6 - 5	4 - 3 0 - 1	4 - 5 7 - 4	6 - 7 8 - 3	3 - 0 15 - 4	19 - 0 7 - 5	14	10	4	714	87	41
Technika Brno	6 - 4 0 - 11	1 - 6 5 - 6		1 - 5 7 - 1	8 - 3 4 - 1	18 - 3 10 - 8	18 - 3 8 - 2	4 - 6 16 - 2	14	9	5	643	106	61
Skokani Olomouc	0 - 13 9 - 8	3 - 4 1 - 0	5 - 1 1 - 7		9 - 3 12 - 10	8 - 6 6 - 3	16 - 17 12 - 22	15 - 9 12 - 1	14	9	5	643	109	104
SaBaT Praha	8 - 14 1 - 3	5 - 4 4 - 7	3 - 8 1 - 4	3 - 9 10 - 12		1 - 18 6 - 3	5 - 3 15 - 9	17 - 13 13 - 2	14	6	8	429	92	109
Sokol Hluboká	4 - 8 4 - 14	7 - 6 3 - 8	3 - 18 8 - 10	6 - 8 3 - 6	18 - 1 3 - 6		18 - 17 3 - 4	8 - 11 17 - 11	14	4	10	286	105	128
Blesk Jablonec	2 - 13 2 - 14	0 - 3 4 - 15	3 - 18 2 - 8	17 - 16 22 - 12	3 - 5 9 - 15	17 - 18 4 - 3		22 - 7 11 - 12	14	4	10	286	118	159
Klasik FM	1 - 12 0 - 13	0 - 19 5 - 7	6 - 4 2 - 16	9 - 15 1 - 12	13 - 17 2 - 13	11 - 8 11 - 17	7 - 22 12 - 11		14	3	11	214	80	186



Extraliga 2018 - nadstavba o udržení
Extra League 2018 - post season

hráč player	pálka / batting														pole / fielding						nadhoz / pitching																
	G	AB	H	2B	3B	HR	SO	BB	HP	SH	SF	RBI	SB	CS	R	BA	SLG	OBP	PO	A	E	FA	G	CG	W	L	SV	IP	SO	R-	ER	W/L	ERA				
Třebíč Nuclears	14	447	142	23	8	7	71	73	11	5	3	108	27	2	131	318	452	423	282	125	31	929	14	6	11	3	2	107,2	115	39	22	786	1,84				
Brandon Valentin	8	-	-	-	-	-	-	-	-	-	-	-	-	-	-	x	x	x	1	8	1	900	8	1	2	1	2	31,0	33	20	10	667	2,90				
Davis Derron	14	45	15	2	1	1	2	18	3	-	-	16	10	1	18	333	489	545	12	27	3	929	-	-	-	-	-	-	-	-	-	x	x				
Doležal Dominik	14	57	17	5	-	-	9	3	2	1	-	10	1	-	20	298	386	355	22	1	1	958	-	-	-	-	-	-	-	-	-	x	x				
Dvořák Roman	1	1	-	-	-	-	-	1	-	-	-	-	1	-	1	000	000	500	-	-	-	x	-	-	-	-	-	-	-	-	-	x	x				
Green Reece	7	2	-	-	-	-	1	-	-	-	-	-	-	-	-	000	000	000	3	9	-	1000	7	2	4	1	-	41,1	39	11	5	800	1,09				
Hlouch Lukáš	9	18	4	-	-	1	2	2	-	1	-	4	-	-	3	222	389	300	15	11	4	867	4	3	3	-	-	19,0	27	2	1	1000	0,47				
Krejčířik Marek	1	1	-	-	-	-	1	2	-	-	-	-	-	-	-	000	000	667	1	2	-	1000	-	-	-	-	-	-	-	-	-	x	x				
Křivánek Michal	1	1	-	-	-	-	1	1	-	-	-	-	-	-	-	000	000	500	2	-	1	667	-	-	-	-	-	-	-	-	-	-	x	x			
Křivánek Miroslav	8	30	8	1	-	-	6	4	-	1	-	3	1	-	7	267	300	353	11	19	3	909	-	-	-	-	-	-	-	-	-	-	x	x			
Kutílek Zdeněk	8	28	14	2	-	2	6	5	-	-	-	10	2	-	9	500	786	576	7	2	-	1000	-	-	-	-	-	-	-	-	-	-	x	x			
Libiak Jozef	4	9	2	-	-	-	3	2	1	-	1	2	1	-	4	222	222	385	-	-	-	x	-	-	-	-	-	-	-	-	-	-	x	x			
Mazura Martin	3	4	1	-	-	-	1	1	-	-	-	1	-	-	1	250	250	400	1	-	-	1000	-	-	-	-	-	-	-	-	-	-	-	x	x		
Novotný Jiří	8	26	7	-	-	-	2	4	-	-	-	5	3	-	8	269	269	367	8	2	1	909	-	-	-	-	-	-	-	-	-	-	-	x	x		
Pejchal Kamil	14	47	18	1	1	-	8	8	-	-	-	12	3	-	12	383	447	473	37	14	5	911	-	-	-	-	-	-	-	-	-	-	-	x	x		
Pruša Michal	5	1	-	-	-	-	1	-	-	-	-	-	-	-	-	000	000	000	1	2	-	1000	5	-	2	1	-	16,1	16	6	6	667	3,31				
Sklenář David	9	29	7	3	1	-	7	7	1	1	-	1	1	1	8	241	414	405	12	2	3	824	-	-	-	-	-	-	-	-	-	-	-	x	x		
Touron Luis	14	57	28	7	5	3	6	2	3	-	-	28	-	-	21	491	947	532	59	6	1	985	-	-	-	-	-	-	-	-	-	-	-	x	x		
Urbánek Jan	11	32	7	-	-	-	3	2	1	-	2	8	2	-	6	219	219	270	66	3	1	986	-	-	-	-	-	-	-	-	-	-	-	-	x	x	
Vašek Jakub	11	28	5	2	-	-	10	7	-	-	-	3	-	-	6	179	250	343	11	1	2	857	-	-	-	-	-	-	-	-	-	-	-	-	x	x	
Vávra Robin	9	31	9	-	-	-	2	4	-	1	-	5	2	-	7	290	290	371	13	16	5	853	-	-	-	-	-	-	-	-	-	-	-	-	-	x	x

Extraliga 2018 - nadstavba o udržení
Extra League 2018 - post season



hráč player	pálka / batting																pole / fielding						nadhoz / pitching												
	G	AB	H	2B	3B	HR	SO	BB	HP	SH	SF	RBI	SB	CS	R	BA	SLG	OBP	PO	A	E	FA	G	CG	W	L	SV	IP	SO	R-	ER	W/L	ERA		
Olympia Blansko	14	455	122	21	2	-	89	52	15	7	2	77	48	7	87	268	323	361	343	113	33	933	14	9	10	4	-	117,2	98	40	30	714	2,29		
Blažek Aleš	13	35	12	4	-	-	7	3	-	1	-	6	3	1	8	343	457	395	24	3	1	964	4	1	1	2	-	14,2	9	4	3	333	1,84		
Farkaš David	12	29	7	2	-	-	3	2	1	1	1	7	3	1	5	241	310	303	13	9	4	846	4	2	3	-	-	27,0	23	11	9	1000	3,00		
Havlíček Štěpán	11	21	6	-	-	-	2	-	-	1	-	4	-	-	3	286	286	286	4	5	2	818	6	4	4	1	-	45,2	38	17	11	800	2,17		
Hrubý Jiří	3	9	4	1	-	-	1	-	2	-	-	2	1	-	4	444	556	545	1	8	2	818	1	-	-	-	-	1,2	1	-	-	x	0,00		
Jelínek Tomáš	14	44	13	1	1	-	16	12	2	-	-	7	10	1	11	295	364	466	25	2	2	931	1	-	-	-	-	5,2	2	5	4	x	6,35		
Jelínek Zdeněk	1	2	-	-	-	-	-	1	-	-	-	-	-	-	1	000	000	333	-	-	-	x	-	-	-	-	-	-	-	-	-	-	x	x	
Kabeš Ladislav	13	43	7	3	-	-	15	7	-	1	-	3	1	-	7	163	233	280	50	6	5	918	-	-	-	-	-	-	-	-	-	-	x	x	
Kohoutek Michal	13	42	8	1	-	-	12	3	1	2	1	8	5	-	8	190	214	255	27	24	4	927	-	-	-	-	-	-	-	-	-	-	x	x	
Konvalinka Miroslav	1	4	-	-	-	-	-	-	-	-	-	1	-	-	-	000	000	000	-	-	-	x	-	-	-	-	-	-	-	-	-	-	x	x	
Kříž Jaroslav	5	13	5	-	-	-	2	-	-	-	-	4	-	-	2	385	385	385	6	1	-	1000	-	-	-	-	-	-	-	-	-	-	x	x	
Kučera Ivo	1	4	-	-	-	-	1	-	-	-	-	-	-	-	-	000	000	000	-	-	-	x	-	-	-	-	-	-	-	-	-	-	x	x	
Lošťák David	14	57	18	5	-	-	9	4	2	-	-	12	8	-	6	316	404	381	19	14	4	892	-	-	-	-	-	-	-	-	-	-	x	x	
Němec Jaroslav	14	53	11	-	-	-	2	6	2	-	-	6	4	-	13	208	208	311	44	-	-	1000	-	-	-	-	-	-	-	-	-	-	-	x	x
Šebela Ondřej	11	33	8	1	-	-	8	2	2	1	-	5	5	3	5	242	273	324	11	16	5	844	-	-	-	-	-	-	-	-	-	-	x	x	
Šustal Jiří	4	13	4	1	-	-	3	1	-	-	-	-	1	-	5	308	385	357	30	4	1	971	-	-	-	-	-	-	-	-	-	-	x	x	
Ue Natsuhiko	14	49	19	2	1	-	6	11	3	-	-	12	7	1	8	388	469	524	86	19	3	972	-	-	-	-	-	-	-	-	-	-	x	x	
Yasuda Akimasa	6	4	-	-	-	-	2	-	-	-	-	-	-	-	1	000	000	000	3	2	-	1000	4	2	2	1	-	23,0	25	3	3	667	1,17		

Extraliga 2018 - nadstavba o udržení
Extra League 2018 - post season



hráč <i>player</i>	pálka / <i>batting</i>																pole / <i>fielding</i>						nadhoz / <i>pitching</i>												
	G	AB	H	2B	3B	HR	SO	BB	HP	SH	SF	RBI	SB	CS	R	BA	SLG	OBP	PO	A	E	FA	G	CG	W	L	SV	IP	K	R-	ER	W/L	ERA		
Technika Brno	13	477	141	23	2	14	82	82	10	5	5	101	30	1	106	296	440	406	350	104	18	962	13	7	9	4	1	116,0	153	61	40	692	3,10		
Bláha Vojtěch	4	11	4	2	-	-	2	-	-	-	-	1	-	-	-	364	545	364	6	1	1	875	3	-	-	-	-	9,0	5	3	2	x	2,00		
Brabec Matěj	12	42	10	1	-	-	6	8	-	1	-	3	8	-	13	238	262	360	12	12	3	889	2	-	-	-	-	2,0	4	4	3	x	13,50		
Burian Radek	4	4	-	-	-	-	3	1	-	-	-	-	1	-	-	000	000	200	9	5	-	1000	3	-	-	2	-	10,0	8	10	3	000	2,70		
Georgiev Georgi	5	16	6	2	-	1	-	3	-	-	-	3	3	-	2	375	688	474	41	6	-	1000	-	-	-	-	-	-	-	-	-	x	x		
Goleš Petr	4	7	1	-	-	-	1	2	1	1	-	1	1	-	1	143	143	400	-	1	-	1000	-	-	-	-	-	-	-	-	-	-	x	x	
Gottschall Mário	10	40	13	-	1	1	6	3	1	-	-	6	1	-	8	325	450	386	43	8	-	1000	1	-	-	-	-	2,0	-	-	-	-	x	0,00	
Janík Karel	1	-	-	-	-	-	-	-	-	-	-	-	-	-	-	x	x	x	-	1	-	1000	1	-	-	-	-	3,0	3	2	1	x	3,00		
Johnson Julian	8	26	9	2	1	3	6	10	1	-	2	14	-	-	7	346	846	513	11	2	2	867	-	-	-	-	-	-	-	-	-	-	x	x	
Just Daniel	2	6	-	-	-	-	-	1	-	-	-	-	-	-	-	000	000	143	-	-	-	x	-	-	-	-	-	-	-	-	-	-	x	x	
Kelar Sebastian	4	8	3	-	-	-	3	1	-	-	1	1	1	-	4	375	375	400	3	7	1	909	1	-	-	-	-	1,0	-	-	-	-	x	0,00	
Klimeš Michal	12	53	22	3	-	3	5	7	-	-	-	14	3	-	13	415	642	483	30	7	5	881	4	1	1	-	-	7,0	6	5	5	1000	6,43		
Kočí Michal	9	28	8	2	-	-	4	5	1	1	-	3	-	-	5	286	357	412	49	1	-	1000	2	1	2	-	-	14,0	7	8	3	1000	1,93		
Pomazal Vojtěch	14	56	13	2	-	-	7	7	1	1	-	6	4	1	9	232	268	328	7	27	2	944	2	-	-	-	-	2,0	-	2	2	x	9,00		
Regner Martin	2	-	-	-	-	-	-	-	-	-	-	-	-	-	-	x	x	x	-	1	-	1000	2	-	-	-	-	5,0	6	2	2	x	3,60		
Rivera Joe	11	43	17	4	-	3	6	6	1	-	-	14	1	-	12	395	698	480	2	4	1	857	8	5	6	1	1	53,0	106	20	16	857	2,72		
Sázavský Oliver	9	26	6	-	-	-	8	4	1	1	-	6	4	-	7	231	231	355	14	2	-	1000	1	-	-	-	-	1,0	2	1	1	x	9,00		
Sázavský Richard	10	33	10	2	-	1	1	7	1	-	1	11	2	-	9	303	455	429	27	2	-	1000	-	-	-	-	-	-	-	-	-	-	x	x	
Střítecký Martin	6	22	4	-	-	-	4	4	-	-	-	-	-	-	4	182	182	308	56	10	1	985	1	-	-	1	-	7,0	6	4	2	000	2,57		
Svoboda Jakub	7	13	-	-	-	-	8	5	1	-	-	-	-	-	3	000	000	316	4	2	-	1000	-	-	-	-	-	-	-	-	-	-	x	x	
Škaroupka Martin	9	25	3	-	-	-	10	5	-	-	1	4	1	-	2	120	120	258	31	1	2	941	-	-	-	-	-	-	-	-	-	-	x	x	
Zelinka Martin	5	18	12	3	-	2	2	3	1	-	-	14	-	-	7	667	1167	727	5	4	-	1000	-	-	-	-	-	-	-	-	-	-	-	x	x

Extraliga 2018 - nadstavba o udržení
Extra League 2018 - post season



hráč player	pálka / batting																pole / fielding						nadhoz / pitching											
	G	AB	H	2B	3B	HR	SO	BB	HP	SH	SF	RBI	SB	CS	R	BA	SLG	OBP	PO	A	E	FA	G	CG	W	L	SV	IP	K	R-	ER	W/L	ERA	
Skokani Olomouc	14	479	129	19	13	7	87	74	18	6	7	87	34	1	108	269	407	382	359	148	34	937	14	6	9	5	1	119,2	93	102	74	643	5,57	
Adamus Jindřich	12	56	17	1	2	1	7	4	1	-	1	10	4	-	17	304	446	355	21	29	4	926	-	-	-	-	-	-	-	-	-	-	x	x
Antoš Ondřej	8	22	6	1	1	-	6	8	3	-	1	1	1	-	7	273	409	500	7	-	1	875	-	-	-	-	-	-	-	-	-	-	x	x
Borůvka Jakub	9	31	6	-	-	-	7	4	-	2	-	5	3	-	4	194	194	286	51	4	2	965	-	-	-	-	-	-	-	-	-	-	x	x
Daněk Filip	8	23	2	-	-	-	6	7	2	-	-	4	4	-	3	087	087	344	30	2	1	970	-	-	-	-	-	-	-	-	-	-	x	x
Fusek Aleš	1	1	-	-	-	-	1	-	-	-	-	-	-	-	-	000	000	000	-	-	-	x	-	-	-	-	-	-	-	-	-	-	x	x
Hlavička Marek	2	5	-	-	-	-	3	2	-	-	-	-	1	-	1	000	000	286	7	-	-	1000	-	-	-	-	-	-	-	-	-	-	x	x
Chapman Joel	12	39	13	1	-	1	4	-	1	1	-	7	-	-	6	333	436	350	32	14	2	958	5	3	3	2	-	37,0	27	33	23	600	5,59	
Kohout Michal	5	6	1	-	-	-	2	-	-	-	-	1	-	-	-	167	167	167	1	3	-	1000	4	-	1	1	-	18,1	9	17	15	500	7,36	
Košata Ondřej	6	9	1	1	-	-	3	3	-	-	-	-	3	-	4	111	222	333	3	1	-	1000	1	-	-	-	-	3,1	3	4	4	x	10,80	
Kovařík Jiří	8	27	5	-	-	-	2	9	1	-	-	2	1	1	6	185	185	405	7	5	2	857	-	-	-	-	-	-	-	-	-	-	x	x
Lázníček Matěj	12	52	20	3	5	3	8	2	1	-	2	16	2	-	13	385	808	404	17	-	-	1000	1	-	1	-	-	6,0	7	-	-	1000	0,00	
Mik Petr	10	12	3	-	-	-	4	4	1	-	-	1	1	-	1	250	250	471	3	5	-	1000	5	-	-	1	-	12,2	4	24	14	000	9,95	
Poledna Martin	10	30	11	2	1	-	6	1	1	1	-	11	1	-	4	367	500	406	17	2	1	950	-	-	-	-	-	-	-	-	-	-	x	x
Prokeš Michal	2	-	-	-	-	-	-	-	-	-	-	-	-	-	-	x	x	x	-	2	-	1000	2	-	-	-	1	6,0	6	5	4	x	6,00	
Schwarz Ondřej	9	39	15	5	1	-	4	2	-	-	1	12	2	-	7	385	564	405	4	16	6	769	-	-	-	-	-	-	-	-	-	-	x	x
Schwarz Pavel	7	12	1	-	-	-	6	-	-	1	-	1	-	-	-	083	083	083	29	1	-	1000	4	-	1	-	-	6,1	3	2	2	1000	2,84	
Sova Marek	9	28	6	-	1	1	5	8	6	1	2	8	3	-	14	214	393	455	92	4	2	980	-	-	-	-	-	-	-	-	-	-	x	x
Šimek Jiří	1	-	-	-	-	-	-	-	-	-	-	-	-	-	-	x	x	x	-	-	-	x	1	-	-	1	-	2,0	1	10	6	000	27,00	
Van der Linden Nathan	10	47	15	4	2	1	4	1	1	-	-	7	4	-	10	319	553	347	18	23	8	837	3	3	3	-	-	28,0	33	7	6	1000	1,93	
Zdražil Martin	14	40	7	1	-	-	9	19	-	-	-	1	4	-	11	175	200	441	20	37	5	919	-	-	-	-	-	-	-	-	-	-	x	x

Extraliga 2018 - nadstavba o udržení
Extra League 2018 - post season



hráč player	pálka / batting															pole / fielding						nadhoz / pitching											
	G	AB	H	2B	3B	HR	SO	BB	HP	SH	SF	RBI	SB	CS	R	BA	SLG	OBP	PO	A	E	FA	G	CG	W	L	SV	IP	SO	R-	ER	W/L	ERA
SaBaT Praha	14	500	144	26	4	8	85	49	16	4	3	74	26	9	92	288	404	368	359	146	38	930	14	1	6	8	1	120,0	83	109	83	429	6,23
Babor Martin	1	2	1	-	-	-	-	1	-	1	-	-	-	-	500	500	667	1	3	-	1000	-	-	-	-	-	-	-	-	-	-	x	x
Bílek Tomáš	11	38	8	-	-	-	3	9	1	1	-	1	1	1	8	211	211	375	69	12	4	953	-	-	-	-	-	-	-	-	-	x	x
Dupal Kryštof	14	32	7	3	-	1	10	4	2	-	1	3	2	-	5	219	406	333	24	23	4	922	6	-	2	2	-	23,1	16	24	17	500	6,56
Dupal Štěpán	7	7	2	-	-	-	2	1	-	-	-	-	-	-	286	286	375	2	-	-	1000	5	-	-	2	1	16,0	24	7	5	000	2,81	
Hanuš Mikuláš	5	16	6	1	-	-	6	2	2	-	1	2	-	-	3	375	438	476	4	11	5	750	-	-	-	-	-	-	-	-	-	x	x
Hasal Kryštof	8	15	-	-	-	-	6	1	-	-	-	-	-	-	1	000	000	063	23	3	2	929	4	-	-	-	-	8,0	8	16	11	x	12,38
Hejtmánek Matěj	10	22	9	3	-	-	3	4	-	-	-	8	1	1	4	409	545	500	14	1	-	1000	5	-	1	-	-	20,1	8	18	17	1000	7,52
Helus Vít	5	16	1	-	-	-	3	1	-	-	-	1	1	1	2	063	063	118	22	1	1	958	-	-	-	-	-	-	-	-	-	x	x
Křepinský Vít	14	46	14	5	1	2	8	3	1	-	1	13	2	-	6	304	587	353	6	30	3	923	7	1	3	4	-	43,0	23	26	14	429	2,93
Kříž Michal	4	17	4	1	-	-	4	2	-	-	-	3	4	-	3	235	294	316	37	-	-	1000	-	-	-	-	-	-	-	-	-	x	x
Němeček Jakub	10	33	8	-	-	-	10	2	2	-	-	4	2	1	7	242	242	324	55	1	2	966	-	-	-	-	-	-	-	-	-	x	x
Peřina Šimon	7	28	8	1	1	-	1	2	1	-	-	6	2	-	5	286	393	355	5	2	-	1000	-	-	-	-	-	-	-	-	-	x	x
Petřina Jaroslav	12	44	15	1	-	-	1	7	2	-	-	2	5	1	10	341	364	453	16	25	7	854	2	-	-	-	-	5,0	2	6	6	x	10,80
Riegger Daniel	14	60	23	8	2	3	2	5	1	-	-	16	1	-	20	383	733	439	17	16	6	846	-	-	-	-	-	-	-	-	-	x	x
Škvařil Jan	14	40	10	-	-	-	7	-	2	1	-	6	2	3	2	250	250	286	22	4	2	929	4	-	-	-	-	4,1	2	12	13	x	27,00
Šonský Evžen	3	5	2	1	-	-	2	-	-	-	-	1	-	-	1	400	600	400	3	3	1	857	-	-	-	-	-	-	-	-	-	x	x
Tůma David	2	4	-	-	-	-	-	-	-	-	-	-	-	-	-	000	000	000	1	-	-	1000	-	-	-	-	-	-	-	-	-	x	x
Tůma Jan	9	33	14	2	-	2	5	4	1	-	-	7	-	1	6	424	667	500	23	6	1	967	-	-	-	-	-	-	-	-	-	x	x
Tvrz Daniel	1	3	-	-	-	-	3	-	-	-	-	-	-	-	-	000	000	000	-	3	-	1000	-	-	-	-	-	-	-	-	-	x	x
Veleta Štěpán	2	6	3	-	-	-	2	-	-	1	-	-	1	-	3	500	500	500	5	1	-	1000	-	-	-	-	-	-	-	-	-	x	x
Zatloukal Aleš	8	33	9	-	-	-	7	1	1	-	-	1	2	-	6	273	273	314	10	1	-	1000	-	-	-	-	-	-	-	-	-	x	x



Extraliga 2018 - nadstavba o udržení Extra League 2018 - post season

hráč player	pálka / batting															pole / fielding						nadhoz / pitching												
	G	AB	H	2B	3B	HR	SO	BB	HP	SH	SF	RBI	SB	CS	R	BA	SLG	OBP	PO	A	E	FA	G	CG	W	L	SV	IP	SO	R-	ER	WL	ERA	
Sokol Hluboká	14	514	152	29	2	6	92	52	11	2	9	92	29	8	105	296	395	367	358	140	55	901	14	1	4	10	1	115,2	65	116	78	286	6,07	
Dvořák Matěj	12	44	14	6	1	-	10	2	1	-	2	16	1	1	4	318	500	347	71	2	7	913	-	-	-	-	-	-	-	-	-	-	x	x
Hejný Stanislav	14	53	19	1	-	-	10	5	1	1	2	8	1	1	13	358	377	410	22	36	15	795	4	-	-	-	-	9,0	6	17	14	x	14,00	
Herbster Quentin	14	59	29	3	1	3	3	3	-	-	1	15	9	2	18	492	729	508	18	2	1	952	-	-	-	-	-	-	-	-	-	x	x	
Hošna Filip	12	45	12	2	-	-	6	4	5	-	1	7	7	-	13	267	311	382	21	14	6	854	-	-	-	-	-	-	-	-	-	x	x	
Klimovič Martin	1	-	-	-	-	-	-	-	-	-	-	-	-	-	-	x	x	x	1	1	-	1000	-	-	-	-	-	-	-	-	-	x	x	
Konvalinka Ondřej	1	2	-	-	-	-	-	-	-	-	-	-	-	-	-	000	000	000	-	-	-	x	-	-	-	-	-	-	-	-	-	x	x	
Kouba Václav	8	27	6	-	-	-	6	4	-	-	-	2	1	1	6	222	222	323	11	15	2	929	-	-	-	-	-	-	-	-	-	x	x	
Líkař Jan	13	48	15	2	-	1	10	6	2	-	1	11	-	-	7	313	417	404	18	3	1	955	-	-	-	-	-	-	-	-	-	x	x	
Lukáš David	1	-	-	-	-	-	-	-	-	-	-	-	-	-	-	x	x	x	-	2	-	1000	1	-	1	-	-	5,2	3	9	4	1000	6,35	
Mařík Jakub	1	1	-	-	-	-	-	-	-	-	-	-	-	-	-	000	000	000	5	-	-	1000	-	-	-	-	-	-	-	-	-	x	x	
Miranda Kamil	5	17	7	2	-	-	2	4	-	-	-	2	2	-	5	412	529	524	10	15	2	926	-	-	-	-	-	-	-	-	-	x	x	
Mlsek Jiří	10	27	10	-	-	-	3	3	-	1	-	-	1	1	8	370	370	433	37	6	1	977	-	-	-	-	-	-	-	-	-	x	x	
Neubauer Patrik	10	30	2	-	-	-	12	-	1	-	-	4	-	-	1	067	067	097	50	2	5	912	4	-	-	-	-	6,1	-	9	7	x	9,95	
Novák Josef	14	48	10	5	-	2	10	5	-	-	1	9	2	-	8	208	438	278	10	5	-	1000	5	-	1	1	-	20,1	13	14	12	500	5,31	
Soukup Michal	12	45	13	3	-	-	7	7	-	-	1	8	3	-	10	289	356	377	34	2	2	947	-	-	-	-	-	-	-	-	-	x	x	
Šťastný David	4	1	-	-	-	-	-	-	-	-	-	1	-	-	-	000	000	000	-	2	-	1000	4	1	1	2	-	21,1	14	14	5	333	2,11	
Tyc Matěj	1	2	-	-	-	-	1	-	-	-	-	-	-	-	-	000	000	000	2	-	-	1000	-	-	-	-	-	-	-	-	-	x	x	
Vlach Matěj	7	18	3	-	-	-	3	3	1	-	-	1	-	-	3	167	167	318	21	3	2	923	-	-	-	-	-	-	-	-	-	x	x	
Vlach Vojtěch	8	4	-	-	-	-	1	-	-	-	-	-	-	-	-	000	000	000	4	5	-	1000	5	-	-	4	-	31,1	12	30	20	000	5,74	
Vojta Petr	1	1	-	-	-	-	1	1	-	-	-	-	-	1	-	000	000	500	1	-	-	1000	-	-	-	-	-	-	-	-	-	x	x	
Zhupanin Vasil	14	42	12	5	-	-	7	5	-	-	-	8	2	1	9	286	405	362	22	25	11	810	7	-	1	3	1	-	17	23	16	250	6,65	



Extraliga 2018 - nadstavba o udržení
Extra League 2018 - post season

hráč player	pálka / batting															pole / fielding						nadhoz / pitching												
	G	AB	H	2B	3B	HR	SO	BB	HP	SH	SF	RBI	SB	CS	R	BA	SLG	OBP	PO	A	E	FA	G	CG	W	L	SV	IP	SO	R-	ER	W/L	ERA	
Blesk Jablonec	14	463	128	23	3	14	116	80	20	6	6	105	49	10	118	276	430	401	327	145	43	917	14	3	4	10	-	110,2	53	159	120	286	9,76	
Fous Matyáš	14	50	14	-	1	1	13	15	3	1	1	7	11	3	18	280	380	464	45	-	-	1000	-	-	-	-	-	-	-	-	-	-	x	x
Híkl Jiří	5	2	-	-	-	-	2	2	-	-	-	-	1	-	1	000	000	500	-	-	-	x	5	-	-	-	-	9,2	10	22	22	x	20,48	
Kachurka Aliaksei	13	54	13	3	-	1	18	4	1	-	-	7	9	1	9	241	352	305	53	12	3	956	-	-	-	-	-	-	-	-	-	x	x	
Kavan Petr	4	-	-	-	-	-	-	-	-	-	-	-	-	-	-	x	x	x	-	5	1	833	4	-	-	2	-	22,0	7	32	21	000	8,59	
Machačka Zdeněk	14	56	18	3	-	2	13	3	3	1	-	14	4	-	10	321	482	387	26	18	7	863	-	-	-	-	-	-	-	-	-	x	x	
Mencl Pavel	9	30	5	1	-	-	9	4	-	-	-	3	-	-	3	167	200	265	17	-	-	1000	-	-	-	-	-	-	-	-	-	x	x	
Riedl Karel	14	45	16	5	-	-	7	9	1	2	1	10	2	3	15	356	467	464	75	15	7	928	7	-	1	3	-	28,0	10	35	27	250	8,68	
Roubíček Lukáš	14	35	9	2	-	2	11	8	-	1	1	8	5	1	9	257	486	386	23	21	7	863	-	-	-	-	-	-	-	-	-	x	x	
Ševčík Tomáš	12	34	3	-	-	-	13	8	-	-	-	2	-	-	5	088	088	262	10	8	3	857	7	3	3	4	-	44,0	20	52	40	429	8,18	
Uhnavý Jakub	6	17	4	3	-	-	5	1	1	1	1	6	-	-	3	235	412	300	3	-	-	1000	-	-	-	-	-	-	-	-	-	x	x	
Výbora Jan	14	53	18	1	1	2	10	7	4	-	2	22	7	-	15	340	509	439	35	41	4	950	4	-	-	1	-	5,0	5	14	6	000	10,80	
Výbora Jonáš	12	41	20	4	-	6	6	8	7	-	-	17	6	2	19	488	1024	625	22	23	9	833	2	-	-	-	-	2,0	1	4	4	x	18,00	
Zikmunda David	8	23	5	-	1	-	5	7	-	-	-	5	1	-	5	217	304	400	10	1	1	917	-	-	-	-	-	-	-	-	-	x	x	
Zikmunda Tomáš	8	23	3	1	-	-	4	4	-	-	-	4	3	-	6	130	174	259	8	1	1	900	-	-	-	-	-	-	-	-	-	x	x	



Extraliga 2018 - nadstavba o udržení
Extra League 2018 - post season

hráč player	pálka / batting														pole / fielding						nadhoz / pitching												
	G	AB	H	2B	3B	HR	SO	BB	HP	SH	SF	RBI	SB	CS	R	BA	SLG	OBP	PO	A	E	FA	G	CG	W	L	SV	IP	SO	R-	ER	W/L	ERA
Klasik FM	14	434	127	24	2	-	80	55	15	7	5	62	18	7	80	293	357	387	308	109	46	901	14	5	3	11	-	101,1	46	141	136	214	12,08
Baker Michal	14	30	13	2	-	-	7	13	-	1	-	4	5	1	10	433	500	605	17	21	6	864	5	2	1	3	-	24,0	6	4ř	28	250	10,50
Drong Eduard	1	-	-	-	-	-	-	-	-	-	-	-	-	-	-	x	x	x	-	-	-	x	-	-	-	-	-	-	-	-	-	x	x
Drong Martin	12	45	20	6	1	-	2	3	1	-	-	10	3	1	11	444	622	490	13	28	3	932	6	2	1	3	-	38,0	23	42	25	250	5,92
Geryk Jakub	6	13	2	1	-	-	5	2	2	-	-	-	1	-	5	154	231	353	3	-	1	750	-	-	-	-	-	-	-	-	-	x	x
Gurník Ondřej	12	43	12	3	-	-	7	9	-	-	1	6	1	-	12	279	349	396	23	20	7	860	-	-	-	-	-	-	-	-	-	x	x
Hanko Patrik	7	28	10	2	-	-	3	2	-	-	2	6	-	1	5	357	429	375	24	1	-	1000	-	-	-	-	-	-	-	-	-	x	x
Hon Ondřej	12	41	12	1	-	-	9	1	-	-	-	4	1	-	7	293	317	310	30	16	6	885	3	1	-	1	-	7,1	1	29	21	000	25,77
Kociňák Pavel	6	19	4	1	-	-	2	-	2	1	-	7	-	-	-	211	263	286	27	2	1	967	1	-	-	-	-	5,1	3	9	8	x	13,50
Koláček David	10	22	1	-	-	-	6	4	-	-	-	-	-	-	-	045	045	192	13	-	-	1000	-	-	-	-	-	-	-	-	-	x	x
Kozel Matyáš	4	10	2	-	-	-	2	1	-	-	-	-	-	-	1	200	200	273	4	1	2	714	-	-	-	-	-	-	-	-	-	x	x
Lapiš Daniel	12	34	6	2	-	-	9	3	-	-	1	3	-	-	4	176	235	237	71	3	4	949	-	-	-	-	-	-	-	-	-	x	x
Míček Tomáš	9	27	5	1	1	-	6	4	2	-	1	3	-	-	3	185	296	324	20	4	5	828	-	-	-	-	-	-	-	-	-	x	x
Pavelka Kamil	9	24	6	1	-	-	6	2	4	1	-	5	2	-	6	250	292	400	17	3	3	870	2	-	-	1	-	6,2	2	12	12	000	16,20
Pospíchal Jiří	6	16	4	-	-	-	3	2	1	-	-	2	1	-	1	250	250	368	9	-	1	900	-	-	-	-	-	-	-	-	-	x	x
Šimíček Jiří	2	2	-	-	-	-	1	-	1	-	-	-	-	-	1	000	000	333	-	1	-	1000	1	-	-	1	-	1,1	1	11	11	000	74,25
Urban Šimon	12	47	16	2	-	-	7	6	1	2	-	4	4	3	8	340	383	426	13	6	1	950	5	-	1	2	-	12,0	3	27	20	333	15,00
Vítek Adam	9	29	12	2	-	-	4	3	1	1	-	6	-	1	5	414	483	485	24	2	6	813	-	-	-	-	-	-	-	-	-	x	x
Volný Tomáš	4	4	2	-	-	-	1	-	-	1	-	2	-	-	1	500	500	500	-	1	-	1000	4	-	-	-	-	6,2	7	11	11	x	14,85

Open nadstavba První ligy 2018
Open post season League One 2018

	Hroch	Pelikans	Wolfs	Orli	Sharks	G	W	L	PCT	R	R-
Hroch		7 - 5 19 - 4 9 - 7 15 - 3	4 - 7 3 - 2 2 - 0 14 - 2	24 - 9 21 - 3 14 - 3 13 - 6	17 - 3 28 - 2 19 - 0 21 - 0	16	15	1	938	230	56
Pelikans Bučovice	5 - 7 4 - 19 7 - 9 3 - 15		6 - 4 19 - 4 9 - 19 15 - 7	22 - 11 16 - 3 22 - 20 12 - 8	23 - 5 18 - 0 16 - 2 18 - 7	16	11	5	688	215	140
Wolfs Domažlice	7 - 4 2 - 3 0 - 2 2 - 14	4 - 6 4 - 19 19 - 9 7 - 15		13 - 10 17 - 2 4 - 13 16 - 6	22 - 1 17 - 0 18 - 3 32 - 3	16	9	7	563	184	110
Orli Choceň	9 - 24 3 - 21 3 - 14 6 - 13	11 - 22 3 - 16 20 - 22 8 - 12	10 - 13 2 - 17 13 - 4 6 - 16		18 - 2 19 - 12 17 - 2 16 - 3	16	5	11	313	164	213
Sharks Sp. Poříčí	3 - 17 2 - 28 0 - 19 0 - 21	5 - 23 0 - 18 2 - 16 7 - 18	1 - 22 0 - 17 3 - 18 3 - 32	2 - 18 12 - 19 2 - 17 3 - 16		16	0	16	000	45	319

tučně jsou uvedena domácí utkání
home games are bold

Extraliga U21 2018
Extra League U21 2018

1.	Draci Brno	
2.	Eagles Praha	
3.	Kotlářka Praha	
4.	Hroši Brno	
5.	Třebíč Nuclears	

Extraliga U21 2018 - základní část
Extra League U21 2018 - regular season

	Draci	Eagles	Hroši	Kotlářka	Nuclears	G	W	L	PCT	R	R-
Draci Brno		11 - 8	12 - 18	15 - 6	10 - 11	16	11	5	688	158	95
		10 - 6	14 - 4	13 - 0	20 - 3						
		8 - 2	1 - 10	8 - 2	10 - 0						
		0 - 3	9 - 8	6 - 13	11 - 1						
Eagles Praha	8 - 11		13 - 20	14 - 4	13 - 16	16	11	5	688	189	116
	6 - 10		12 - 3	20 - 10	17 - 2						
	2 - 8		9 - 3	19 - 14	8 - 7						
	3 - 0		14 - 5	16 - 3	15 - 0						
Hroši Brno	18 - 12	20 - 13		10 - 11	6 - 16	16	7	9	438	148	144
	4 - 14	3 - 12		13 - 11	9 - 4						
	10 - 1	3 - 9		2 - 5	12 - 2						
	8 - 9	5 - 14		7 - 8	18 - 3						
Kotlářka Praha	6 - 15	4 - 14	11 - 10		11 - 0	16	7	9	438	135	162
	0 - 13	10 - 20	11 - 13		20 - 8						
	2 - 8	14 - 19	5 - 2		12 - 1						
	13 - 6	3 - 16	8 - 7		5 - 10						
Nuclears Třebíč	11 - 10	16 - 13	16 - 6	0 - 11		16	4	12	250	84	197
	3 - 20	2 - 17	4 - 9	8 - 20							
	0 - 10	7 - 8	2 - 12	1 - 12							
	1 - 11	0 - 15	3 - 18	10 - 5							

tučně jsou uvedena domácí utkání
home games are bold

Extraliga U21 2018 - nadstavba
Extra League U21 2018 - post season

	Draci	Eagles	Kotlářka	Hroši	Nuclears	G	W	L	PCT	R	R-
Draci Brno		11 - 8	15 - 6	12 - 18	10 - 11	24	18	6	750	230	118
		10 - 6	13 - 0	14 - 4	20 - 3						
		8 - 2	8 - 2	1 - 10	10 - 0						
		0 - 3	6 - 13	9 - 8	11 - 1						
Eagles Praha		4 - 3	14 - 0	12 - 2	10 - 0	24	16	8	667	255	155
		1 - 11	8 - 3	9 - 0	14 - 4						
	8 - 11		14 - 4	13 - 20	13 - 16						
	6 - 10		20 - 10	12 - 3	17 - 2						
Kotlářka Praha		3 - 4	5 - 7	6 - 3	8 - 9	24	11	13	458	189	215
		11 - 1	12 - 4	12 - 6	9 - 5						
	2 - 8		19 - 14	9 - 3	8 - 7						
	3 - 0		16 - 3	14 - 5	15 - 0						
Hroši Brno		0 - 14	7 - 5	3 - 7	14 - 2	23	9	14	391	178	207
		3 - 8	4 - 12	7 - 2	16 - 3						
	18 - 12	20 - 13	10 - 11		6 - 16						
	4 - 14	3 - 12	13 - 11		9 - 4						
Nuclears Třebíč		0 - 9	6 - 12	2 - 7	10 - 7	24	6	18	250	121	278
		11 - 10	16 - 13	0 - 11	16 - 6						
		3 - 20	2 - 17	8 - 20	4 - 9						
		0 - 10	7 - 8	1 - 12	2 - 12						
Draci Brno		1 - 11	0 - 15	10 - 5	3 - 18	24	18	6	750	230	118
		0 - 10	9 - 8	2 - 14	7 - 0						
		4 - 14	5 - 9	3 - 16	7 - 10						
		8 - 9	5 - 14	7 - 8	18 - 3						

tučně jsou uvedena domácí utkání
home games are bold

Extraliga U21 2018 - play-off Extra League U21 2018 - play-off

Wild Series

Czech Series

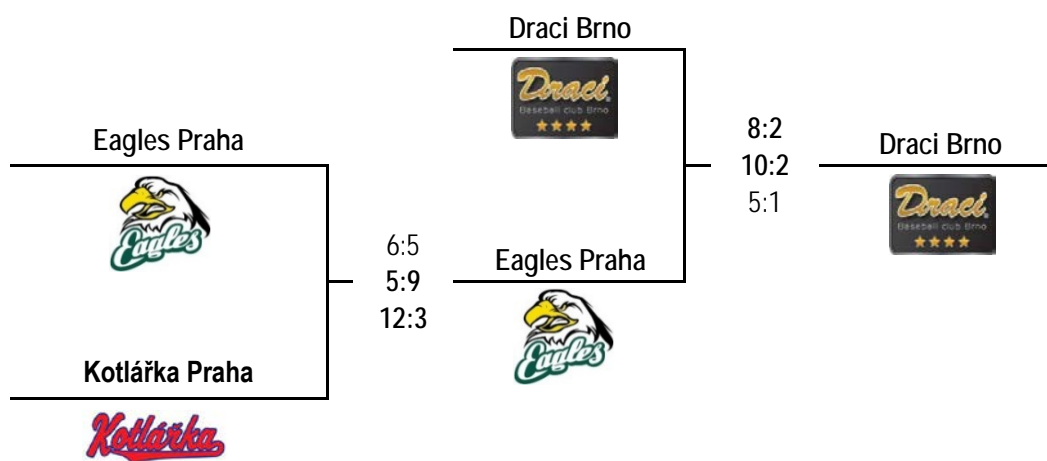

tučně jsou uvedena domácí utkání horního týmu
home games of the upper team are bold

Extraliga U21 2018 - play-off
Extra League U21 2018 - play-off



hráč player	pálka / batting																pole / fielding						nadhoz / pitching										
	G	AB	H	2B	3B	HR	SO	BB	HP	SH	SF	RBI	SB	CS	R	BA	SLG	OBP	PO	A	E	FA	G	CG	W	L	SV	IP	K	R-	ER	W/L	ERA
Draci Brno	3	105	40	9	-	-	13	7	1	5	1	17	12	4	23	381	467	421	76	29	6	946	3	-	3	-	-	27,0	31	5	2	1000	0,67
Čapka Filip	2	-	-	-	-	-	-	-	-	-	-	-	-	-	-	x	x	x	1	2	-	1000	2	-	-	-	-	7,0	8	2	1	x	1,29
Červinka Martin	3	13	4	1	-	-	2	1	-	-	-	1	3	-	2	308	385	357	1	2	-	1000	-	-	-	-	-	-	-	-	-	x	x
Furko Ondřej	3	4	2	1	-	-	2	-	-	-	-	1	1	-	1	500	750	500	6	4	-	1000	2	-	2	-	-	13,0	16	2	-	1000	0,00
Hubbard Dondrei	3	13	5	1	-	-	-	1	1	-	-	2	3	1	3	385	462	467	3	-	-	1000	-	-	-	-	-	-	-	-	-	x	x
Hudeček Lukáš	1	1	-	-	-	-	-	-	-	-	-	-	-	-	-	000	000	000	-	-	-	x	-	-	-	-	-	-	-	-	-	x	x
Chváta Zdeněk	3	11	4	-	-	-	2	-	-	1	-	1	-	-	2	364	364	364	3	4	1	875	-	-	-	-	-	-	-	-	-	x	x
Jareš Petr	1	4	1	-	-	-	-	-	-	-	-	1	1	-	2	250	250	250	5	3	2	800	-	-	-	-	-	-	-	-	-	x	x
Kalábek Martin	3	10	4	-	-	-	1	1	-	1	-	1	-	1	2	400	400	455	8	-	-	1000	-	-	-	-	-	-	-	-	-	x	x
Klanica Martin	3	10	6	2	-	-	1	-	-	2	-	3	-	1	1	600	800	600	3	8	1	917	-	-	-	-	-	-	-	-	-	x	x
Moštěk Filip	3	13	6	1	-	-	2	1	-	1	-	2	3	-	3	462	538	500	3	1	-	1000	-	-	-	-	-	-	-	-	-	x	x
Nebenfuhr Jan	3	-	-	-	-	-	-	-	-	-	-	-	-	-	-	x	x	x	-	1	-	1000	3	-	-	-	-	4,0	4	1	1	x	2,25
Řehůrek Lukáš	3	11	4	1	-	-	-	3	-	-	-	2	1	1	5	364	455	500	32	1	1	971	-	-	-	-	-	-	-	-	-	x	x
Schmied Richard	2	6	1	1	-	-	3	-	-	-	-	-	-	-	-	167	333	167	8	-	-	1000	-	-	-	-	-	-	-	-	-	x	x
Šedý Radim	3	9	3	1	-	-	-	-	-	-	1	3	-	-	2	333	444	300	3	3	1	857	-	-	-	-	-	-	-	-	-	x	x
Tauš Václav	1	-	-	-	-	-	-	-	-	-	-	-	-	-	-	x	x	x	-	-	-	x	1	-	1	-	-	3,0	3	-	-	1000	0,00



Extraliga U21 2018 - play-off
Extra League U21 2018 - play-off

hráč player	pálka / batting																pole / fielding						nadhoz / pitching													
	G	AB	H	2B	3B	HR	SO	BB	HP	SH	SF	RBI	SB	CS	R	BA	SLG	OBP	PO	A	E	FA	G	CG	W	L	SV	IP	SO	R-	ER	W/L	ERA			
Eagles Praha	5	165	34	4	1	1	41	34	2	-	1	18	22	4	22	206	261	347	129	61	16	922	5	1	1	4	-	43,0	27	35	25	200	5,23			
Aschermann Martin	4	16	6	-	-	-	2	2	-	-	-	-	3	1	3	375	375	444	12	6	2	900	-	-	-	-	-	-	-	-	-	-	x	x		
Best Michael	2	9	3	-	-	-	1	1	-	-	-	-	3	-	1	333	333	400	5	2	-	1000	-	-	-	-	-	-	-	-	-	-	x	x		
Blažek Šimon	5	15	5	2	-	1	2	3	-	-	-	5	3	2	4	333	667	444	6	8	1	933	2	1	1	1	-	16,0	11	8	8	500	4,50			
Bužga Vojtěch	3	13	3	-	-	-	3	-	-	-	-	-	4	-	2	231	231	231	6	9	2	882	-	-	-	-	-	-	-	-	-	-	x	x		
Fous Matyáš	3	11	1	-	-	-	4	-	-	-	1	2	1	-	1	091	091	083	6	-	-	1000	-	-	-	-	-	-	-	-	-	-	x	x		
Grundmann Martin	2	3	1	-	-	-	2	1	-	-	-	-	-	-	-	333	333	500	5	2	-	1000	-	-	-	-	-	-	-	-	-	-	x	x		
Hegr Ondřej	2	-	-	-	-	-	-	-	-	-	-	-	-	-	-	x	x	x	-	4	-	1000	2	-	-	-	-	4,1	1	7	3	x	6,23			
Imramovský Jan	5	18	2	-	-	-	6	5	-	-	-	-	1	-	2	111	111	304	10	8	4	818	-	-	-	-	-	-	-	-	-	-	x	x		
Konrád Jan	2	4	-	-	-	-	-	1	-	-	-	-	-	-	-	000	000	200	2	2	1	800	1	-	-	-	-	0,2	-	1	1	x	13,50			
Kvapil Ondřej	2	4	1	-	-	-	-	-	-	-	-	-	-	-	-	250	250	250	1	3	-	1000	1	-	-	1	-	6,2	-	4	1	000	1,35			
Machačka Zdeněk	3	8	1	-	-	-	1	4	1	-	-	1	1	-	1	125	125	462	9	6	-	1000	-	-	-	-	-	-	-	-	-	-	x	x		
Mareš David	2	5	1	-	-	-	3	-	-	-	-	1	-	-	-	200	200	200	2	-	-	1000	-	-	-	-	-	-	-	-	-	-	-	x	x	
Mencl Matěj	3	-	-	-	-	-	-	-	-	-	-	-	-	-	-	x	x	x	-	2	1	667	3	-	-	2	-	13,1	11	12	9	000	6,08			
Novotný Tomáš	4	12	2	1	-	-	1	5	1	-	-	2	2	-	1	167	250	444	4	1	1	833	-	-	-	-	-	-	-	-	-	-	x	x		
Petrus Tomáš	5	17	2	-	-	-	6	6	-	-	-	1	3	1	3	118	118	348	9	2	-	1000	-	-	-	-	-	-	-	-	-	-	-	x	x	
Podroužek David	1	5	2	-	1	-	2	-	-	-	-	2	-	-	-	400	800	400	11	1	2	857	-	-	-	-	-	-	-	-	-	-	-	x	x	
Riedl Karel	3	10	2	1	-	-	1	3	-	-	-	3	-	-	1	200	300	385	31	1	2	941	-	-	-	-	-	-	-	-	-	-	-	x	x	
Roubíček Lukáš	3	11	1	-	-	-	6	2	-	-	-	1	1	-	2	091	091	231	2	4	-	1000	-	-	-	-	-	-	-	-	-	-	-	-	x	x
Vojta Petr	1	4	1	-	-	-	1	1	-	-	-	-	-	-	1	250	250	400	8	-	-	1000	1	-	-	-	-	2,0	4	3	3	x	13,50			

Extraliga U21 2018 - play-off
Extra League U21 2018 - play-off

hráč player	pálka / batting																pole / fielding				nadhoz / pitching												
	G	AB	H	2B	3B	HR	SO	BB	HP	SH	SF	RBI	SB	CS	R	BA	SLG	OBP	PO	A	E	FA	G	CG	W	L	SV	IP	SO	R-	ER	W/L	ERA
Kotlářka Praha	2	69	14	3	-	-	14	6	3	-	-	6	9	1	12	203	246	295	51	11	4	939	2	-	1	1	-	17,0	10	17	16	500	8,47
Bílek Tomáš	1	4	1	1	-	-	2	-	-	-	-	1	-	-	-	250	500	250	4	1	-	1000	-	-	-	-	-	-	-	-	-	x	x
Heller Jan	2	2	1	1	-	-	-	-	1	-	-	-	-	-	1	500	1000	667	-	2	-	1000	1	-	-	-	-	4,2	4	1	1	x	1,93
Hrdlička Vít	1	-	-	-	-	-	-	-	-	-	-	-	-	-	-	x	x	x	-	-	-	x	1	-	-	-	-	2,1	2	4	4	x	15,43
Jasanský Alfréd	2	7	-	-	-	-	1	1	1	-	-	-	2	-	-	000	000	222	11	2	-	1000	-	-	-	-	-	-	-	-	-	x	x
Kolouch Pavel	2	5	1	-	-	-	-	-	-	-	-	1	1	-	1	200	200	200	1	1	-	1000	-	-	-	-	-	-	-	-	-	x	x
Komorous David	2	3	-	-	-	-	1	-	-	-	-	-	-	-	-	000	000	000	5	-	-	1000	1	-	1	-	-	4,1	1	4	3	1000	6,23
Komorous Jan	2	4	-	-	-	-	1	-	-	-	-	-	-	-	-	000	000	000	1	1	3	400	1	-	-	1	-	1,1	-	-	-	000	0,00
Kornacki Matyáš	2	7	2	-	-	-	2	2	-	-	-	-	2	-	1	286	286	444	1	2	1	750	1	-	-	-	-	1,0	-	4	4	x	36,00
Lisý Martin	2	4	1	-	-	-	3	1	-	-	-	-	-	-	2	250	250	400	2	2	-	1000	1	-	-	-	-	0,2	1	1	1	x	13,50
Lovecký Adam	2	8	2	1	-	-	1	-	1	-	-	1	1	-	3	250	375	333	2	-	-	1000	-	-	-	-	-	-	-	-	-	x	x
Němeček Jakub	2	7	3	-	-	-	1	2	-	-	-	-	3	-	3	429	429	556	12	-	-	1000	-	-	-	-	-	-	-	-	-	x	x
Novák František	2	5	1	-	-	-	1	-	-	-	-	2	-	-	-	200	200	200	2	-	-	1000	1	-	-	-	-	2,2	2	3	3	x	10,13
Novák Jakub	2	6	1	-	-	-	1	-	-	-	-	-	-	-	1	167	167	167	3	-	-	1000	-	-	-	-	-	-	-	-	-	x	x
Papp Jan	1	4	1	-	-	-	-	-	-	-	-	1	-	1	-	250	250	250	6	-	-	1000	-	-	-	-	-	-	-	-	-	x	x
Schwenk Jakub	1	3	-	-	-	-	-	-	-	-	-	-	-	-	-	000	000	000	1	-	-	1000	-	-	-	-	-	-	-	-	-	x	x

Český pohár 2018 Czech Cup 2018



Český pohár U18 2018
Czech Cup U18 2018
(Praha - Kotlářka, SaBaT)

A	Eagles	Kotlářka	Arrows	Hroši	G	W	L	PCT	R	R-
Eagles Praha		10 - 4	13 - 2	6 - 5	3	3	0	1000	29	11
Kotlářka Praha	4 - 10		7 - 6	6 - 5	3	2	1	667	17	21
Arrows Ostrava	2 - 13	6 - 7		11 - 4	3	1	2	333	19	24
Hroši Brno	5 - 6	5 - 6	4 - 11		3	0	3	000	14	23

B	Nuclears	Draci	SaBaT	Patriots	G	W	L	PCT	R	R-
Nuclears Třebíč		9 - 1	20 - 4	13 - 0	3	3	0	1000	42	5
Draci Brno	1 - 9		11 - 1	24 - 0	3	2	1	667	36	10
SaBaT Praha	4 - 20	1 - 11		13 - 8	3	1	2	333	18	39
Patriots Liberec	0 - 13	0 - 24	8 - 13		3	0	3	000	8	50

semifinále / *semi finals*

Eagles Praha 6 - 2 Draci Brno
Nuclears Třebíč 6 - 1 Kotlářka Praha

o 5. místo / *for 5th place*

SaBaT Praha 7 - 8 Arrows Ostrava

o 3. místo / *for 3rd place*

Kotlářka Praha 2 - 0 Draci Brno

finále / *final*

Nuclears Třebíč 2 - 15 Eagles Praha

- | | |
|---|------------------|
| 1 | Eagles Praha |
| 2 | Nuclears Třebíč |
| 3 | Kotlářka Praha |
| 4 | Draci Brno |
| 5 | Arrows Ostrava |
| 6 | SaBaT Praha |
| 7 | Hroši Brno |
| 7 | Patriots Liberec |

Mistrovství republiky U18 2018
Czech Championship U18 2018
(Ostrava - Arrows Otrava)

A	Draci	Eagles	Arrows	G	W	L	PCT	R	R-
Draci Brno		14 - 5	7 - 3	2	2	0	1000	21	8
Eagles Praha	5 - 14		8 - 2	2	1	1	500	13	16
Arrows Ostrava	3 - 7	2 - 8		2	0	2	000	5	15

B	Nuclears	Hroši	Kotlářka	G	W	L	PCT	R	R-
Nuclears Třebíč		3 - 2	10 - 8	2	2	0	1000	13	10
Hroši Brno	2 - 3		6 - 3	2	1	1	500	8	6
Kotlářka Praha	8 - 10	3 - 6		2	0	2	000	11	16

semifinále / *semi finals*

Draci Brno 14 - 4 Hroši Brno
Nuclears Třebíč 9 - 13 Eagles Praha

o 5. místo / *for 5th place*

Arrows Ostrava 6 - 16 Kotlářka Praha

o 3. místo / *for 3rd place*

Hroši Brno 13 - 11 Nuclears Třebíč

finále / *final*

Eagles Praha 10 - 11 Draci Brno

- | | |
|---|-----------------|
| 1 | Draci Brno |
| 2 | Eagles Praha |
| 3 | Hroši Brno |
| 4 | Nuclears Třebíč |
| 5 | Kotlářka Praha |
| 6 | Arrows Ostrava |

Český pohár U15 2018
Czech Cup U15 2018
 (Blansko - Olympia Blansko)

A	Draci	Wolfs	Klasik	G	W	L	D	PCT	R	R-
Draci Brno		19 - 6	11 - 0	3	3	0	0	1000	45	7
Wolfs Domažlice	6 - 19		5 - 3	3	1	2	0	333	12	37
Klasik FM	0 - 11	3 - 5		2	0	2	0	000	3	16
Draci - Wolfs	15 - 1									

B	Eagles	Nuclears	Kotlářka	G	W	L	D	PCT	R	R-
Eagles Praha		5 - 4	18 - 0	3	3	0	0	1000	35	9
Nuclears Třebíč	4 - 5		7 - 1	3	1	2	0	333	16	18
Kotlářka Praha	0 - 18	1 - 7		2	0	2	0	000	1	25
Eagles - Nuclears	12 - 5									

C	Tempo	Hroši	Technika	G	W	L	D	PCT	R	R-
Tempo Titans Praha		1 - 15	9 - 4	3	2	1	0	667	18	22
Hroši Brno	15 - 1		12 - 6	3	2	1	0	667	30	15
Technika Brno	4 - 9	6 - 12		2	0	2	0	000	10	21
Hroši - Tempo	3 - 8									

D	Arrows	Hluboká	Skokani	SaBaT	G	W	L	D	PCT	R	R-
Arrows Ostrava		11 - 0	9 - 5	6 - 3	3	3	0	0	1000	26	8
Sokol Hluboká	0 - 11		5 - 6	11 - 4	3	1	2	0	333	16	21
Skokani Olomouc	5 - 9	6 - 5		4 - 5	3	1	2	0	333	15	19
SaBaT Praha	3 - 6	4 - 11	5 - 4		3	1	2	0	333	12	21

čtvrtfinále / quarter finals

Arrow Ostrava	12 - 2	Wolfs Domažlice
Tempo Titans	6 - 4	Nuclears Třebíč
Draci Brno	12 - 4	Sokol Hluboká
Eagles Praha	12 - 5	Hroši Brno

o 9.-13. místo / for 9-13th place

Klasik FM	2 - 7	Skokani Olomouc
Kotlářka Praha	14 - 0	Technika Brno
Technika Brno	4 - 12	SaBaT Praha
SaBaT Praha	4 - 9	Klasik FM
Klasik FM	17 - 0	Technika Brno

o 5.-8.místo / for 5-8th place

Wolfs Domažlice	3 - 13	Hroši Brno
Nuclears Třebíč	7 - 4	Sokol Hluboká

semifinále / semi finals

Draci Brno	17 - 0	Arrows Ostrava
Eagles Praha	15 - 2	Tempo Titans

o 9. místo / for 9th place

Skokani Olomouc	9 - 11	Kotlářka Praha
-----------------	--------	----------------

o 7. místo / for 7th place

Wolfs Domažlice	3 - 12	Sokol Hluboká
-----------------	--------	---------------

o 5. místo / for 5th place

Nuclears Třebíč	4 - 10	Hroši Brno
-----------------	--------	------------

o 3. místo / for 3rd place

Arrows Ostrava	4 - 10	Tempo Titans
----------------	--------	--------------

finále / final

Draci Brno	9 - 6	Eagles Praha
------------	-------	--------------

1 Draci Brno	8 Wolfs Domažlice
2 Eagles Praha	9 Kotlářka Praha
3 Tempo Titans Praha	10 Skokani Olomouc
4 Arrows Ostrava	11 Klasik Frýdek-Místek
5 Hroši Brno	12 SaBaT Praha
6 Nuclears Třebíč	13 Technika Brno
7 Sokol Hluboká	

Mistrovství republiky U15 2018
Czech Championship U15 2018
 (Brno - Hroši Brno, Technika Brno)

A	Hroši	Draci	Arrows	Wolfs	G	W	L	PCT	R	R-
Hroši Brno		6 - 4	7 - 4	17 - 8	3	3	0	1000	30	16
Draci Brno	4 - 6		15 - 0	30 - 0	3	2	1	667	49	6
Arrows Ostrava	4 - 7	0 - 15		23 - 3	3	1	2	333	27	25
Wolfs Domažlice	8 - 17	0 - 30	3 - 23		3	0	3	000	11	70

B	Eagles	Tempo	Nuclears	Sokol	G	W	L	PCT	R	R-
Eagles Praha		16 - 3	17 - 1	10 - 0	3	3	0	1000	43	4
Tempo Titans	3 - 16		7 - 6	13 - 6	3	2	1	667	23	28
Nuclears Třebíč	1 - 17	6 - 7		10 - 0	3	1	2	333	17	24
Sokol Hluboká	0 - 10	6 - 13	0 - 10		3	0	3	000	6	33

semifinále / *semi finals*

Hroši Brno 19 - 9 Tempo Titans
 Eagles Praha 2 - 6 Draci Brno

o 7. místo / *for 7th place*

Sokol Hluboká 5 - 6 Wolfs Domažlice

o 5. místo / *for 5th place*

Nuclears Třebíč 7 - 15 Arrows Ostrava

o 3. místo / *for 3rd place*

Tempo Titans 10 - 21 Eagles Praha

finále / *final*

Draci Brno 19 - 4 Hroši Brno

- | | |
|---|-----------------|
| 1 | Draci Brno |
| 2 | Hroši Brno |
| 3 | Eagles Praha |
| 4 | Tempo Titans |
| 5 | Arrows Ostrava |
| 6 | Nuclears Třebíč |
| 7 | Wolfs Domažlice |
| 8 | Sokol Hluboká |

Český pohár U13 2018
Czech Cup U13 2018
(Praha - Eagles Praha)

A	Nuclears	SaBaT	Technika	Orli	G	W	L	PCT	R	R-
Nuclears Třebíč		16 - 15	18 - 5	21 - 1	3	3	0	1000	55	21
SaBaT Praha	15 - 16		17 - 0	25 - 4	3	2	1	667	57	20
Technika Brno	5 - 18	9 - 4		21 - 7	3	1	2	333	35	29
Orli Choceň	1 - 21	4 - 25	7 - 21		3	0	3	000	12	67

B	Eagles	Draci	Skokani	Waynes	G	W	L	PCT	R	R-
Eagles Praha		8 - 6	16 - 4	16 - 1	3	3	0	1000	40	11
Draci Brno	6 - 8		23 - 2	20 - 0	3	2	1	667	49	10
Skokani Olomouc	4 - 16	2 - 23		14 - 2	3	1	2	333	20	41
Waynes Pardubice	1 - 16	0 - 20	2 - 14		3	0	3	000	3	50

C	SK	Hroši	Plzeň	Blesk	G	W	L	PCT	R	R-
SK Kotlářka		11 - 8	25 - 4	15 - 0	3	3	0	1000	51	12
Hroši Brno	8 - 11		20 - 0	8 - 5	3	2	1	667	36	16
Baseball Plzeň	4 - 25	0 - 20		8 - 6	3	1	2	333	12	51
Blesk Jablonec	0 - 15	5 - 8	6 - 8		3	0	3	000	11	31

D	Tempo	Arrows	Klasik	Hluboká	G	W	L	PCT	R	R-
Tempo Titans		5 - 4	9 - 3	15 - 5	3	3	0	1000	29	12
Arrows Ostrava	4 - 5		20 - 5	14 - 0	3	2	1	667	38	10
Klasik FM	3 - 9	5 - 20		11 - 10	3	1	2	333	19	39
Sokol Hluboká	5 - 15	0 - 14	10 - 11		3	0	3	000	15	40

čtvrtfinále / quarter finals	Nuclears Třebíč	6 - 0	Arrows Ostrava
	SK Kotlářka	1 - 13	Draci Brno
	Tempo Titans	6 - 5	SaBaT Praha
	Eagles Praha	16 - 9	Hroši Brno

o 13.-16. místo / for 13-16th place	Orli Choceň	6 - 18	Sokol Hluboká
	Waynes Pardubice	1 - 19	Blesk Jablonec
	Orli Choceň	4 - 9	Waynes Pardubice
	Sokol Hluboká	zrušeno	Blesk Jablonec

o 9.-12. místo / for 9-12th place	Skokani Olomouc	15 - 9	Baseball Plzeň
	Klasik FM	6 - 7	Technika Brno

o 5.-8.místo / for 5-8th place	SaBaT Praha	5 - 17	Hroši Brno
	SK Kotlářka	7 - 5	Arrows Ostrava

Český pohár U13 2018
Czech Cup U13 2018
(Praha - Eagles Praha)

semifinále / semi finals

Draci Brno 6 - 10 Eagles Praha
Nuclears Třebíč 11 - 6 Tempo Titans

o 11. místo / for 11th place

Klasik FM 11 - 3 Baseball Plzeň

o 9. místo / for 9th place

Skokani Olomouc 7 - 13 Technika Brno

o 7. místo / for 7th place

Arrows Ostrava 14 - 6 SaBaT Praha

o 5. místo / for 5th place

Hroši Brno 9 - 6 SK Kotlářka

o 3. místo / for 3rd place

Tempo Titans 6 - 14 Draci Brno

finále / final

Eagles Praha 11 - 5 Nuclears Třebíč

1	Eagles Praha	9	Technika Brno
2	Nuclears Třebíč	10	Skokani Olomouc
3	Draci Brno	11	Klasik Frýdek-Místek
4	Tempo Titans Praha	12	Baseball Plzeň
5	Hroši Brno	13	Blesk Jablonec
6	SK Kotlářka Praha	14	Sokol Hluboká
7	Arrows Ostrava	15	Waynes Pradubice
8	SaBaT Praha	16	Orli Choceň

Mistrovství republiky U13 2018
Czech Championship U13 2018
(Praha - SaBaT Praha, Ostrava - Arrows Ostrava)

Kvalifikace / Qualification

A	Eagles	Tempo	Hroši	Blesk	SaBaT	G	W	L	PCT	R	R-
Eagles Praha		9 - 7	11 - 6	11 - 1	14 - 2	4	4	0	1000	45	16
Tempo Titans	7 - 9		8 - 6	16 - 13	11 - 0	4	3	1	750	42	28
Hroši Brno	6 - 11	6 - 8		8 - 9	16 - 0	4	1	3	250	36	28
Blesk Jablonec	1 - 11	13 - 16	9 - 8		7 - 14	4	1	3	250	30	49
SaBaT Praha	2 - 14	0 - 11	0 - 16	14 - 7		4	1	3	250	16	48

B	SK	Draci	Arrows	Nuclears	Klasik	G	W	L	PCT	R	R-
SK Kotlářka Praha		8 - 5	15 - 8	12 - 13	22 - 3	4	3	1	750	57	29
Draci Brno	5 - 8		13 - 3	14 - 4	16 - 0	4	3	1	750	48	15
Arrows Ostrava	8 - 15	3 - 13		4 - 2	15 - 0	4	2	2	500	30	30
Nuclears Třebíč	13 - 12	4 - 14	2 - 4		14 - 4	4	2	2	500	33	34
Klasik Frýdek-Místek	3 - 22	0 - 16	0 - 15	4 - 14		4	0	4	000	7	67

Mistrovství republiky U13 2018
Czech Championship U13 2018
(Praha - Eagles Praha)

A	Eagles	Arrows	Draci	G	W	L	PCT	R	R-
Eagles Praha		10 - 0	7 - 4	2	2	0	1000	17	4
Arrows Ostrava	0 - 10		8 - 7	2	1	1	500	8	17
Draci Brno	4 - 7	7 - 8		2	0	2	000	11	15

B	SK	Tempo	Hroši	G	W	L	PCT	R	R-
SK Kotlářka		15 - 7	14 - 7	2	2	0	1000	29	14
Tempo Titans	7 - 15		11 - 4	2	1	1	500	18	19
Hroši Brno	7 - 14	4 - 11		2	0	2	000	11	25

semifinále / *semi finals*
Eagles Praha 10 - 0 Tempo Titans
SK Kotlářka Praha 1 - 0 Arrows Ostrava

o 5. místo / *for 5th place*
Draci Brno 14 - 4 Hroši Brno
o 3. místo / *for 3rd place*
Arrows Ostrava 14 - 24 Tempo Titans

finále / *final*
SK Kotlářka Praha 4 - 6 Eagles Praha

- | | |
|---|--------------------|
| 1 | Eagles Praha |
| 2 | SK Kotlářka Praha |
| 3 | Tempo Titans Praha |
| 4 | Arrows Ostrava |
| 5 | Draci Brno |
| 6 | Hroši Brno |

Český pohár žáků U11 2018
Czech Juvenile Cup U11 2018
(Hluboká - Sokol Hluboká)

A	Hroši	Technika	SaBaT	SK	Oilers	G	W	L	PCT	R	R-
Hroši Brno		25 - 0	10 - 7	26 - 1	18 - 1	4	4	0	1000	79	9
Technika Brno	0 - 25		19 - 1	11 - 10	12 - 5	4	3	1	750	42	41
SaBaT Praha	7 - 10	1 - 19		7 - 5	14 - 0	4	2	2	500	29	34
SK Kotlářka	1 - 26	10 - 11	5 - 7		7 - 6	4	1	3	250	23	50
Oilers Hodonín	1 - 18	5 - 12	0 - 14	6 - 7		4	0	4	000	12	51

B	Draci	Tempo	Joudrs	Blesk	Piranhas	G	W	L	PCT	R	R-
Draci Brno		9 - 7	13 - 9	9 - 1	18 - 2	4	4	0	1000	49	19
Tempo Titans	7 - 9		10 - 6	14 - 5	18 - 9	4	3	1	750	49	29
Joudrs Praha	9 - 13	6 - 10		13 - 1	13 - 0	4	2	2	500	41	24
Blesk Jablonec	1 - 9	5 - 14	1 - 13		6 - 2	4	1	3	250	13	38
Piranhas Beroun	2 - 18	9 - 18	0 - 13	2 - 6		4	0	4	000	13	55

C	Olympia	Sokol	Plzeň	Arrows	G	W	L	PCT	R	R-
Olympia Blansko		9 - 12	11 - 7	16 - 7	4	3	1	750	49	29
Sokol Hluboká	12 - 9		7 - 0	6 - 2	4	3	1	750	28	24
Baseball Plzeň	7 - 11	0 - 7		10 - 9	3	1	2	333	17	27
Arrows Ostrava	7 - 16	2 - 6	9 - 10		3	0	3	000	18	32
Hluboká - Blansko	3 - 13									

D	Nuclears	Klasik	Eagles	Rytíři	G	W	L	PCT	R	R-
Nuclears Třebíč		13 - 5	23 - 0	7 - 1	4	4	0	1000	58	8
Klasik FM	5 - 13		11 - 10	7 - 0	4	2	2	500	25	38
Eagles Praha	0 - 23	10 - 11		9 - 2	3	1	2	333	19	36
Rytíři Trutnov	1 - 7	0 - 7	2 - 9		3	0	3	000	3	23
Nuclears - Klasik	15 - 2									

čtvrtfinále / quarter finals

Nuclears Třebíč	15 - 6	Technika Brno
Hroši Brno	11 - 2	Klasik FM
Draci Brno	8 - 1	Sokol Hluboká
Olympia Blansko	7 - 6	Tempo Titans

o 5.-8. místo / for 5-8th place

Tempo Titans	9 - 8	Technika Brno
Sokol Hluboká	8 - 1	Klasik FM

o 13.-18. místo / for 13-18th place

SaBaT Praha	7 - 6	Eagles Praha
Joudrs Praha	7 - 18	Basebal Plzeň
Blesk Jablonec	11 - 1	Arrows Ostrava
SK Kotlářka	9 - 7	Rytíři Trutnov
Klasik FM	17 - 0	Technika Brno
Rytíři Trutnov	15 - 0	Piranhas Beroun
Arrows Ostrava	9 - 19	Oilers Hodonín
Piranhas Beroun	18 - 19	Arrows Ostrava
Rytíři Trutnov	6 - 4	Oilers Hodonín

Český pohár žáků U11 2018
Czech Juvenile Cup U11 2018
 (Hluboká - Sokol Hluboká)

semifinále / *semi finals*

Hroši Brno 8 - 3 Nuclears Třebíč
 Draci Brno 4 - 2 Olympia Blansko

o 13. místo / *for 1th place*

SK Kotlářka 11 - 9 Blesk Jablonec

o 11. místo / *for 11th place*

Eagles Praha 3 - 26 Joudrs Praha

o 9. místo / *for 9th place*

SaBaT Praha 26 - 1 Baseball Plzeň

o 7. místo / *for 7th place*

Technika Brno 2 - 8 Klasik FM

o 5. místo / *for 5th place*

Tempo Titans 7 - 2 Sokol Hluboká

o 3. místo / *for 3rd place*

Olympia Blansko 3 - 13 Nuclears Třebíč

finále / *final*

Draci Brno 11 - 14 Hroši Brno

1 Hroši Brno	10 Baseball Plzeň
2 Draci Brno	11 Ejoudrs Praha
3 Nuclears Třebíč	12 Eagles Praha
4 Olympia Blansko	13 SK Kotlářka Praha
5 Tempo Titans Praha	14 Blesk Jablonec
6 Sokol Hluboká	15 Rytíři Trutnov
7 Klasik Frýdek-Místek	16 Oilers Hodonín
8 Technika Brno	17 Arrows Ostrava
9 SaBaT Praha	18 Piranhas Beroun

Mistrovství republiky U11 2018
Czech Championship U11 2018
 (Blansko - Olympia Blansko, Hluboká - Sokol Hluboká)

Kvalifikace / Qualification

A	Hroši	Olympia	Tempo	SK	Technika	G	W	L	PCT	R	R-
Hroši Brno		12 - 1	17 - 2	21 - 1	14 - 8	4	4	0	1000	64	12
Olympia Blansko	1 - 12		7 - 3	9 - 2	10 - 9	4	3	1	750	27	26
Tempo Titans	2 - 17	3 - 7		5 - 12	19 - 5	4	1	3	250	29	41
SK Kotlářka	1 - 21	2 - 9	12 - 5		6 - 11	4	1	3	250	21	46
Technika Brno	8 - 14	9 - 10	5 - 19	11 - 6		4	1	3	250	33	49

B	Draci	Nuclears	Sokol	Blesk	Klasik	G	W	L	PCT	R	R-
Draci Brno		9 - 3	12 - 11	10 - 7	15 - 5	4	4	0	1000	46	26
Nuclears Třebíč	3 - 9		8 - 4	6 - 5	9 - 0	4	3	1	750	26	18
Sokol Hluboká	11 - 12	4 - 8		9 - 7	16 - 2	4	2	2	500	40	29
Blesk Jablonec	7 - 10	5 - 6	7 - 9		7 - 2	4	1	3	250	26	27
Klasik FM	5 - 15	0 - 9	2 - 16	2 - 7		4	0	4	000	9	47

Mistrovství republiky U11 2018
Czech Championship U11 2018
 (Třebíč - Nuclears Třebíč)

A	Hroši	Nuclears	Sokol	G	W	L	PCT	R	R-
Hroši Brno		17 - 8	20 - 5	2	2	0	1000	37	13
Nuclears Třebíč	8 - 17		7 - 4	2	1	1	500	15	21
Sokol Hluboká	5 - 20	4 - 7		2	0	2	000	9	27

B	Draci	Tempo	Olympia	G	W	L	PCT	R	R-
Draci Brno		8 - 0	15 - 6	2	2	0	1000	23	6
Tempo Titans	0 - 8		8 - 6	2	1	1	500	8	14
Olympia Blansko	6 - 15	6 - 8		2	0	2	000	12	23

semifinále / <i>semi finals</i>	Hroši Brno	19 - 2	Tempo Titans
	Draci Brno	14 - 6	Nuclears Třebíč
o 5. místo / <i>for 5th place</i>	Sokol Hluboká	7 - 3	Olympia Blansko
o 3. místo / <i>for 3rd place</i>	Tempo Titans	1 - 20	Nuclears Třebíč
finále / <i>final</i>	Hroši Brno	3 - 0	Draci Brno

1	Hroši Brno
2	Draci Brno
3	Nuclears Třebíč
4	Tempo Titans Praha
5	Sokol Hluboká
6	Olympia Blansko

Český pohár U10 2018
Czech Cup U10 2018
(Hluboká - Sokol Hluboká)

A	Draci	Olympia	Ježci	Klasik	HIT	G	W	L	PCT	R	R-
Draci Brno		8 - 5	17 - 0	17 - 1	17 - 0	4	4	0	900	59	6
Olympia Blansko	5 - 8		6 - 0	8 - 2	15 - 0	4	3	1	750	34	10
Ježci Jihlava	0 - 17	0 - 6		5 - 3	15 - 2	4	2	2	700	20	28
Klasik FM	1 - 17	2 - 8	3 - 5		9 - 5	4	1	3	250	15	35
HIT Opava	0 - 17	0 - 15	2 - 15	5 - 9		4	0	4	000	7	56

B	Hroši	Hluboká	Rytíři	Technika	G	W	L	PCT	R	R-
Hroši Brno		10 - 2	12 - 3	14 - 0	3	3	0	1000	47	8
Sokol Hluboká	2 - 10		5 - 3	13 - 0	3	2	1	667	23	24
Rytíři Trutnov	3 - 12	3 - 5		11 - 4	3	1	2	333	17	21
Technika Brno	0 - 14	0 - 13	4 - 11		3	0	3	000	4	38
Hroši - Hluboká	11 - 3									

C	Tempo	Eagles	Oilers	Skokani	G	W	L	PCT	R	R-
Tempo Titans		5 - 4	6 - 3	11 - 2	3	3	0	1000	23	9
Eagles Praha	4 - 5		7 - 4	15 - 2	3	2	1	667	26	12
Oilers Hodonín	3 - 6	4 - 7		10 - 3	3	1	2	333	17	16
Skokani Olomouc	2 - 11	2 - 15	3 - 10		3	0	3	000	7	36
Tempo - Eagles	1 - 0									

D	Nuclears	Arrows	Brewers	Plzeň	Wolfs	G	W	L	PCT	R	R-
Nuclears Třebíč		16 - 2	22 - 2	21 - 3	15 - 2	4	4	0	1000	74	9
Arrows Ostrava	2 - 16		7 - 8	8 - 5	18 - 3	4	2	2	500	35	32
Brewers Klatovy	2 - 22	8 - 7		9 - 10	17 - 7	4	2	2	900	36	46
Baseball Plzeň	3 - 21	5 - 8	10 - 9		16 - 7	4	2	2	500	34	45
Wolfs Domažlice	2 - 15	3 - 18	7 - 17	7 - 16		4	0	4	900	19	66

čtvrtfinále / quater finals

Hroši Brno	5 - 1	Eagles Praha
Tempo Titans	1 - 4	Sokol Huboká
Draci Brno	16 - 0	Arrows Ostrava
Nuclears Třebíč	10 - 2	Olympia Blansko

o 5.-8. místo / for 5th-8th place

Eagles Praha	2 - 5	Olympia Blansko
Arrows Ostrava	1 - 11	Tempo Titans

o 9.-12. místo / for 12th-12th place

Ježci Jihlava	3 - 4	Brewers Klatovy
Rytíři Trutnov	4 - 3	Oilers Hodonín

o 13.-16. místo / for 13th-16th place

Klasik FM	8 - 2	Technika Brno
Skokani Olomouc	5 - 7	Baseball Plzeň

Český pohár U10 2018
Czech Cup U10 2018
(Hluboká - Sokol Hluboká)

semifinále / *semi finals*

Hroši Brno 9 - 0 Nuclears Třebíč

Draci Brno 11 - 2 Sokol Hluboká

o 17. místo / *for 17th place*

HIT Opava 10 - 8 Wolfs Domažlice

o 15. místo / *for 15th place*

Technika Brno 3 - 8 Skokani Olomouc

o 13. místo / *for 13th place*

Klasik FM 4 - 3 Baseball Plzeň

o 11. místo / *for 11th place*

Ježci Jihlava 0 - 9 Oilers Hodonín

o 9. místo / *for 9th place*

Brewers Klatovy 4 - 3 Rytíři Trutnov

o 7. místo / *for 7th place*

Eagles Praha 3 - 2 Arrows Ostrava

o 5. místo / *for 5th place*

Olympia Blansko 2 - 7 Tempo Titans

o 3. místo / *for 3rd place*

Nuclears Třebíč 11 - 0 Sokol Hluboká

finále / *final*

Hroši Brno 4 - 0 Draci Brno

1 Hroši Brno	7 Eagles Praha	13 Klasik Frýdek-Místek
2 Draci Brno	8 Arrows Ostrava	14 Baseball Plzeň
3 Nuclears Třebíč	9 Brewers Klatovy	15 Skokani Olomouc
4 Sokol Hluboká	10 Rytíři Trutnov	16 Technika Brno
5 Tempo Titans Praha	11 Oilers Hodonín	17 HIT Opava
6 Olympia Blansko	12 Ježci Jihlava	18 Wolfs Domažlice

Český pohár U9 2018 kvalifikace
Czech Cup U9 2018 qualification

Skupina 1 / Group 1

Eagles Praha

- | | |
|---|-------------------|
| 1 | Eagles Praha |
| 2 | Kotlářka Praha |
| 3 | Baseball Plzeň |
| 4 | SC 80 Chomutov* |
| 5 | Sokol Hluboká |
| 6 | Painbusters Most |
| 7 | Brewers Klatovy |
| 8 | Pigs Trhové Sviny |

*vzdal se účasti na MČR

Skupina 2 / Group 2

Draci Brno

- | | |
|---|------------------|
| 1 | Draci Brno |
| 2 | Nuclears Třebíč |
| 3 | Pipas Brno |
| 4 | Hroch Brno |
| 5 | Arrows Ostrava |
| 6 | Skokani Olomouc |
| 7 | Žraloci Ledenice |
| 8 | Havlíčkův Brod |

Skupina 3 / Group 3

Blesk Jablonec

- | | |
|---|-----------------------|
| 1 | Tempo Titans Praha |
| 2 | Blesk Jablonec |
| 3 | Rytíři Trutnov |
| 4 | Miners Kladno |
| 5 | SaBaT Praha |
| 6 | Joudrs Praha |
| 7 | Rakovník Red Crayfish |
| 8 | Baryba Velký Osek |

Skupina 4

Olympia Blansko

- | | |
|---|----------------------|
| 1 | Olympia Blansko |
| 2 | Hroši Brno |
| 3 | Oilers Hodonín |
| 4 | Technika Brno |
| 5 | Ježci Jihlava |
| 6 | Snails Kunovice |
| 7 | HIT Opava |
| 8 | SK Klackaři Kostelec |
| 9 | Klasik Frydek-Místek |

Mistrovství republiky U9 2018
Czech Championship U9 2018
(Hluboká - Sokol Hluboká)

A	Nuclears	Olympia	Plzeň	Miners	G	W	L	PCT	R	R-
Nuclears Třebíč		9 - 6	15 - 0	8 - 7	3	3	0	1000	32	13
Olympia Blanko	6 - 9		9 - 4	13 - 3	3	2	1	667	28	16
Baseball Plzeň	0 - 15	4 - 9		9 - 8	3	1	2	333	13	32
Miners Kladno	7 - 8	3 - 13	8 - 9		3	0	3	000	18	30

B	Draci	Rytíři	Technika	Kotlářka	G	W	L	PCT	R	R-
Draci Brno		7 - 6	14 - 1	13 - 1	3	3	0	1000	34	8
Rytíři Trutnov	6 - 7		10 - 4	8 - 3	3	2	1	667	24	14
Technika Brno	1 - 14	4 - 10		8 - 6	3	1	2	333	13	30
Kotlářka Praha	1 - 13	3 - 8	6 - 8		3	0	3	000	10	29

C	Eagles	Hroch	Oilers	Blesk	G	W	L	PCT	R	R-
Eagles Praha		9 - 1	12 - 3	13 - 2	3	3	0	1000	34	6
Hroch Brno	1 - 9		6 - 3	7 - 5	3	2	1	667	14	17
Oilers Hodonín	3 - 12	3 - 6		9 - 2	3	1	2	333	15	20
Blesk Jablonec	2 - 13	5 - 7	2 - 9		3	0	3	000	9	29

D	Hroši	Pipas	Tempo	Hluboká	G	W	L	PCT	R	R-
Hroši Brno		8 - 3	9 - 3	20 - 0	3	3	0	1000	37	6
Pipas Brno	3 - 8		10 - 2	11 - 1	3	2	1	667	24	11
Tempo Titan	3 - 9	2 - 10		14 - 0	3	1	2	333	19	19
Sokol Hluboká	0 - 20	1 - 11	0 - 14		3	0	3	000	1	45

osmifinále / eight finals

Olympia Blansko	12 - 3	Technika Brno
Rytíři Trutnov	0 - 8	Oilers Hodonín
Hroch Brno	5 - 6	Tempo Titans
Pipa Brno	5 - 8	Baseball Plzeň

čtvrtfinále / quarter finals

Hroši Brno	8 - 3	Olympia Blansko
Nuclear Třebíč	6 - 3	Oilers Hodonín
Draci Brno	12 - 6	Tempo Titans
Eagles Praha	8 - 10	Baseball Plzeň

o 13.-16. místo / for 13-16th place

Miners Kladno	6 - 5	Kotlářka Praha
Blesk Jablonec	14 - 1	Sokol Hluboká
Kotlářka Praha	3 - 2	Blesk Jablonec
Sokol Hluboká	1 - 6	Miners Kladno
Miners Kladno	6 - 3	Blesk Jablonec
Kotlářka Praha	11 - 10	Sokol Hluboká

o 9.-12. místo / for 9-12th place

Technika Brno	8 - 7	Rytíři Trutnov
Hroch Brno	0 - 11	Pipas Brno
Rytíři Trutnov	1 - 6	Hroch Brno
Pipas Brno	6 - 1	Technika Brno
Technika Brno	5 - 4	Hroch Brno
Oilers Hodonín	7 - 2	Pipas Brno

Mistrovství republiky U9 2018
Czech Championship U9 2018
 (Hluboká - Sokol Hluboká)

o 5.-8.místo / *for 5-8th place*

Olympia Blansko 2 - 0 Tempo Titans
 Oilers Hoonín 1 - 9 Eagles Praha

semifinále / *semi finals*

Hroši Brno 6 - 7 Draci Brno
 Nuclears Třebíč 5 - 4 Baseball Plzeň

o 7. místo / *for 7th place*

Tempo Titans 6 - 9 Oilers Hodonín

o 5. místo / *for 5th place*

Olympia Blansko 13 - 10 Eagles Praha

o 3. místo / *for 3rd place*

Hroši Brno 16 - 2 Baseball Plzeň

finále / *final*

Draci Brno 9 - 3 Nuclears Třebíč

1 Draci Brno	9 Pipas Brno
2 Nuclears Třebíč	10 Technika Brno
3 Hroši Brno	11 Hroch Brno
4 Baseball Plzeň	12 Rytíři Trutnov
5 Olympia Blansko	13 Miners kladno
6 Eagles Praha	14 Kotlářka Praha
7 Oilers Hodonín	15 Blesk Jablonec
8 Tempo Titans Praha	16 Sokol Hluboká

Český pohár U8 2018 - Čechy
Czech Cup U8 2018 - Czechia
 (Trutnov - Rytíři Trutnov)

A	Miners	Eagles	Rytíři	Orli	G	W	L	PCT	R	R-
Miners Kladno		20 - 2	16 - 2	25 - 3	3	3	0	1000	61	7
Eagles Praha	2 - 20		14 - 12	17 - 12	3	2	1	667	33	44
Rytíři Trutnov	2 - 16	12 - 14		19 - 2	3	1	2	333	33	32
Orli Choceň	3 - 25	12 - 17	2 - 19		3	0	3	000	17	61

B	Kotlářka	Tempo	Plzeň	G	W	L	PCT	R	R-
Kotlářka Praha		2 - 13	8 - 7	3	2	1	667	19	26
Tempo Titans	13 - 2		19 - 6	3	2	1	667	38	17
Baseball Plzeň	7 - 8	6 - 19		2	0	2	000	13	27
Tempo - Kotlářka	6 - 9								

semifinále / semi finals

Kotlářka Praha 5 - 6 Eagles Praha
 Miners Kladno 19 - 4 Tempo Titans

o 5.-8. místo / for 5th-8th place

Rytíři Trutnov 15 - 9 Baseball Plzeň
 Orli Choceň 5 - 17 Rytíři Trutnov
 Baseball Plzeň 13 - 12 Orli Choceň

o 3. místo / for 3rd place

Tempo Titans 6 - 9 Kotlářka Praha

finále / final

Miners Kladno 13 - 3 Eagles Praha

1	Miners Kladno
2	Eagles Praha
3	Kotlářka Praha
4	Tempo Titans Praha
5	Rytíři Trutnov
6	Baseball Plzeň
7	Orli Choceň

Český pohár U8 2018 - Morava
Czech Cup U8 2018 - Moravia
 (Blansko - Olympia Blansko)

A	Nuclears	Draci	Pipas	Pelikans	G	W	L	PCT	R	R-
Nuclears Třebíč		13 - 8	13 - 5	23 - 5	3	3	0	1000	49	18
Draci Brno	8 - 13		13 - 11	13 - 2	3	2	1	667	34	26
Pipas Brno	5 - 13	11 - 13		23 - 0	3	1	2	333	39	26
Pelikans Bučovice	5 - 23	2 - 13	0 - 23		3	0	3	000	7	59

B	Olympia	Hroch	Arrows	Ježci	G	W	L	PCT	R	R-
Olympia Blansko		20 - 4	21 - 8	17 - 0	3	3	0	1000	58	12
Hroch Brno	4 - 20		20 - 5	15 - 3	3	2	1	667	39	28
Arrows Ostrava	8 - 21	5 - 20		15 - 11	3	1	2	333	28	52
Ježci Jihlava	0 - 17	3 - 15	11 - 15		3	0	3	000	14	47

semifinále / *semi finals*

Olympia Blansko 16 - 5 Draci Brno
 Nuclears Třebíč 12 - 17 Hroch Brno

o 5.-8. místo / *for 5th-8th place*

Pipas Brno 15 - 14 Ježci Jihlava
 Arrows Ostrava 13 - 7 Pelikans Bučovice

o 7. místo / *for 7th place*

Pelikans Bučovice 7 - 20 Ježci Jihlava

o 5. místo / *for 5th place*

Pipas Brno 13 - 12 Arrows Ostrava

o 3. místo / *for 3rd place*

Draci Brno 6 - 15 Hroch Brno

finále / *final*

Třebíč Nuclears 12 - 17 Olympia Blansko

- | | |
|---|-------------------|
| 1 | Olympia Blansko |
| 2 | Nuclears Třebíč |
| 3 | Hroch Brno |
| 4 | Draci Brno |
| 5 | Pipas Brno |
| 6 | Arrows Ostrava |
| 7 | Ježci jihlava |
| 8 | Pelikans Bučovice |

Kvalifikace Junior League 2018
Qualification Junior League 2018
 (region Jihozápad - Sokol Hluboká)

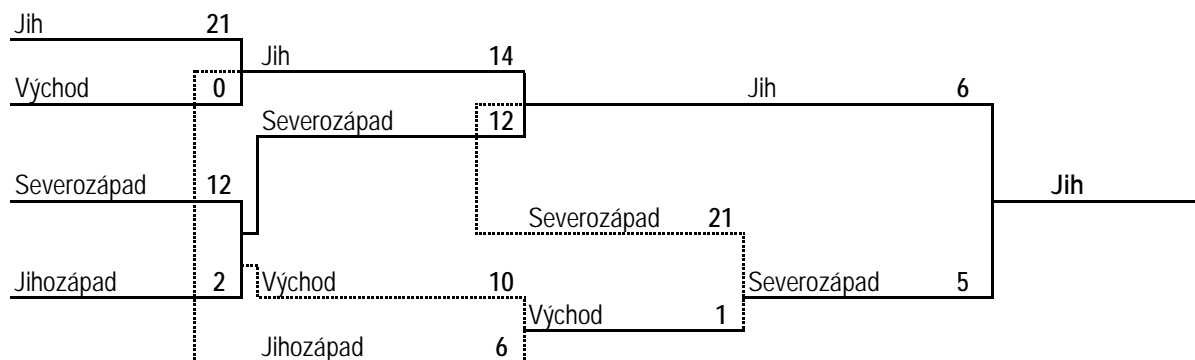

na dvě prohry
 double-elimination tournament

vítěz / winner

 poražený / loser

- | | |
|---|--------------------|
| 1 | Region Jih |
| 2 | Region Severozápad |
| 3 | Region Východ |
| 4 | Region Jihozápad |

Kvalifikace Little League 2018
Qualification Little League 2018
 (region Východ - Skokani Olomouc)

Východ - Severovýchod	15 - 14
Severozápad - Jihozápad	16 - 0
Východ - Jih	2 - 18
Severovýchod - Jihozápad	5 - 12
Jihozápad - Východ	6 - 13
Severozápad - Jih	5 - 11
Severozápad - Východ	11 - 1
Jih - Severozápad	5 - 11

- | | |
|---|---------------------|
| 1 | Region Severozápad |
| 2 | Region Jih |
| 3 | Region Jihozápad |
| 4 | Region Východ |
| 5 | Region Severovýchod |

Kvalifikace Senior League 2018
Qualification Senior League 2018
 (region Severozápad - Praotci Roudnice)

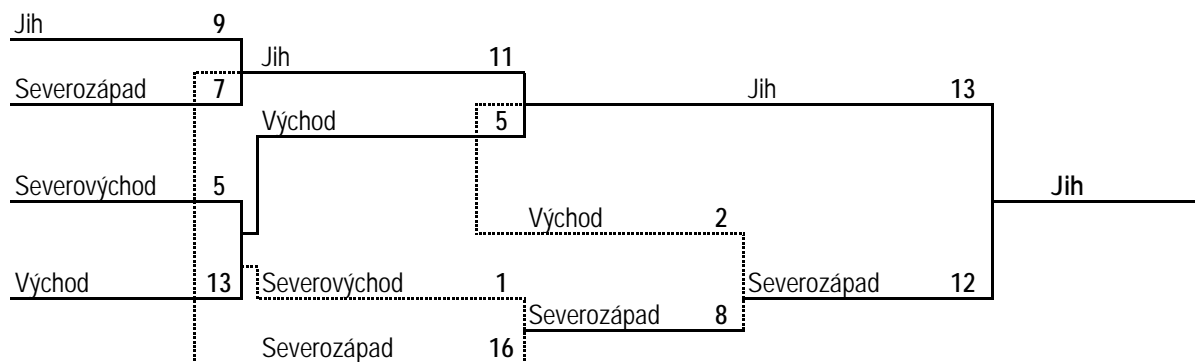

na dvě prohry
 double-elimination tournament

vítěz / winner

 poražený / loser

- | | |
|---|---------------------|
| 1 | Region Jih |
| 2 | Region Severozápad |
| 3 | Region Východ |
| 4 | Region Severovýchod |

Rozhodovaná utkání v sezóně 2018

Games umpired in season 2018

Rozhodčí	Extraliga		1.Liga	Soutěž o ExL	Soutěž o 1.Ligu	Český pohár	Exl U21 +U18	MČR + ČBP			Celkem	
	zákl.č.	pf+pd						U15	U13	U11		U9
T. Adamec	11	1	-	1	-	-	-	-	-	-	-	13
V. Bartoš	7	1	8	-	-	-	-	-	-	-	-	16
O. Beneš	18	3	6	4	-	3	29	14	3	-	-	80
T. Bílek	-	-	-	-	-	-	1	-	-	-	-	1
J. Borůvka	-	-	-	2	-	-	4	-	-	-	-	6
L. Bukaj	-	-	-	-	-	-	-	-	-	-	7	7
O. Bulvas	1	-	2	-	-	-	-	-	-	-	-	3
J. Cihlár	-	-	-	-	-	-	1	-	-	-	-	1
Da. Černý	-	-	-	-	-	-	-	-	1	-	-	1
O. Čordáš	-	-	-	-	-	-	1	-	-	-	-	1
M. Dědek	5	3	9	2	-	-	12	-	12	-	-	43
R. Demuth	-	-	-	-	-	-	-	-	-	-	7	7
Ja. Drábek	-	-	-	-	-	-	-	-	2	-	-	2
Ji. Drábek	-	-	-	-	-	-	1	-	-	-	-	1
R. Drápal	18	4	-	4	-	1	2	-	-	-	-	29
M. Draxler	-	-	-	-	-	-	-	-	-	-	14	14
M. Dufek	7	2	4	3	-	1	6	-	-	-	-	23
L. Durlin	-	-	-	-	-	-	-	-	-	-	1	1
M. Dvořák	-	-	-	-	-	-	-	1	-	-	-	1
D. Fejta	-	-	-	-	-	-	-	-	-	-	6	6
P. Gray	-	-	-	-	-	-	-	-	5	-	-	5
J. Grossmann	-	-	-	-	-	-	-	-	-	-	3	3
M. Hadzima	4	4	4	1	-	1	1	-	-	-	-	15
A. Haladej	-	-	2	-	-	-	-	-	-	-	-	2
F. Havlík	-	-	12	3	-	2	7	-	11	-	-	35
M. Hejmánek	-	-	-	-	-	-	1	-	-	-	-	1
J. Híkl	-	-	-	-	-	-	2	-	-	-	-	2
L. Hlouch	-	-	-	-	-	-	-	-	-	7	6	13
R. Holcapfel	10	6	4	3	-	-	-	-	-	-	-	23
P. Horký	-	-	-	-	-	-	-	9	9	-	-	18
K. Hřůza	-	-	-	-	-	-	-	-	-	-	4	4
M. Hřib	-	-	-	-	-	-	1	1	-	-	4	6
D. Hubbard	-	-	-	-	-	-	1	-	-	-	-	1
O. Humpolec	-	-	-	-	-	-	-	-	-	11	9	20
D. Chalupa	-	-	8	3	-	1	18	4	-	3	-	37
V. Chlup	-	-	-	-	-	-	3	-	-	-	-	3
K. Jaksch	5	3	2	-	-	1	13	-	3	-	-	27
P. Janda	-	2	12	4	-	1	6	-	-	26	13	64
M. Jankovič	13	7	-	1	-	-	-	-	-	-	-	21
P. Jarošová	-	-	-	-	-	-	-	-	-	-	9	9
D. Javorský	-	-	-	-	-	-	3	-	-	-	-	3

Rozhodovaná utkání v sezóně 2018
Games umpired in season 2018

Umpire	Extra League		First Leag.	ExL Qualif.	First Leag. Qualif.	Czech Cup	Exl U21+ U18	Czech Champ. + Czech Cup				Total
	round robin	play off						U15	U13	U11	U9	
J. Kabele	-	-	-	-	-	-	-	-	1	-	-	1
L. Kabeš	-	-	-	-	-	-	-	6	-	-	-	6
R. Kachtík	13	4	5	10	0	2	4	-	6	-	-	44
M. Kaigl	10	17	2	1	-	1	1	-	-	4	-	36
P. Kasperčík	-	-	-	-	-	-	2	-	-	-	-	2
P. Kavan	-	-	-	-	-	-	-	-	-	-	9	9
R. Klempíř	-	-	-	-	-	-	-	-	-	-	1	1
Kolčaba	-	-	-	-	-	-	1	-	-	-	-	1
V. Kolev	-	-	-	-	-	-	-	-	6	-	-	6
J. Konrád	-	-	-	-	-	-	1	-	-	-	-	1
M. Konvalinka	-	-	-	-	-	-	-	4	-	4	2	10
M. Kotačka	-	-	2	-	-	-	5	-	-	-	-	7
R. Koudelka	-	-	-	-	-	-	-	-	8	-	-	8
O. Koukal	-	-	-	-	-	-	-	-	-	-	4	4
T. Kovala	-	-	-	-	-	-	2	-	-	-	-	2
J. Kroupa	27	15	6	3	-	1	8	1	-	-	-	61
F. Kučera	-	-	2	4	-	-	12	-	3	-	-	21
D. Kulhánek	16	11	-	-	-	-	2	-	-	2	-	31
A. Lakota	-	-	-	-	-	-	-	-	-	2	-	2
V. Mach	-	-	4	2	-	-	4	-	-	-	-	10
J. Mañas	-	-	10	-	-	-	-	-	3	9	-	22
J. Mareš	-	-	-	-	-	-	4	-	-	-	-	4
M. Mazura	-	-	-	-	-	-	5	-	-	-	-	5
K. McDowall	-	-	-	-	-	-	1	-	-	-	-	1
J. Městka	-	-	-	-	-	-	1	-	-	-	-	1
J. Michalec	-	-	-	-	-	-	-	-	-	33	12	45
V. Minařík	-	-	-	-	-	-	-	-	-	-	9	9
F. Moštěk	-	-	-	-	-	-	1	-	-	-	-	1
P. Moštěk	-	-	-	-	-	-	-	-	-	-	4	4
M. Němčanský	-	-	-	-	-	-	-	-	-	-	3	3
P. Neubauer	-	-	-	-	-	-	-	-	-	3	-	3
M. Nováček	-	-	-	-	-	-	2	1	-	-	-	3
J. Novota	1	3	8	4	-	-	9	-	-	12	-	37
B. O'Rourke	-	-	-	-	-	-	-	-	-	-	5	5
P. Podhájecký	-	-	2	-	-	1	-	-	4	4	-	11
D. Podroužek	-	-	-	-	-	-	-	-	-	-	6	6
M. Polášek	-	-	-	-	-	-	4	-	-	-	-	4
J. Prokop	17	3	4	7	-	-	-	-	-	-	-	31
H. Prukner	4	-	-	1	-	1	4	-	-	-	-	10
F. Příbyl	10	14	1	-	-	-	5	-	-	8	-	38
V. Richter	14	12	7	2	-	4	1	-	-	-	8	48

Rozhodovaná utkání v sezóně 2018
Games umpired in season 2018

Rozhodčí	Extraliga		1.Liga	Soutěž o ExL	Soutěž o 1.Ligu	Český pohár	Exl U21 +U18	MČR + ČBP			Celkem	
	zákl.č.	pf+pd						U15	U13	U11		U9
M. Rotter	5	3	15	6	-	2	2	-	-	-	-	33
M. Rumler	9	3	8	4	-	4	9	6	-	7	-	50
B. Rychecký	12	5	2	3	-	1	1	-	-	-	-	24
O. Rypar	-	-	-	-	-	-	-	-	-	-	3	3
D. Sandoval	-	-	-	-	-	-	-	-	2	-	-	2
T. Sedláček	-	-	-	-	-	-	4	9	-	-	-	13
D. Sklenář	-	-	-	-	-	-	-	-	-	7	-	7
M. Smolný	-	-	-	-	-	-	9	12	14	-	-	35
M. Surý	-	-	-	-	-	-	2	-	-	-	-	2
S. Swagerty	-	-	-	-	-	-	2	-	-	-	-	2
R. Šimota	5	2	8	3	-	1	12	-	-	-	-	31
J. Školoudík	-	-	-	-	-	-	-	-	-	12	-	12
T. Špilauer	5	2	8	7	-	2	11	-	4	41	10	90
P. Šrámek	-	-	2	-	-	-	-	-	-	-	-	2
J. Štrba	-	-	2	-	-	-	-	-	-	-	-	2
J. Šustal	-	-	-	-	-	-	-	-	-	-	3	3
T. Šustrová	-	-	-	-	-	-	-	-	-	-	4	4
J. Tesařík	2	-	10	5	-	-	10	5	-	-	-	32
T. Thurber	-	-	-	-	-	-	-	-	3	-	-	3
P. Toman	7	-	-	-	-	-	11	-	-	-	-	18
R. Tůma	-	3	6	-	-	-	9	-	19	-	-	37
M. Tyc	-	-	-	-	-	-	-	-	-	20	-	20
J. Uhlíř	-	-	-	-	-	-	-	-	-	-	5	5
O. Vaňáč	-	-	-	-	-	-	-	-	1	-	-	1
B. Večerka	-	-	-	-	-	-	-	-	-	-	4	4
R. Vedlich	8	4	-	2	-	-	10	-	4	-	-	28
M. Vičar	29	17	10	-	-	2	27	6	13	-	-	104
A. Vítek	-	-	-	-	-	-	2	-	-	-	-	2
M. Vlček	-	-	2	-	-	-	2	10	-	-	-	14
T. Volný	-	-	-	-	-	-	2	-	6	-	-	8
O. Vrána	-	-	-	-	-	-	-	9	-	-	-	9
F. Závřel	-	-	-	-	-	-	-	-	3	-	-	3
M. Zbožínek	-	-	10	5	-	-	11	9	-	-	-	35
V. Zemín	-	-	-	-	-	-	-	-	-	-	8	8
V. Zlochová	-	-	-	-	-	-	-	-	-	28	-	28
J. Žára	-	-	-	-	-	-	3	-	-	-	-	3
Z. Židek	12	14	12	8	-	1	4	-	-	-	-	51
M. Živný	7	3	-	2	-	2	5	-	-	13	4	36

Regionální soutěže 2018
Regional Competitions 2018

muži / seniors

U15

U13

U11+U10

U9+U8

U7+U6

Severozápad / Northwest

- 1 Old Boys Praha
- 2 Rakovník Red Crayfish
- 3 Fulleros de la Habana
- 4 SaBaT Praha B
- 5 Miners Kladno
- 5 Tempo Titans B
- 7 Kotlářka Praha B
- 8 Céčko Praha

- 1 Tempo Titans
- 2 Eagles Praha
- 3 SaBaT Praha
- 4 Kotlářka Praha
- 5 Miners Kladno
- 6 Sokol Hluboká
- 7 Wolfs Domažlice
- 8 Rakovník Red Crayfish
- 9 Lokomotiva Louny

- 1 SK Kotlářka Praha
- 2 Eagles Praha Green
- 3 Eagles Praha White
- 4 Tempo Titans Praha
- 5 SK Kotlářka Praha B
- 6 Miners Kladno
- 7 SaBaT Praha
- 8 Baseball Plzeň

- 1 SK Kotlářka Praha
- 2 SaBaT Praha
- 3 Miners Kladno
- 4 Tempo Titans White
- 5 Tempo Titans Blue
- 6 Eagles Praha

U11

- 1 Joudrs Praha
- 2 Miners Kladno
- 3 Piranhas Beroun
- 4 Rakovník Red Crayfish
- 5 Praotci Roudnice

U11

- 1 Tempo Titans Praha
- 2 Eagles Praha White
- 3 Eagles Praha Green
- 4 Kotlářka Praha

U10

- 1 Kotlářka Praha
- 2 Eagles Praha
- 3 Tempo Titans Praha
- 4 SaBaT Praha

U8

- Eagles Praha
- Miners Kladno
- Piranhas Beroun
- SaBaT Praha

U8

- 1 Tempo Titans White
- 2 Tempo Titans Blue
- 3 Kotlářka Praha
- 4 Eagles Praha White
- 5 Eagles Praha dívky
- 6 Eagles Praha Green
- 7 Tempo Titans U6
- 8 SaBaT Praha

- Eagles Praha U6
- Eagles Praha U7
- Miners Kladno Black
- Miners Kladno Green
- Piranhas Beroun
- Baseball Plzeň
- Tempo Titans Praha
- Tempo Titan U6
- Tempo Titans Blue
- Tempo Titans White

Jihozápad / Southwest

- 1 Sokol Hluboká
- 2 Wolfs Domažlice
- 3 Klatovy Brewers
- 4 Baseball Plzeň

U11

- 1 Baseball Plzeň
- 2 Pigs Trhové Sviny
- 3 Sokol Hluboká
- 4 SC Merklín
- 5 Sokol Hluboká B
- 6 Wolfs Domažlice

Severovýchod / Northeast

- Patriots Liberec
- North East

- 1 Blesk Jablonec
- 2 Waynes Pardubice
- 3 Rytíři Trutnov
- 4 Patriots Liberec
- 5 Orli Choceň Navy
- 6 Orli Choceň White

- 1 Blesk Jablonec
- 2 Rytíři Trutnov
- 3 Waynes Pardubice
- 4 Orli Choceň
- 5 Baryba Velký Osek

U11

- 1 Rytíři Trutnov
- 2 Orli Choceň
- 3 Baryba Velký Osek

U8

- 1 Klackaři Kostelec
- 2 Orli Choceň
- 3 Rytíři Trutnov
- 4 Blesk Jablonec
- 5 Baryba Velký Osek
- 6 Waynes Pardubice

- Orli Choceň Navy
- Klackaři Kostelec
- Orli Choceň White
- Blesk Jablonec
- NorthEast Stars

Regionální soutěže 2018
Regional Competitions 2018

muži / seniors

U15

U13

U11+U10

U9+U8

U7+U6

Jih / South

- 1 Olympia Blansko B
- 2 Draci Brno C
- 3 FOXES Brno
- 4 Technika Brno Reds
- 5 Moravská Beseda
- 6 Skokani Olomouc B
- 7 Nuclears Třebíč B
- 8 Ježci Jihlava
- 9 Fighting Flies Bratislava

- 1 Draci Brno
- 2 Hroši Brno
- 3 Nuclears Třebíč
- 4 STU Angels Trnava
- 5 Technika Brno
- 6 Outmen Skalica

- 1 Draci Brno White
- 2 Draci Brno Black
- 3 Hroši Brno
- 4 Nuclears Třebíč I.
- 5 Nuclears Třebíč
- 6 Hroši Brno B
- 7 Olympia Blansko
- 8 Outmen Skalica
- 9 Technika Brno
- 10 TJ STU Angels Trnava
- 11 Pelikans Bučovice

- 1 Hroši Brno
- 2 Draci Brno
- 3 Nuclears Třebíč
- 4 Olympia Blansko
- 5 Oilers Hodonín
- 6 Technika Brno

U11

- 1 Nuclears Třebíč
- 2 Draci Brno
- 3 Ježci Jihlava
- 4 Oilers Hodonín
- 5 Olympia Blansko
- 6 Hroši Brno
- 7 Ježci Jihlava Green

U10

- 1 Hroch Brno
- 2 Nuclears Třebíč
- 3 Pipas Brno
- 4 Draci Brno Black
- 5 Ježci Jihlava
- 6 Oilers Hodonín
- 7 Draci Brno White
- 8 Pelikans Bučovice

U8

- 1 Draci Brno Flames
- 2 Hroch Brno II
- 3 Pipas Brno
- 4 Olympia Blansko Blue
- 5 Technika Brno
- 6 Hroch Brno
- 7 Draci Brno Clutches
- 8 Ježci Jihlava Yellow
- 9 Oilers Hodonín
- 10 Olympia Blansko Yellow
- 11 Nuclears Třebíč I
- 12 Nuclears Třebíč II
- 13 Ježci Jihlava Green
- 14 Pelikans Bučovice

- 1 Pipas Brno
- 2 Nuclears Třebíč II
- 3 Hroch Brno
- 4 Draci Brno
- 5 Olympia Blansko
- 6 Nuclears Třebíč I.

U7

Východ / East

- 1 Arrows Ostrava
- 2 Klasik Frýdek-Místek
- 3 Skokani Olomouc

- 1 Klasik Frýdek-Místek
- 2 Arrows Ostrava
- 3 Skokani Olomouc
- 4 Silesia Rybnik
- 5 Cobblers Zlín
- 6 Rawa Katowice
- 7 Cannibals Šumperk

- 1 Klasik FM Whites
- 2 Arrows Ostrava
- 3 Klasik FM Reds
- 4 Skokani Olomouc

U11

- 1 Arrows Ostrava
- 2 Klasik Frýdek-Místek
- 3 Skokani Olomouc
- 4 HIT Opava

U8

- 1 Arrows Ostrava
- 2 Skokani Olomouc
- 3 Klasik Frýdek-Místek
- 4 HIT Opava
- 5 Cannibals Šumperk

- 1 Arrows Ostrava
- 2 Klasik Frýdek-Místek
- 3 Skokani Olomouc
- 4 HIT Opava
- 5 Cannibals Šumperk
- 6 Rawa Katowice

U10

Regionální přebor mužů Severozápad 2018
Northwest League Seniors 2018

	Fulleros	SaBaT B	Rakovník	Old Boys	Tempo B	Miners	Kotlářka B	Céčko	G	W	L	PCT
Fulleros		14 - 10 11 - 3	15 - 5 13 - 5	8 - 3 22 - 17	6 - 21 5 - 6	15 - 11 1 - 24	7 - 6 14 - 2	14 - 4 13 - 7	14	11	3	786
SaBaT B	10 - 14 3 - 11		15 - 2 4 - 21	1 - 23 14 - 7	16 - 11 10 - 8	11 - 10 7 - 4	23 - 6 13 - 2	19 - 7 11 - 12	14	9	5	643
Rakovník	5 - 15 5 - 13	2 - 15 21 - 4		8 - 2 18 - 19	5 - 4 9 - 5	8 - 15 10 - 5	4 - 8 11 - 2	17 - 2 13 - 6	14	8	6	571
Old Boys	3 - 8 17 - 22	23 - 1 7 - 14	2 - 8 19 - 18		6 - 3 3 - 13	8 - 11 9 - 2	9 - 8 23 - 14	10 - 7 19 - 14	14	7	7	500
Tempo B	21 - 6 6 - 5	11 - 16 8 - 10	4 - 5 5 - 9	3 - 6 13 - 3		14 - 5 13 - 14	9 - 5 0 - 4	14 - 1 11 - 1	14	7	7	500
Miners Kladno	11 - 15 24 - 1	10 - 11 4 - 7	15 - 8 5 - 10	11 - 8 2 - 9	5 - 14 14 - 13		2 - 12 10 - 4	8 - 14 9 - 0	14	6	8	429
Kotlářka B	6 - 7 2 - 14	6 - 23 2 - 13	8 - 4 2 - 11	8 - 9 14 - 23	5 - 9 4 - 0	12 - 2 4 - 10		10 - 14 21 - 8	14	4	10	286
Céčko Praha	4 - 14 7 - 13	7 - 19 12 - 11	2 - 17 6 - 13	7 - 10 14 - 19	1 - 14 1 - 11	14 - 8 0 - 9	14 - 10 8 - 21		14	3	11	214

Play-off

Tempo B - Céčko	19 - 9	14 - 2	
Miners - Kotlářka B	4 - 6	18 - 8	11 - 10
Old Boys - Fulleros	6 - 5	12 - 11	
SaBaT B - Rakovník	9 - 18	7 - 13	
o 7. místo / for 7th place			
Kotlářka B - Céčko	21 - 4		
o 5. místo / for 5th place			
Tempo B - Miners	2 - 4		
o 3. místo / for 3rd place			
Fulleros - SaBaT	12 - 2		
finále / final			
Old Boys - Red Crayfish	7 - 8	17 - 5	12 - 8

Regionální přebor U15 Severozápad 2018

Northwest U15 League 2018

	Eagles	Tempo	SaBaT W	SaBaT R	Hluboká	Wolfs	Miners	Kotlářka	Rakovník	Louny	G	W	L	PCT
Eagles		6 - 2 5 - 1	18 - 1 12 - 3	12 - 5 14 - 2	6 - 0 7 - 2	13 - 6 15 - 3	11 - 10 16 - 3	18 - 3 21 - 9	12 - 1 14 - 4	8 - 2 11 - 6	18	18	0	1000
Tempo	2 - 6 1 - 5		8 - 5 13 - 14	8 - 7 5 - 9	9 - 10 8 - 5	12 - 3 21 - 2	8 - 5 8 - 1	11 - 8 15 - 3	7 - 2 2 - 1	14 - 4 12 - 1	18	13	5	722,2
SaBaT White	1 - 18 3 - 12	5 - 8 14 - 13		9 - 13 7 - 6	6 - 5 12 - 5	6 - 4 5 - 2	5 - 3 6 - 7	8 - 7 6 - 3	20 - 8 14 - 7	13 - 1 6 - 1	18	13	5	722,2
SaBaT Red	5 - 12 2 - 14	7 - 8 9 - 5	13 - 9 6 - 7		3 - 13 6 - 5	12 - 4 7 - 12	22 - 2 14 - 8	10 - 6 18 - 14	18 - 3 11 - 1	18 - 6 18 - 0	18	12	6	666,7
Hluboká	0 - 6 2 - 7	10 - 9 5 - 8	5 - 6 5 - 12	13 - 3 5 - 6		3 - 7 16 - 4	8 - 4 7 - 9	15 - 13 7 - 1	7 - 0 7 - 0	7 - 0 7 - 0	18	10	8	555,6
Wolfs	6 - 13 3 - 15	3 - 12 2 - 21	4 - 6 2 - 5	4 - 12 12 - 7	7 - 3 4 - 16		4 - 5 7 - 3	7 - 1 13 - 9	zrušeno	9 - 2 16 - 3	16	7	9	437,5
Miners	10 - 11 3 - 16	5 - 8 1 - 8	3 - 5 7 - 6	2 - 22 8 - 14	4 - 8 9 - 7	5 - 4 3 - 7		9 - 8 24 - 6	8 - 2 9 - 4	15 - 1 9 - 0	18	9	9	500
Kotlářka	3 - 18 9 - 21	8 - 11 3 - 15	7 - 8 3 - 6	6 - 10 14 - 18	13 - 15 1 - 7	1 - 7 9 - 13	8 - 9 6 - 24		12 - 7 18 - 3	17 - 5 16 - 14	18	4	14	222,2
Rakovník	1 - 12 4 - 14	2 - 7 1 - 2	8 - 20 7 - 14	3 - 18 1 - 11	0 - 7 0 - 7	cancelled	2 - 8 4 - 9	7 - 12 3 - 18		8 - 9 14 - 11	16	1	15	62,5
Louny	2 - 8 6 - 11	4 - 14 1 - 12	1 - 13 1 - 6	6 - 18 0 - 18	0 - 7 0 - 7	2 - 9 3 - 16	1 - 15 0 - 9	5 - 17 14 - 16	9 - 8 11 - 14		18	1	17	55,56

	Tempo	Eagles	SaBaT	Kotlářka	Miners	G	W	L	PCT
Tempo Titans		13 - 5	8 - 2	13 - 7	13 - 10	4	4	0	1000
Eagles Praha	5 - 13		15 - 6	15 - 2	3 - 5	4	2	2	500
SaBaT White	2 - 8	6 - 15		11 - 6	7 - 6	4	2	2	500
Kotlářka Praha	7 - 13	2 - 15	6 - 11		8 - 7	4	1	3	250
Miners Kladno	10 - 13	5 - 3	6 - 7	7 - 8		4	1	3	250

Regionální přebor U13 Severozápad 2018
Northwest U13 League 2018

	SK	Eagles G	Eagles W	Tempo	SK B	Miners	SaBaT	Plzeň	G	W	L	D	PCT
SK Kotlářka		4 - 3	7 - 4	17 - 6	11 - 5	17 - 8	14 - 4	20 - 5	21	20	1	0	952
		4 - 11	7 - 4	21 - 5	7 - 5	10 - 4	29 - 1	20 - 2					
		10 - 3	16 - 5	9 - 7	11 - 3	16 - 9	14 - 2	25 - 3					
Eagles Green	3 - 4		11 - 10	16 - 1	13 - 2	8 - 7	16 - 3	13 - 3	21	19	2	0	905
	11 - 4		12 - 6	4 - 3	14 - 0	19 - 6	16 - 1	16 - 1					
	3 - 10		8 - 3	18 - 0	4 - 3	17 - 5	11 - 1	26 - 4					
Eagles White	4 - 7	10 - 11		4 - 7	7 - 4	17 - 13	15 - 5	9 - 2	21	12	9	0	571
	4 - 7	6 - 12		3 - 20	7 - 4	4 - 11	12 - 7	17 - 5					
	5 - 16	3 - 8		14 - 3	7 - 4	15 - 10	16 - 7	15 - 8					
Tempo Titans	6 - 17	1 - 16	7 - 4		5 - 9	10 - 4	16 - 4	13 - 1	21	10	10	1	500
	5 - 21	3 - 4	20 - 3		9 - 4	8 - 7	9 - 8	8 - 7					
	7 - 9	0 - 18	3 - 14		12 - 13	6 - 6	20 - 4	7 - 8					
SK Kotlářka B	5 - 11	2 - 13	4 - 7	9 - 5		18 - 17	9 - 11	5 - 2	21	10	11	0	476
	5 - 7	0 - 14	4 - 7	4 - 9		9 - 8	24 - 10	10 - 7					
	3 - 11	3 - 4	4 - 7	13 - 12		10 - 6	10 - 6	14 - 13					
Miners	8 - 17	7 - 8	13 - 17	4 - 10	17 - 18		12 - 17	14 - 3	21	5	15	1	262
	4 - 10	6 - 19	11 - 4	7 - 8	8 - 9		2 - 9	12 - 5					
	9 - 16	5 - 17	10 - 15	6 - 6	6 - 10		10 - 1	24 - 7					
SaBaT	4 - 14	3 - 16	5 - 15	4 - 16	11 - 9	17 - 12		4 - 12	21	5	16	0	238
	1 - 29	1 - 16	7 - 12	8 - 9	10 - 24	9 - 2		7 - 4					
	2 - 14	1 - 11	7 - 16	4 - 20	6 - 10	1 - 10		17 - 1					
Plzeň	5 - 20	3 - 13	2 - 9	1 - 13	2 - 5	3 - 14	12 - 4		21	2	19	0	095
	2 - 20	1 - 16	5 - 17	7 - 8	7 - 10	5 - 12	4 - 7						
	3 - 25	4 - 26	8 - 15	8 - 7	13 - 14	7 - 24	1 - 17						

Regionální přebor U11 Severozápad 2018
Northwest U11 League 2018

	SK	SaBaT	Miners	Tempo W	Tempo B	Eagles	G	W	L	PCT
SK Kotlářka		9 - 8	13 - 12	15 - 20	7 - 8	13 - 8	15	10	5	667
		9 - 4	9 - 8	3 - 6	15 - 5	7 - 4				
		9 - 1	11 - 12	10 - 9	8 - 9	15 - 6				
SaBaT Praha	8 - 9		10 - 2	11 - 8	3 - 13	1 - 9	15	8	7	533
	4 - 9		7 - 1	8 - 6	10 - 17	4 - 5				
	1 - 9		4 - 3	9 - 8	2 - 1	14 - 9				
Miners Kladno	12 - 13	2 - 10		11 - 6	1 - 15	7 - 3	15	7	8	467
	8 - 9	1 - 7		2 - 1	13 - 5	6 - 14				
	12 - 11	3 - 4		7 - 8	7 - 5	12 - 8				
Tempo White	20 - 15	8 - 11	6 - 11		5 - 9	10 - 8	15	7	8	467
	6 - 3	6 - 8	1 - 2		5 - 4	9 - 4				
	9 - 10	8 - 9	8 - 7		10 - 8	9 - 10				
Tempo Blue	8 - 7	13 - 3	15 - 1	9 - 5		7 - 10	15	7	8	467
	5 - 15	17 - 10	5 - 13	4 - 5		8 - 13				
	9 - 8	1 - 2	5 - 7	8 - 10		14 - 10				
Eagles Praha	8 - 13	9 - 1	3 - 7	8 - 10	10 - 7		15	6	9	400
	4 - 7	5 - 4	14 - 6	4 - 9	13 - 8					
	6 - 15	9 - 14	8 - 12	10 - 9	10 - 14					

Regionální přebor U11 Středočeský 2018
Centralwest U11 League 2018

	Joudrs	Miners	Piranhas	Crayfish	Praotci	G	W	L	PCT
Joudrs Praha		6 - 10	9 - 5	0 - 7	20 - 4	8	6	2	875
		8 - 3	14 - 10	18 - 4	15 - 7				
Miners Kladno	10 - 6		2 - 15	11 - 10	10 - 9	8	6	2	875
	3 - 8		13 - 11	18 - 6	16 - 4				
Piranhas Beroun	5 - 9	15 - 2		20 - 1	15 - 1	8	5	3	813
	10 - 14	11 - 13		19 - 4	7 - 2				
Red Crayfish	7 - 0	10 - 11	1 - 20		19 - 6	8	2	6	625
	4 - 18	6 - 18	4 - 19		0 - 7				
Praotci Roudnice	4 - 20	9 - 10	1 - 15	6 - 19		8	1	7	563
	7 - 15	4 - 16	2 - 7	7 - 0					

Regionální přebor U10 Severozápad 2018
Northwest League U10 2018

	Tempo	Eagles W	Eagles G	Kotlářka	G	W	L	PCT
Tempo Titans Praha		11 - 4	7 - 0	10 - 2	12	11	1	917
		3 - 4	9 - 3	6 - 0				
		5 - 1	21 - 3	13 - 0				
		12 - 7	11 - 9	8 - 1				
Eagles Praha White	4 - 11		12 - 1	9 - 5	12	7	5	583
	4 - 3		12 - 2	7 - 9				
	1 - 5		12 - 1	2 - 4				
	7 - 12		12 - 2	9 - 1				
Eagles Praha Green	0 - 7	1 - 12		13 - 12	12	4	8	333
	3 - 9	2 - 12		11 - 8				
	3 - 21	1 - 12		15 - 3				
	9 - 11	2 - 12		11 - 5				
Kotlářka Praha	2 - 10	5 - 9	12 - 13		12	2	10	167
	0 - 6	9 - 7	8 - 11					
	0 - 13	4 - 2	3 - 15					
	1 - 8	1 - 9	5 - 11					

Regionální přebor U8 Severozápad 2018
Northwest U8 League 2018

	Kotlářka	Eagles	Tempo	SaBaT	G	W	L	D	PCT
Kotlářka Praha		16 - 7	7 - 2	20 - 1	12	9	3	0	875
		14 - 2	9 - 11	20 - 1					
		5 - 7	1 - 9	19 - 0					
		11 - 4	9 - 1	15 - 11					
Eagles Praha	7 - 16		7 - 5	18 - 8	12	8	4	0	833
	2 - 14		3 - 9	15 - 13					
	7 - 5		20 - 10	20 - 2					
	4 - 11		18 - 7	15 - 14					
Tempo Titans	2 - 7	5 - 7		3 - 6	12	5	6	1	667
	11 - 9	9 - 3		7 - 4					
	9 - 1	10 - 20		20 - 20					
	1 - 9	7 - 18		10 - 7					
SaBaT Praha	1 - 20	8 - 18	6 - 3		12	1	10	1	500
	1 - 20	13 - 15	4 - 7						
	0 - 19	2 - 20	20 - 20						
	11 - 15	14 - 15	7 - 10						

Regionální přebor U8 Středočeský 2018
Central Bohemia U8 League 2018

Eagles Praha
Miners Kladno
Piranhas Beroun
SaBaT Praha

Soutěž se nehrála na výsledky
Results not available

Regionální přebor U7 Severozápad 2018
Northwest League U7 2018

	Tempo W	Tempo B	Kotlářka	Eagles W	Eagles d	Eagles G	Tempo U6	SaBaT	G	W	L	D	PCT
Tempo White		5 - 10	11 - 10	6 - 5	10 - 8	8 - 7	10 - 5	15 - 7	14	11	3	0	786
		2 - 10	10 - 15	13 - 8	10 - 9	5 - 4	13 - 7	15 - 5					
Tempo Blue	10 - 5		15 - 9	10 - 15	10 - 11	15 - 10	11 - 7	15 - 14	14	10	3	1	750
	10 - 2		13 - 9	14 - 6	15 - 15	15 - 12	9 - 4	10 - 19					
Kotlářka	10 - 11	9 - 15		0 - 1	5 - 4	1 - 0	14 - 15	13 - 4	14	7	7	0	500
	15 - 10	9 - 13		1 - 0	4 - 8	1 - 0	0 - 7	14 - 7					
Eagles White	5 - 6	15 - 10	1 - 0		4 - 6	8 - 5	9 - 7	14 - 13	14	7	7	0	500
	8 - 13	6 - 14	0 - 1		13 - 7	7 - 11	13 - 5	8 - 15					
Eagles dívky	8 - 10	11 - 10	4 - 5	6 - 4		9 - 11	6 - 7	8 - 11	14	6	7	1	464
	9 - 10	15 - 15	8 - 4	7 - 13		9 - 7	9 - 6	15 - 12					
Eagles Green	7 - 8	10 - 15	0 - 1	5 - 8	11 - 9		12 - 10	15 - 7	14	6	8	0	429
	4 - 5	12 - 15	0 - 1	11 - 7	7 - 9		10 - 6	10 - 4					
Tempo U6	5 - 10	7 - 11	15 - 14	7 - 9	7 - 6	10 - 12		10 - 7	14	4	10	0	286
	7 - 13	4 - 9	7 - 0	5 - 13	6 - 9	6 - 10		9 - 15					
SaBaT	7 - 15	14 - 15	4 - 13	13 - 14	11 - 8	7 - 15	7 - 10		13	3	10	0	231
	5 - 15	19 - 10	7 - 14	15 - 8	12 - 15	4 - 10	15 - 9						

Regionální přebor U7 Středočeský 2018
Central Bohemia U7 League 2018

Eagles Praha U6
Eagles Praha U7
Miners Kladno Black
Miners Kladno Green
Piranhas Beroun
Baseball Plzeň
Tempo Titans Praha
Tempo Titan Praha U6
Tempo Titans Praha Blue
Tempo Titans Praha White

Soutěž se nehrála na výsledky

Results not available

Regionální přebor U11 Jihozápad 2018
Southwest League U11 2018

	Hluboká	Plzeň	Wolfs	Plzeň B	Brewers	G	W	L	PCT
Sokol Hluboká		17 - 1	8 - 4	15 - 5	15 - 3	16	14	2	875
		3 - 7	13 - 0	10 - 8	13 - 2				
		6 - 0	12 - 6	8 - 6	16 - 2				
		15 - 1	7 - 5	7 - 9	15 - 2				
Baseball Plzeň	1 - 17		4 - 10	16 - 10	9 - 7	16	11	5	688
	7 - 3		14 - 3	14 - 11	16 - 14				
	0 - 6		5 - 11	12 - 9	16 - 9				
	1 - 15		10 - 8	12 - 8	20 - 8				
Wolfs Domažlice	4 - 8	10 - 4		15 - 5	13 - 7	16	9	7	563
	0 - 13	3 - 14		8 - 4	12 - 1				
	6 - 12	11 - 5		15 - 6	3 - 4				
	5 - 7	8 - 10		5 - 1	13 - 3				
Baseball Plzeň B	5 - 15	10 - 16	5 - 15		13 - 10	16	3	13	188
	8 - 10	11 - 14	4 - 8		7 - 12				
	6 - 8	9 - 12	6 - 15		24 - 13				
	9 - 7	8 - 12	1 - 5		7 - 8				
Brewers Klatovy	3 - 15	7 - 9	7 - 13	10 - 13		16	3	13	188
	2 - 13	14 - 16	1 - 12	12 - 7					
	2 - 16	9 - 16	4 - 3	13 - 24					
	2 - 15	8 - 20	3 - 13	8 - 7					

semifinále / semi finals

Sokol Hluboká - Klatovy Brewers 10 - 1

Baseball Plzeň - Wolfs Domažlice 8 - 10

o 3. místo / for 3rd place

Klatovy Brewer - Baseball Plzeň 6 - 5

finále / final

Sokol Hluboká - Wolfs Domažlice 14 - 0

Regionální přebor U7 Jihozápad 2018
Southwest U7 League 2018

	Plzeň	Merklín	Wolfs	G	W	L	PCT
Baseball Plzeň		15 - 0	10 - 5	8	8	0	1000
		15 - 5	15 - 7				
		10 - 8	14 - 3				
		15 - 5	10 - 6				
SC Merklín	0 - 15		12 - 11	8	4	4	500
	5 - 15		9 - 0				
	8 - 10		10 - 6				
	5 - 15		14 - 3				
Wolfs Domažlice	5 - 10	11 - 12		8	0	8	000
	7 - 15	0 - 9					
	3 - 14	6 - 10					
	6 - 10	3 - 14					

	Sviny	Hluboká B	Hluboká	G	W	L	PCT
Pigs Trhové Sviny		10 - 2	5 - 4	4	3	1	750
		5 - 10	15 - 7				
Sokol Hluboká B	2 - 10		15 - 14	4	2	2	500
	10 - 5		9 - 10				
Sokol Hluboká	4 - 5	14 - 15		4	1	3	250
	7 - 15	10 - 9					

	Sviny	Plzeň	Merklín	Hluboká	Hluboká B	Wolfs	G	W	L	D	PCT
Pigs T. Sviny		13 - 12	15 - 4	15 - 4	15 - 0	12 - 7	7	7	0	0	1000
				5 - 4	10 - 2						
Baseball Plzeň	12 - 13		12 - 8	15 - 1	15 - 5	15 - 7	9	8	1	0	889
			12 - 10			10 - 6					
			15 - 4			15 - 1					
SC Merklín	4 - 15	8 - 12		6 - 10	10 - 8	15 - 10	9	3	5	1	389
		10 - 12				10 - 1					
		4 - 15				6 - 6					
Sokol Hluboká	4 - 15	1 - 15	10 - 6		14 - 15	14 - 9	6	2	4	0	333
	4 - 5										
Sokol Hluboká B	0 - 15	5 - 15	8 - 10	15 - 14		13 - 8	6	2	4	0	333
	2 - 10										
Wolfs Domažlice	7 - 12	7 - 15	10 - 15	9 - 14	8 - 13		9	0	8	1	056
		6 - 10	1 - 10								
		1 - 15	6 - 6								

Regionální přebor U15 Severovýchod 2018
Northeast U15 League 2018

	Patriots	Rytíři	G	W	L	PCT
Patriots Liberec		15 - 18	6	3	3	500
		16 - 5				
		5 - 6				
		10 - 16				
		11 - 9				
		15 - 14				
North East Star	18 - 15		6	3	3	500
	5 - 16					
	6 - 5					
	16 - 10					
	9 - 11					
	14 - 15					

Regionální přebor U13 Severovýchod 2018
Northeast U13 League 2018

	Blesk	Waynes	Rytíři	Patriots	Orli N	Orli W	G	W	L	PCT
Blesk Jablonec		14 - 4	15 - 14	11 - 10	13 - 0	18 - 8	10	10	0	1000
		13 - 2	13 - 6	13 - 8	5 - 2	18 - 6				
Waynes Pardubice	4 - 14		6 - 4	6 - 5	11 - 9	12 - 11	10	8	2	800
	2 - 13		12 - 8	11 - 9	22 - 7	16 - 9				
Rytíři Trutnov	14 - 15	4 - 6		12 - 11	13 - 6	10 - 6	10	6	4	600
	6 - 13	8 - 12		12 - 6	19 - 11	11 - 6				
Patriots Liberec	10 - 11	5 - 6	11 - 12		9 - 10	7 - 4	10	3	7	300
	8 - 13	9 - 11	6 - 12		11 - 9	21 - 10				
Orli Choceň Navy	0 - 13	9 - 11	6 - 13	10 - 9		15 - 12	10	2	8	200
	2 - 5	7 - 22	11 - 19	9 - 11		13 - 14				
Orli Choceň White	8 - 18	11 - 12	6 - 10	4 - 7	12 - 15		10	1	9	100
	6 - 18	9 - 16	6 - 11	10 - 21	14 - 13					

O umístění

Patriots Liberec - Blesk Jablonec	7 - 9	6 - 10
Orli Choceň Navy - Patriots Liberec	12 - 14	14 - 18

Regionální přebor U11 Severovýchod 2018
Northeast U11 League 2018

	Blesk	Rytíři	Waynes	Orli	Baryba	G	W	L	S	PCT
Blesk Jablonec		2 - 7	18 - 0	16 - 0	20 - 2	10	8	2	0	800
		10 - 3	14 - 6	19 - 1	23 - 0					
		7 - 8								
		13 - 1								
Rytíři Trutnov	7 - 2		20 - 6	22 - 0	20 - 0	10	8	2	0	800
	3 - 10		15 - 0	22 - 0	25 - 1					
	8 - 7									
	1 - 13									
Waynes Pardubice	0 - 18	6 - 20		9 - 7	9 - 0	10	5	5	0	500
	6 - 14	0 - 15		5 - 11	9 - 0					
				14 - 6	9 - 0					
Orli Choceň	0 - 16	0 - 22	7 - 9		9 - 0	10	4	6	0	400
	1 - 19	0 - 22	11 - 5		9 - 0					
			6 - 14		9 - 0					
Baryba V. Osek	2 - 20	0 - 20	0 - 9	0 - 9		10	0	4	6	000
	0 - 23	1 - 25	0 - 9	0 - 9						
			0 - 9	0 - 9						

Nadstavba

Waynes Pardubice - Rytíři Trutnov 0 - 13 3 - 12 1 - 13

Regionální přebor U8 Severovýchod 2018
Northeast U8 League 2018

	Rytíři	Orli	Baryba	G	W	L	S	PCT
Rytíři Trutnov		17 - 20	20 - 13	12	9	3	0	750
		18 - 13	20 - 6					
		15 - 14	18 - 16					
		14 - 20	15 - 5					
		14 - 15	9 - 0					
		19 - 8	9 - 0					
Orli Choceň	20 - 17		20 - 17	12	8	4	0	667
	13 - 18		15 - 6					
	14 - 15		20 - 14					
	20 - 14		11 - 14					
	15 - 14		9 - 0					
	8 - 19		9 - 0					
Baryba V. Osek	13 - 20	17 - 20		12	1	7	4	083
	6 - 20	6 - 15						
	16 - 18	14 - 20						
	5 - 15	14 - 11						
	0 - 9	0 - 9						
	0 - 9	0 - 9						

Regionální přebor U7 Severovýchod 2018
Northeast U7 League 2018

	Klackaři	Orli	Rytíři	Blesk	Baryba	Waynes	G	W	L	D	S	PCT
Klackaři Kostelec		8 - 2	9 - 0	15 - 0	9 - 0	9 - 0	10	9	1	0	0	900
		3 - 2	9 - 12	15 - 0	9 - 0	7 - 6						
Orli Choceň	2 - 8		11 - 1	9 - 11	13 - 9	3 - 3	10	6	3	1	0	650
	2 - 3		9 - 0	15 - 6	9 - 0	9 - 0						
Rytíři Trutnov	0 - 9	1 - 11		13 - 12	9 - 0	9 - 0	10	6	1	0	3	600
	12 - 9	0 - 9		15 - 3	0 - 0	9 - 0						
Blesk Jablonec	0 - 15	11 - 9	12 - 13		9 - 9	7 - 8	10	3	6	1	0	350
	0 - 15	6 - 15	3 - 15		9 - 0	9 - 0						
Baryba V. Osek	0 - 9	9 - 13	0 - 9	9 - 9		9 - 0	10	1	1	1	7	150
	0 - 9	0 - 9	0 - 0	0 - 9		0 - 0						
Waynes Pardubice	0 - 9	3 - 3	0 - 9	8 - 7	0 - 9		10	1	1	1	7	150
	6 - 7	0 - 9	0 - 9	0 - 9	0 - 0							

Regionální přebor U6 Severovýchod 2018
Northeast U6 League 2018

	Klackaři	Blesk	Stars	Orli N	Orli W	G	W	L	D	S	PCT
Klackaři Kostelec		8 - 9	5 - 2	8 - 4	7 - 1	7	5	1	1	0	786
		12 - 4	8 - 8	10 - 6							
Blesk Jablonec	9 - 8		6 - 4	8 - 8	10 - 6	7	4	1	2	0	714
	4 - 12		12 - 5	8 - 8							
NorthEast Stars	2 - 5	4 - 6		5 - 8	5 - 5	7	2	3	2	0	429
	8 - 8	5 - 12		8 - 5							
Orli Choceň Navy	4 - 8	8 - 8	8 - 5		8 - 8	7	1	3	3	0	357
	6 - 10	8 - 8	5 - 8								
Orli Choceň White	1 - 7	6 - 10	5 - 5	8 - 8		4	0	2	2	0	250

Regionální přebor mužů Jih 2018
South mens League 2018

	Olympia B	Technika	Draci C	FOXES	Beseda	Nuclears B	Skokani B	Fighting	Ježci	G	W	L	S	PCT
Olympia Blansko B		8 - 6	9 - 6	5 - 12	19 - 9	19 - 7	24 - 21	9 - 2	16 - 1	8	7	1	0	875
Technika Brno Reds	6 - 8		10 - 9	7 - 3	11 - 1	9 - 0	12 - 6	6 - 5	17 - 7	8	7	1	0	875
Draci Brno C	6 - 9	9 - 10		6 - 5	17 - 2	14 - 0	13 - 3	22 - 8	21 - 11	8	6	2	0	750
FOXES Brno	12 - 5	3 - 7	5 - 6		12 - 2	7 - 6	11 - 9	10 - 0	15 - 2	8	6	2	0	750
Moravská Beseda	9 - 19	1 - 11	2 - 17	2 - 12		16 - 13	15 - 4	19 - 9	20 - 5	8	4	4	0	500
Nuclears Třebíč B	7 - 19	0 - 9	0 - 14	6 - 7	13 - 16		10 - 5	8 - 7	16 - 1	8	3	4	1	375
Skokani Olomouc B	21 - 24	6 - 12	3 - 13	9 - 11	4 - 15	5 - 10		6 - 3	9 - 5	8	2	6	0	250
Fighting Flies	2 - 9	5 - 6	8 - 22	0 - 10	9 - 19	7 - 8	3 - 6		1 - 0	8	1	7	0	125
Ježci Jihlava	1 - 16	7 - 17	11 - 21	2 - 15	5 - 20	1 - 16	5 - 9	0 - 1		8	0	7	1	000

o 5.-8. místo / for 5th-8th place

Moravská Beseda - Ježci Jihlava

16 - 1

Nuclears třebíč B - Skokani Olomouc B

3 - 6

semifinále / semi finals

Olympia Blansko B - FOXES Brno

15 - 0

Technika Reds - Draci Brno C

7 - 20

o 3. místo / for 3rd place

Technika Brno Reds - FOXES Brno

9 - 14

finále / final

Olympia Blansko B - Draci Brno C

6 - 5

o 7. místo / for 7th place

Nuclears Třebíč B - Ježci Jihlava

24 - 12

o 5. místo / for 5th place

Moravská Beseda - Skokani Olomouc B

7 - 5

Regionální přebor U15 Jih 2018
South U15 League 2018

	Draci	Hroši	Nuclears	Trnava	Technika	Skalica	G	W	L	S	PCT
Draci Brno		4 - 2	14 - 3	25 - 4	7 - 0	10 - 1	20	19	1	0	950
		15 - 7	13 - 2	16 - 0	7 - 0	10 - 0					
		10 - 11	17 - 2	16 - 9	19 - 0	10 - 0					
		12 - 0	10 - 6	26 - 0	14 - 0	13 - 0					
Hroši Brno	2 - 4		17 - 3	17 - 3	8 - 7	13 - 1	20	16	4	0	800
	7 - 15		13 - 4	7 - 1	14 - 0	25 - 2					
	11 - 10		9 - 10	20 - 3	16 - 9	38 - 5					
	0 - 12		12 - 8	7 - 6	19 - 10	24 - 5					
Nuclears Třebíč	3 - 14	3 - 17		20 - 3	15 - 0	12 - 3	20	12	8	0	600
	2 - 13	4 - 13		10 - 11	15 - 6	11 - 2					
	2 - 17	10 - 9		9 - 0	14 - 1	20 - 4					
	6 - 10	8 - 12		10 - 2	11 - 4	17 - 3					
STU Angels Trnava	4 - 25	3 - 17	3 - 20		7 - 0	7 - 0	20	8	12	0	400
	0 - 16	1 - 7	11 - 10		8 - 5	6 - 2					
	9 - 16	3 - 20	0 - 9		19 - 9	12 - 7					
	0 - 26	6 - 7	2 - 10		0 - 15	24 - 0					
Technika Brno	0 - 7	7 - 8	0 - 15	0 - 7		34 - 0	20	5	13	2	250
	0 - 7	0 - 14	6 - 15	5 - 8		19 - 6					
	0 - 19	9 - 16	1 - 14	9 - 19		15 - 0					
	0 - 14	10 - 19	4 - 11	15 - 0		18 - 2					
Outmen Skalica	1 - 10	1 - 13	3 - 12	0 - 7	0 - 34		20	0	20	0	000
	0 - 10	2 - 25	2 - 11	2 - 6	6 - 19						
	0 - 10	5 - 38	4 - 20	7 - 12	0 - 15						
	0 - 13	5 - 24	3 - 17	0 - 24	2 - 18						

Nadstavba / post season

	Draci	Hroši	Nuclears	G	W	L	S	PCT
Draci Brno		9 - 4	15 - 2	6	4	2	0	667
		6 - 15	11 - 4					
		11 - 0	3 - 4					
Hroši Brno	4 - 9		8 - 0	6	4	2	0	667
	15 - 6		19 - 4					
	0 - 11		21 - 2					
Nuclears Třebíč	2 - 15	0 - 8		6	1	5	0	167
	4 - 11	4 - 19						
	4 - 3	2 - 21						

Regionální přebor U13 Jih 2018
South U13 League 2018

	Draci W	Draci B	Hroši	Nuclears I	Nuclears	Hroši B	Olympia	Skalica	Technika	Trnava	Bučovice	G	W	L	PCT
Draci White		6 - 5 4 - 3	7 - 4 12 - 2	7 - 6 10 - 4		14 - 2 15 - 10		16 - 1 22 - 1		14 - 2 12 - 0	15 - 0 18 - 0	14	14	0	1000
Draci Black	5 - 6 3 - 4		16 - 6 14 - 9	14 - 6 8 - 10	12 - 5 12 - 7		11 - 12 18 - 7		16 - 6 22 - 3			12	8	4	667
Hroši Brno	4 - 7 2 - 12	6 - 16 9 - 14			24 - 9 9 - 5	5 - 3 7 - 4	19 - 4 12 - 9		12 - 9 19 - 3			12	8	4	667
Nuclears I.	6 - 7 4 - 10	6 - 14 10 - 8			14 - 13 9 - 11	12 - 2 15 - 3		31 - 4 8 - 1		15 - 0 21 - 7	20 - 5 25 - 3	14	10	4	714
Nuclears		5 - 12 7 - 12	9 - 24 5 - 9	13 - 14 11 - 9		10 - 6 6 - 5	16 - 15 8 - 5		15 - 3 15 - 0			12	7	5	583
Hroši Brno B	2 - 14 10 - 15		3 - 5 4 - 7	2 - 13 3 - 15	6 - 10 5 - 6			12 - 7 17 - 18		17 - 3 21 - 4	26 - 1 16 - 8	14	5	9	357
Olympia Blansko		12 - 11 7 - 18	4 - 19 9 - 12		15 - 16 5 - 8							6	1	5	167
Outmen Skalica	1 - 16 1 - 22			4 - 31 1 - 8		7 - 12 18 - 17				3 - 16 13 - 2	12 - 11 24 - 4	10	4	6	400
Technika Brno		6 - 16 3 - 22	9 - 12 3 - 19		3 - 15 0 - 15							6	0	6	000
Angels Trnava	2 - 14 0 - 12			0 - 15 7 - 21		3 - 17 4 - 21		16 - 3 2 - 13				8	1	7	125
Pelikans Buč.	0 - 15 0 - 18			5 - 20 3 - 25		1 - 26 8 - 16		11 - 12 4 - 24				8	0	8	000

Outmen Skalica - Pelikans Bučovice 18 - 1 7 - 2

Draci Brno Black - Draci Brno White 3 - 4 5 - 6

Regionální přebor U11 Jih 2018
South U11 League 2018

	Draci	Hroši	Nuclears	Olympia	Technika	Oilers	G	W	L	S	PCT
Draci Brno		6 - 9	9 - 7	4 - 11	15 - 14	13 - 1	10	8	2	0	800
		21 - 2	12 - 2	16 - 1	20 - 0	8 - 6					
Hroši Brno	9 - 6		17 - 7	18 - 17	27 - 3	16 - 12	10	8	2	0	800
	2 - 21		14 - 1	6 - 8	15 - 6	18 - 5					
Nuclears Třebíč	7 - 9	7 - 17		6 - 5	21 - 6	12 - 9	10	6	4	0	600
	2 - 12	1 - 14		8 - 3	14 - 2	11 - 2					
Olympia Blansko	11 - 4	17 - 18	5 - 6		29 - 3	10 - 3	10	6	4	0	600
	1 - 16	8 - 6	3 - 8		26 - 8	20 - 4					
Technika Brno	14 - 15	3 - 27	6 - 21	3 - 29		17 - 6	10	1	9	0	100
	0 - 20	6 - 15	2 - 14	8 - 26		6 - 12					
Oilers Hodonín	1 - 13	12 - 16	9 - 12	3 - 10	6 - 17		10	1	9	0	100
	6 - 8	5 - 18	2 - 11	4 - 20	12 - 6						

semifinále / semi finals

Draci Brno - Olympia Blansko 14 - 1

Hroši Brno - Nuclears Třebíč 6 - 3

o 5. místo / for 5th place

Technika Brno - Oilers Hodonín 6 - 10 8 - 24

o 3. místo / for 3rd place

Nuclears Třebíč - Olympia Blansko 0 - 0

finále / final

Draci Brno - Hroši Brno 10 - 19 0 - 10

Regionální přebor U10 Jih 2018
South U10 League 2018

	Nuclears	Draci	Oilers	Ježci	Olympia	Hroši	Ježci G	G	W	L	PCT
Nuclears Třebíč		0 - 8	14 - 2	12 - 0	7 - 1	4 - 3	22 - 0	15	13	2	867
		4 - 9		14 - 0	8 - 1	5 - 2					
				18 - 2	15 - 0	7 - 1					
				8 - 1		16 - 7					
Draci Brno	8 - 0			16 - 1	2 - 3	5 - 4		8	7	1	875
	9 - 4			10 - 1	6 - 0	2 - 0					
Oilers Hodonín	2 - 14			9 - 6	3 - 7	9 - 4		7	3	4	429
				4 - 5	6 - 9	6 - 5					
Ježci Jihlava	0 - 12	1 - 16	6 - 9		4 - 3	9 - 4	8 - 0	14	6	8	429
	0 - 14	1 - 10	5 - 4		5 - 2	8 - 7					
	2 - 18					1 - 5					
	1 - 8										
Olympia Blansko	1 - 7	3 - 2	7 - 3	3 - 4		1 - 5		12	4	8	333
	1 - 8	0 - 6	9 - 6	2 - 5		4 - 1					
	0 - 15					9 - 11					
Hroši Brno	3 - 4	4 - 5	4 - 9	4 - 9	5 - 1		11 - 3	15	4	11	267
	2 - 5	0 - 2	5 - 6	7 - 8	1 - 4						
	1 - 7			5 - 1	11 - 9						
	7 - 16										
Ježci Jihlava Green	0 - 22			0 - 8		3 - 11		3	0	3	000

Regionální přebor U8 Jih 2018
South U8 League 2018

	Hroch	Nuclears	Pipas	Draci BI	Olympia	Ježci	Oilers	Draci W	Bučovice	G	W	L	PCT
Hroch z.s.		20 - 7	18 - 10	15 - 14	13 - 7	25 - 9	15 - 5	25 - 13	18 - 7	16	14	2	875
		15 - 10	18 - 9	13 - 14	5 - 11	23 - 13	19 - 1	20 - 6	21 - 10				
Nuclears Třebíč	7 - 20		16 - 8	11 - 22	13 - 4	16 - 6	20 - 14	20 - 9	17 - 6	16	13	3	813
	10 - 15		16 - 9	24 - 17	14 - 7	15 - 7	23 - 16	22 - 19	18 - 15				
Pipas Brno	10 - 18	8 - 16		17 - 16	18 - 17	15 - 10	17 - 15	11 - 7	18 - 5	16	12	4	750
	9 - 18	9 - 16		16 - 10	17 - 15	19 - 10	20 - 17	20 - 10	18 - 5				
Draci Brno Black	14 - 15	22 - 11	16 - 17		22 - 11	16 - 15	17 - 16	10 - 18	22 - 6	16	11	5	688
	14 - 13	17 - 24	10 - 16		20 - 14	25 - 11	14 - 10	20 - 15	21 - 2				
Olympia Blansko	7 - 13	4 - 13	17 - 18	11 - 22		13 - 10	20 - 9	17 - 9	19 - 5	16	9	7	563
	11 - 5	7 - 14	15 - 17	14 - 20		18 - 5	22 - 7	20 - 3	25 - 7				
Ježci Jihlava	9 - 25	6 - 16	10 - 15	15 - 16	10 - 13		20 - 13	11 - 19	13 - 10	16	5	11	313
	13 - 23	7 - 15	10 - 19	11 - 25	5 - 18		22 - 19	14 - 17	20 - 15				
Oilers Hodonín	5 - 15	14 - 20	15 - 17	16 - 17	9 - 20	13 - 20		19 - 14	8 - 4	16	4	12	250
	1 - 19	16 - 23	17 - 20	10 - 14	7 - 22	19 - 22		20 - 10	11 - 7				
Draci Brno White	13 - 25	9 - 20	7 - 11	18 - 10	9 - 17	19 - 11	14 - 19		12 - 14	16	2	14	125
	6 - 20	19 - 22	10 - 20	15 - 20	3 - 20	17 - 14	10 - 20		12 - 13				
Pelikans Bučovice	7 - 18	6 - 17	5 - 18	6 - 22	5 - 19	10 - 13	4 - 8	14 - 12		16	2	14	125
	10 - 21	15 - 18	5 - 18	2 - 21	7 - 25	15 - 20	7 - 11	13 - 12					

Regionální přebor U7 Jih 2018
South U7 League 2018

	Draci F	Hroch II	Pipas	Olympia B	Technika	Hroch I	Draci CI	Ježci Y	Oilers	Olympia Y	Nuclears I	Nuclears II	Ježci G	Pelikans	G	W	L	S	D	PCT
Draci Brno Flames		5 - 8	11 - 7	15 - 2	13 - 6	14 - 2	15 - 2	15 - 4	4 - 0	15 - 2	14 - 1	15 - 1	8 - 0	15 - 2	13	12	1	0	0	923
Hroch Brno II	8 - 5		9 - 15	12 - 11	9 - 1	15 - 4	15 - 1	10 - 5	9 - 0	15 - 3	13 - 2	15 - 8	12 - 3	15 - 2	13	12	1	0	0	923
Pipas Brno	7 - 11	15 - 9		7 - 2	12 - 9	13 - 5	5 - 1	7 - 2	9 - 0	7 - 6	9 - 3	12 - 1	15 - 2	15 - 0	13	12	1	0	0	923
Olympia Blue	2 - 15	11 - 12	2 - 7		5 - 4	10 - 6	8 - 8	9 - 4	11 - 9	9 - 8	13 - 6	8 - 5	6 - 7	10 - 0	13	8	4	0	1	654
Technika Brno	6 - 13	1 - 9	9 - 12	4 - 5		3 - 6	11 - 1	7 - 5	9 - 0	10 - 6	13 - 4	9 - 1	16 - 6	13 - 0	13	8	5	0	0	615
Hroch Brno I	2 - 14	4 - 15	5 - 13	6 - 10	6 - 3		15 - 9	2 - 7	8 - 15	8 - 6	11 - 6	17 - 3	15 - 3	9 - 3	13	7	6	0	0	538
Draci Brno Clutches	2 - 15	1 - 15	1 - 5	8 - 8	1 - 11	9 - 15		3 - 9	6 - 6	14 - 9	9 - 7	11 - 3	10 - 5	10 - 2	13	5	6	0	2	462
Ježci Jihlava Yellow	4 - 15	5 - 10	2 - 7	4 - 9	5 - 7	7 - 2	9 - 3		9 - 0	5 - 10	9 - 10	11 - 6	12 - 7	15 - 2	13	6	7	0	0	462
Oilers Hodonín	0 - 4	0 - 9	0 - 9	9 - 11	0 - 9	15 - 8	6 - 6	0 - 9		15 - 4	9 - 5	15 - 3	12 - 1	15 - 0	13	5	3	4	1	423
Olympia Yellow	2 - 15	3 - 15	6 - 7	8 - 9	6 - 10	6 - 8	9 - 14	10 - 5	4 - 15		13 - 8	15 - 9	13 - 11	15 - 0	13	5	8	0	0	385
Nuclears Třebíč I	1 - 14	2 - 13	3 - 9	6 - 13	4 - 13	6 - 11	7 - 9	10 - 9	5 - 9	8 - 13		11 - 5	15 - 6	10 - 2	13	4	9	0	0	308
Nuclears Třebíč II	1 - 15	8 - 15	1 - 12	5 - 8	1 - 9	3 - 17	3 - 11	6 - 11	3 - 15	9 - 15	5 - 11		15 - 7	15 - 1	13	2	11	0	0	154
Ježci Jihlava Green	0 - 8	3 - 12	2 - 15	7 - 6	6 - 16	3 - 15	5 - 10	7 - 12	1 - 12	11 - 13	6 - 15	7 - 15		10 - 4	13	2	11	0	0	154
Pelikans Bučovice	2 - 15	2 - 15	0 - 15	0 - 10	0 - 13	3 - 9	2 - 10	2 - 15	0 - 15	0 - 15	2 - 10	1 - 15	4 - 10		13	0	13	0	0	000

Regionální přebor U6 Jih 2018
South U6 League 2018

	Pipas	Nuclears II	Hroch	Draci	Olympia	Nuclears I	G	W	L	S	D	PCT
Pipas Brno		15 - 6	20 - 3	8 - 10	8 - 7	15 - 4	5	4	1	0	0	800
Nuclears Třebíč II	6 - 15		15 - 11	9 - 4	6 - 4	20 - 1	5	4	1	0	0	800
Hroch	3 - 20	11 - 15		13 - 11	10 - 7	15 - 8	5	3	2	0	0	600
Draci Brno	10 - 8	4 - 9	1 - 13		8 - 8	10 - 8	5	2	2	0	1	500
Olympia Blansko	7 - 8	4 - 6	7 - 10	8 - 8		15 - 1	5	1	3	0	1	300
Nuclears Třebíč I	4 - 15	1 - 20	8 - 15	8 - 10	1 - 15		5	0	5	0	0	000

Regionální přebor U15 Východ 2018
East U15 League 2018

	Arrows	Klasik	Skokani	G	W	L	S	PCT
Arrows Ostrava		9 - 4	15 - 3	10	9	1	0	900
		10 - 8	9 - 6					
		3 - 10	16 - 2					
		23 - 0	12 - 5					
		17 - 1	zrušeno					
		21 - 1						
Klasik Frydek-Místek	4 - 9		17 - 2	12	6	6	0	500
	8 - 10		17 - 1					
	10 - 3		13 - 8					
	0 - 23		3 - 18					
	1 - 17		16 - 3					
	1 - 21		7 - 6					
Skokani Olomouc	3 - 15	2 - 17		10	1	9	0	100
	6 - 9	1 - 17						
	2 - 16	8 - 13						
	5 - 12	18 - 3						
	<i>canceled</i>	3 - 16						
		6 - 7						

Regionální přebor U13 Východ 2018
East U13 League 2018

	Klasik	Arrows	Skokani	Rybnik	Cobblers	Rawa	Cannibals	G	W	L	S	PCT
Klasik FM		12 - 6	10 - 2	7 - 0	11 - 0	11 - 0	18 - 8	12	12	0	0	1000
		6 - 3	13 - 3	7 - 0	13 - 3	16 - 0	24 - 6					
Arrows Ostrava	6 - 12		15 - 1	11 - 5	14 - 3	13 - 2	24 - 10	12	10	2	0	833
	3 - 6		9 - 3	6 - 5	11 - 3	18 - 1	19 - 8					
Skokani Olomouc	2 - 10	1 - 15		zrušeno	6 - 11	4 - 0	17 - 7	10	5	5	0	500
	3 - 13	3 - 9			8 - 3	16 - 3	18 - 4					
Silesia Rybnik	0 - 7	5 - 11	<i>canceled</i>		0 - 7	12 - 4	14 - 4	10	5	2	3	500
	0 - 7	5 - 6		22 - 2	12 - 4	28 - 2						
Cobblers Zlín	0 - 11	3 - 14	11 - 6	7 - 0		17 - 4	13 - 3	12	5	7	0	417
	3 - 13	3 - 11	3 - 8	2 - 22		1 - 8	15 - 2					
Rawa Katowice	0 - 11	2 - 13	0 - 4	4 - 12	4 - 17		17 - 8	12	3	9	0	250
	3 - 13	1 - 18	3 - 16	4 - 12	8 - 1		8 - 7					
Cannibals Šumperk	8 - 18	10 - 24	7 - 17	4 - 14	3 - 13	8 - 17		12	0	12	0	000
	6 - 24	8 - 19	4 - 18	2 - 28	2 - 15	7 - 8						

Regionální přebor U11 východ 2018
East U11 League 2018

	Klasik W	Arrows	Klasik R	Skokani	G	W	L	PCT
Klasik FM White		6 - 4	9 - 2	12 - 2	12	12	0	1000
		8 - 4	6 - 2	12 - 3				
		22 - 19	6 - 1	17 - 1				
		3 - 2	7 - 0	8 - 0				
Arrows Ostrava	4 - 6		9 - 4	16 - 0	12	8	4	667
	4 - 8		9 - 6	10 - 1				
	19 - 22		12 - 5	7 - 6				
	2 - 3		13 - 6	9 - 2				
Klasik FM Reds	2 - 9	4 - 9		11 - 2	12	3	9	250
	2 - 6	6 - 9		13 - 0				
	1 - 6	5 - 12		7 - 9				
	0 - 7	6 - 13		4 - 1				
Skokani Olomouc	2 - 12	0 - 16	2 - 11		12	1	11	083
	3 - 12	1 - 10	0 - 13					
	1 - 17	6 - 7	9 - 7					
	0 - 8	2 - 9	1 - 4					

Regionální přebor U10 východ 2018
East U10 League 2018

	Klasik	Arrows	Skokani	Rybník	Cobblers	Rawa	G	W	L	D	PCT
Arrows Ostrava		5 - 7	12 - 0	19 - 3	15 - 7	20 - 0	15	14	1	0	933
		9 - 2	17 - 5	14 - 2	6 - 0	22 - 1					
		13 - 5	17 - 6	6 - 0	19 - 0	6 - 0					
Klasik FM	7 - 5		4 - 5	5 - 4	6 - 9	19 - 0	15	11	4	0	733
	2 - 9		6 - 3	6 - 8	12 - 0	5 - 0					
	5 - 13		12 - 7	9 - 7	14 - 1	6 - 0					
Skokani Olomouc	0 - 12	5 - 4		5 - 3	8 - 4	6 - 5	15	9	6	0	600
	5 - 17	3 - 6		3 - 1	13 - 5	15 - 2					
	6 - 17	7 - 12		8 - 14	6 - 0	6 - 0					
HIT Opava	3 - 19	4 - 5	3 - 5		7 - 7	6 - 0	15	7	7	1	500
	2 - 14	8 - 6	1 - 3		11 - 2	7 - 0					
	0 - 6	7 - 9	14 - 8		6 - 0	15 - 5					
Cannibals Šumperk	7 - 15	9 - 6	4 - 8	7 - 7		7 - 7	15	1	12	2	133
	0 - 6	0 - 12	5 - 13	2 - 11		6 - 0					
	0 - 19	1 - 14	0 - 6	0 - 6		0 - 6					
Rawa Katowice	0 - 20	0 - 19	5 - 6	0 - 6	7 - 7		15	1	13	1	100
	1 - 22	0 - 5	2 - 15	0 - 7	0 - 6						
	0 - 6	0 - 6	0 - 6	5 - 15	6 - 0						

Regionální přebor U8 východ 2018
East U8 League 2018

	Arrows	Klasik	Skokani	HIT	G	W	L	D	PCT
Arrows Ostrava		5 - 0	15 - 5	5 - 0	9	9	0	0	1000
		14 - 7	20 - 8	14 - 13					
		15 - 9	15 - 6	15 - 10					
Klasik FM	0 - 5		0 - 5	10 - 10	8	3	4	1	438
	7 - 14		13 - 10	14 - 6					
	9 - 15		15 - 6						
Skokani Olomouc	5 - 15	5 - 0		5 - 0	9	3	5	1	389
	8 - 20	10 - 13		15 - 15					
	6 - 15	6 - 15		20 - 13					
HIT Opava	0 - 5	10 - 10	0 - 5		8	0	6	2	125
	13 - 14	6 - 14	15 - 15						
	10 - 15		13 - 20						

Regionální přebor U7 Východ 2017
East U7 League 2017

	Arrows	Skokani	Klasik	HIT	Cannibals	G	W	L	D	PCT
Arrows Ostrava		10 - 10	13 - 8	10 - 9	9 - 5	16	13	2	1	844
		4 - 8	13 - 7	10 - 7	10 - 5					
		5 - 0	15 - 11	14 - 5	8 - 2					
		6 - 10	11 - 4	10 - 9	5 - 0					
Skokani Olomouc	10 - 10		8 - 5	10 - 10	10 - 10	15	9	3	3	700
	8 - 4		12 - 11	0 - 5	5 - 4					
	0 - 5		14 - 8	10 - 2	10 - 6					
	10 - 6		0 - 5	10 - 2						
Klasik FM	8 - 13	5 - 8		15 - 11	13 - 12	16	9	7		563
	7 - 13	11 - 12		8 - 6	11 - 10					
	11 - 15	8 - 14		5 - 4	12 - 11					
	4 - 11	5 - 0		7 - 6	5 - 0					
HIT Opava	9 - 10	10 - 10	11 - 15		5 - 0	16	5	10	1	344
	7 - 10	5 - 0	6 - 8		10 - 8					
	5 - 14	2 - 10	4 - 5		8 - 6					
	9 - 10	2 - 10	6 - 7		15 - 7					
Cannibals Šumperk	5 - 9	10 - 10	12 - 13	0 - 5		15	0	14	1	033
	5 - 10	4 - 5	10 - 11	8 - 10						
	2 - 8	6 - 10	11 - 12	6 - 8						
	0 - 5		0 - 5	7 - 15						

Celkové umístění družstev v roce 2018
Final standings of teams in 2018

Oddíl <i>Club</i>	muži / men					U18				U15			U13	
	ExL	1.L	U21	RP	ČBP	ExL	MR	ČBP	MR	ČBP	OP	MR	ČBP	OP
Baryba Velký Osek	-	-	-	-	-	-	-	-	-	-	-	-	-	-
Céčko Praha				Svz-8.										
Eagles Praha	3.	-	2.	-	SF	1.;11.	2.	1.	3.	2.	Svz-2.	1.	1.	Svz-2.,3.
Fulleros de la Habana	-	-	-	Svz-3.	2.k	-	-	-	-	-	-	-	-	-
Joudrs Praha	-	-	-	-	-	-	-	-	-	-	-	-	-	-
Kotlářka Praha	4.	-	3.	Svz-7.	1.k;QF	8.	5.	3.	-	9.	Svz-4.	-	-	-
Lokomotiva Louny	-	-	-	Svz-8.	-	-	-	-	-	-	Svz-9.	-	-	-
Miners Kladno	-	-	-	Svz-5.	2.k	-	-	-	-	-	Svz-5.	-	-	Svz-6.
Old Boys Praha	-	-	-	Svz-1.	2.k	-	-	-	-	-	-	-	-	-
Painbusters Most	-	-	-	-	-	-	-	-	-	-	-	-	-	-
Piranhas Beroun	-	-	-	-	-	-	-	-	-	-	-	-	-	-
Praotci Roudnice n.L.	-	-	-	-	-	-	-	-	-	-	-	-	-	-
Rakovník Red Crayfish	-	-	-	Svz-2.	2k	-	-	-	-	-	Svz-8.	-	-	-
SaBaT Praha	-	2.	-	Svz-4.	-	5.	-	6.	-	12.	Svz-3.	Qa-5.	9.	Svz-7.
SC Chomutov	-	-	-	-	-	-	-	-	-	-	-	-	-	-
SK Kotlářka Praha	-	-	-	-	-	-	-	-	-	-	-	2.	6.	Svz-1.,5.
Tempo Titans Praha	5.	-	-	Svz-6.	2.k	-	-	-	4.	3.	Svz-1.	3.	4.	Svz-4.
Baseball Plzeň	-	-	-	-	-	-	-	-	-	-	-	-	12.	Svz-8.
Brewers Klatovy	-	-	-	-	-	-	-	-	-	-	-	-	-	-
Pigs Trhové Sviny	-	-	-	-	-	-	-	-	-	-	-	-	-	-
Sharks Sp. Poříčí	-	9.	-	-	2.k	-	-	-	-	-	-	-	-	-
Sokol Hluboká n.V.	-	1.	-	-	-	-	-	-	8.	7.	Svz-6.	-	13.	-
SC Merklín	-	-	-	-	-	-	-	-	-	-	-	-	-	-
Wolfs Domažlice	-	7.	-	-	-	-	-	-	7.	8.	Svz-7.	-	-	-
Žraloci Lednice	-	-	-	-	-	-	-	-	-	-	-	-	-	-
Blesk Jablonec n.N.	-	3.	-	-	-	-	-	-	-	-	-	Qa-4.	13.	Sv-1.
Bongo Liberec	-	-	-	-	2.k	-	-	-	-	-	-	-	-	-
Klackaři Kostelec	-	-	-	-	-	-	-	-	-	-	-	-	-	-
Orli Choceň	-	8.	-	-	-	-	-	-	-	-	-	-	16.	Sv-5.,6.
Patriots Liberec	-	-	-	-	-	6.	-	7.	-	-	Sw	-	-	Sv-4.
Rytíři Trutnov	-	-	-	-	-	-	-	-	-	-	-	-	-	Sv-3.
Sparks Mladé Buky	-	-	-	-	2.k	-	-	-	-	-	-	-	-	-
Waynes Pardubice	-	-	-	-	-	-	-	-	-	-	-	-	15.	Sv-2.

Celkové umístění družstev v roce 2018
Final standings of teams in 2018

MR	U11		U10		U9	U8		U7+U6	Oddíl Club
	ČBP	RP	ČBP	RP	MČR	ČBP	RP	RP	
-	-	SvV-5.	-	-	Q3-8.	-	SvV-3.	SvV-5.	Baryba Velký Osek Céčko Praha
-	12.	Svz-6.	7.	Svz-2.,3,	6.	DČ-2.	Svz-2.;Stč	Svz-4.,5.,6.;Stč	Eagles Praha
-	-	-	-	-	-	-	-	-	Fulleros de la Habana
-	11.	Stč-1.	-	-	Q3-6.	-	-	-	Joudrs Praha
-	-	-	-	Svz-4.	14.	DČ-3	Svz-1.	Svz-3.	Kotlářka Praha
-	-	-	-	-	-	-	-	-	Lokomotiva Louny
-	-	Svz-3./Stč-2.	-	-	13.	DČ-1.	Stč	Stč	Miners Kladno
-	-	-	-	-	-	-	-	-	Old Boys Praha
-	-	-	-	-	Q1-6.	-	-	-	Painbusters Most
-	18.	Stč-3.	-	-	-	-	Stč	Stč	Piranhas Beroun
-	-	Stč-5.	-	-	-	-	-	-	Praotci Roudnice n.L.
-	-	Stč-4.	-	-	Q3-7.	-	-	-	Rakovník Red Crayfish
-	9.	Svz-2.	-	-	Q3-5.	-	Svz-4.;Stč	Svz-8.	SaBaT Praha
-	-	-	-	-	Q1-4.	-	-	-	SC Chomutov
Qa-4.	13.	Svz-1.	-	-	-	-	-	-	SK Kotlářka Praha
4.	5.	Svz-4.,5.	5.	Svz-1.	8.	DČ-4.	Svz-3.	Svz-1.,2.,7.;Stč	Tempo Titans Praha
-	10.	Jhz-4.	14.	-	4.	DČ-6.	-	Jhz-1.;Stč	Baseball Plzeň
-	-	Jhz-3.	9.	-	Q1-7.	-	-	-	Brewers Klatovy
-	-	-	-	-	Q1-8.	-	-	Jhz-2.	Pigs Trhové Sviny
-	-	-	-	-	-	-	-	-	Sharks Sp. Poříčí
5.	6.	Jhz-1.	4.	-	Q1-5.;16	-	-	Jhz-3.,5.	Sokol Hluboká n.V.
-	-	-	-	-	-	-	-	Jhz-4.	SC Merklín
-	-	Jhz-2.	18.	-	-	-	-	Jhz-6.	Wolfs Domažlice
-	-	-	-	-	Q2-7.	-	-	-	Žraloci Lednice
Qb-4.	14.	SvV-1.	-	-	15.	-	-	SvV-4.;U6	Blesk Jablonec n.N.
-	-	-	-	-	-	-	-	-	Bongo Liberec
-	-	-	-	-	Q4-8.	-	-	SvV-1.;U6	Klackaři Kostelec
-	-	SvV-4.	-	-	-	DČ-7.	SvV-2.	SvV-2.;U6	Orlí Choceň
-	-	-	-	-	-	-	-	-	Patriots Liberec
-	15.	SvV-2.	10.	-	12.	DČ-5.	SvV-1.	SvV-3.	Rytíři Trutnov
-	-	-	-	-	-	-	-	-	Sparks Mladé Buky
-	-	SvV-3.	-	-	-	-	-	SvV-6.	Waynes Pardubice

Celkové umístění družstev v roce 2018
Final standings of teams in 2018

Oddíl <i>Club</i>	muži / men					U18				U15			U13	
	ExL	1.L	U21	RP	ČBP	ExL	MR	ČBP	MR	ČBP	OP	MR	ČBP	OP
Draci Brno	2.	-	1.	Jih-2.	W	9.;10.;12	1.	4.	1.	1.	Jih-1.	5.	3.	Jih-1.,2.
Hroch Brno z.s.	-	5.	-	-	-	-	-	7.	-	-	-	-	-	-
Hroši Brno	6.	-	4.	-	F	2.;3.;13.	3.	1.	2.	5.	Jih-2.	6.	5.	Jih-3.,6.
Foxes Brno	-	-	-	Jih-3.	-	-	-	-	-	-	-	-	-	-
Havlíčkův Brod	-	-	-	-	-	-	-	-	-	-	-	-	-	-
Ježci Jihlava	-	-	-	Jih-8.	-	-	-	-	-	-	-	-	-	-
Moravská Beseda	-	-	-	Jih-5.	-	-	-	-	-	-	-	-	-	-
Oilers Hodonín	-	-	-	-	-	-	-	-	-	-	-	-	-	-
Olympia Blansko	8.	-	-	Jih-1.	QF	-	-	-	-	-	-	-	-	Jih-7.
Pelikans Bučovice	-	6.	-	-	-	-	-	-	-	-	-	-	-	Jih-11.
Pipas Brno	-	-	-	-	-	-	-	-	-	-	-	-	-	-
Technika Brno	10.	-	-	Jih-4.	SF	7.	-	-	-	13.	Jih-5.	-	9.	Jih-9.
Třebíč Nuclears	7.	-	5.	Jih-7.	QF	14.	4.	2.	6.	6.	Jih-3.	Qb-4.	2.	Jih-4.,5.
Arrows Ostrava	1.	-	-	-	-	4.	6.	5.	5.	4.	Vych-1.	4.	7.	Vych-2.
Cannibals Šumperk	-	-	-	-	2.k	-	-	-	-	-	-	-	-	Vych-7.
Cobblers Zlín	-	-	-	-	-	-	-	-	-	-	-	-	-	Vych-5.
HIT Opava	-	-	-	-	-	-	-	-	-	-	-	-	-	-
Klasik Frýdek-Místek	-	4.	-	-	2.k	-	-	-	-	11.	Vych-2.	Qb-5.	11.	Vych-1.
Skokani Olomouc	9.	-	-	Jih-6.	1.k;QF	-	-	-	-	10.	Vych-3.	-	10.	Vych-3.
North East	-	-	-	-	-	-	-	-	-	-	Sw	-	-	-
Angels Trnava	-	-	-	-	-	-	-	-	-	-	Jih-4.	-	-	Jih-10.
Fighting Files Bratislava	-	-	-	Jih-9.	-	-	-	-	-	-	-	-	-	-
Gepardy Zory	-	-	-	-	-	-	-	-	-	-	-	-	-	-
Outmen Skalica	-	-	-	-	-	-	-	-	-	-	Jih-6.	-	-	Jih-8.
Rawa Katowice	-	-	-	-	-	-	-	-	-	-	-	-	-	Vych-6.
Silesia Rybnik	-	-	-	-	-	-	-	-	-	-	-	-	-	Vych-4.

zkratky	Extraliga	ExL	Extra League	finále	F	Final	divize Čechy	DČ	Division Czech
abbreviations	Český pohár	ČBP	Czech Cup	vítěz	W	Winner	divize Morava	DM	Division Morav
	První liga	1L	League One	n-té kolo	n.k	n-th round	coach pitch	CP	CoachPitch
	Regionální přebor	RP	Regional League	čtvrtfinále	QF	Quater final			
	Mistrovství ČR	MR	Czech Championship	semifinále	SF	Semi final			
				skupina	sk	group			

Celkové umístění družstev v roce 2018
Final standings of teams in 2018

MR	U11		U10		U9	U8		U7+U6	Oddíl <i>Club</i>
	ČBP	RP	ČBP	RP	MČR	ČBP	RP	RP	
2.	2.	Jih-2.	2.	Jih-2.	1.	DM-4.	Jih-4.,7.	Jih-1.,7.;U6-4.	Draci Brno
-	-	-	-	-	11.	DM-3.	Jih-1.	Jih-2.,6.;U6-3.	Hroch Brno z.s.
1.	1.	Jih-1.	1.	Jih-6.	3.	-	-	-	Hroši Brno
-	-	-	-	-	-	-	-	-	Foxes Brno
-	-	-	-	-	Q2-8.	-	-	-	Havlíčkův Brod
-	-	-	12.	Jih-3.,7.	Q4-5.	DM-7.	Jih-5.	Jih-8.,13.	Ježi Jihlava
-	-	-	-	-	-	-	-	-	Moravská Beseda
-	16.	Jih-5.	11.	Jih-4.	7.	-	Jih-6.	Jih-9.	Oilers Hodonín
6.	4.	Jih-4.	6.	Jih-5.	5.	DM-1.	Jih-5.	Jih-4.,10.;U6-5.	Olympia Blansko
-	-	-	-	-	-	DM-8.	Jih-8.	Jih-14.	PeliKans Bučovice
-	-	-	-	-	9.	DM-5.	Jih-3.	Jih-3.;U6-1.	Pipas Brno
Qa-5.	8.	Jih-6.	16.	-	10.	-	-	Jih-5.,10./J6-4.	Technika Brno
3.	3.	Jih-3.	3.	Jih-1.	2.	DM-2.	Jih-2.	Jih-11.,12.;U6-2.,6	Třebíč Nuclears
-	17.	Vych-2.	8.	Vych-1.	Q2-5.	DM-6.	Vych-1.	Vych-1.	Arrows Ostrava
-	-	-	-	Vych-5.	-	-	-	Vych-5.	Cannibals Šumperk
-	-	-	-	-	-	-	-	-	Cobblers Zlín
-	-	-	17.	Vych-4.	Q4-7.	-	Vych-4.	Vych-4.	HIT Opava
Qb-5.	7.	Vych-1.,3.	13.	Vych-2.	Q4-9.	-	Vych-2.	Vych-3.	Klasik Frýdek-Místek
-	-	Vych-4.	15.	Vych-3.	Q2-6.	-	Vych-3.	Vych-2.	Skokani Olomouc
-	-	-	-	-	-	-	-	U6	Noth East
-	-	-	-	-	-	-	-	-	Angels Trnava
-	-	-	-	-	-	-	-	-	Fighting Files Bratislava
-	-	-	-	-	-	-	-	-	Gepardy Zory
-	-	-	-	-	-	-	-	-	Outmen Skalice
-	-	-	-	Vych-6.	-	-	-	-	Rawa Katowice
-	-	-	-	-	-	-	-	-	Silesia Rybnik

<i>via</i>	Region Severozápad	Svz	<i>Region Northwest</i>
<i>via</i>	jihozápadní Čechy	Jhz	<i>Region Southwest</i>
	střední+severní Čechy	Svv	<i>Region Northeast</i>
	Region Jih	Jih	<i>Region South</i>
	Region Východ	Vych	<i>Region East</i>

Bilance vítězství a porážek v dlouhodobé části Extraligy 1993-2018
Win-lose balance in regular season of Extra League 1993-2018

	Draci	Technika	Arrows	Eagles	Tempo	Kotlářka	Blansko	Skokani	Express	Hroši	SaBaT
Draci Brno		86 - 21	80 - 20	93 - 19	83 - 11	27 - 14	63 - 8	59 - 11	38 - 9	37 - 4	11 - 6
Technika Brno	21 - 86		56 - 64	59 - 51	63 - 28	15 - 26	59 - 15	54 - 16	21 - 20	27 - 14	12 - 8
Arrows Ostrava	20 - 80	64 - 56		38 - 60	55 - 38	20 - 21	53 - 24	43 - 27	21 - 24	31 - 10	10 - 10
Eagles Praha	19 - 93	51 - 59	60 - 35		59 - 33	19 - 22	41 - 23	50 - 16	30 - 10	25 - 16	9 - 8
Tempo Titans Praha	11 - 83	28 - 63	38 - 55	33 - 59		8 - 19	48 - 23	33 - 28	19 - 19	9 - 18	8 - 12
Kotlářka Praha	14 - 27	26 - 15	21 - 20	22 - 19	19 - 8		10 - 1	38 - 3	6 - 3	32 - 9	
Olympia Blansko	8 - 63	15 - 59	24 - 53	23 - 41	23 - 48	1 - 7		15 - 24	13 - 21	0 - 12	6 - 14
Skokani Olomouc	11 - 59	16 - 54	27 - 43	16 - 50	28 - 33	3 - 38	24 - 15		10 - 22	17 - 24	1 - 3
MZLU Express Brno	9 - 38	20 - 21	24 - 21	10 - 30	19 - 19	3 - 6	21 - 13	22 - 10		6 - 3	
Hroši Brno	4 - 37	14 - 27	10 - 31	16 - 25	18 - 9	9 - 32	12 - 0	24 - 17	3 - 6		
SaBaT Praha	6 - 11	8 - 12	10 - 10	8 - 9	12 - 8		14 - 6	3 - 1			
SB Rýchory	0 - 12	2 - 13	7 - 9	3 - 12	3 - 6		5 - 8		2 - 8		
Nuclears Třebíč	1 6	4 3	0 7	0 7	3 4	1 6	6 1	4 3		1 6	
Hippos Ostrava	0 - 8	0 - 8	3 - 8	1 - 7	2 - 12		1 - 10	5 - 0			0 - 3
DF Horní Suchá	0 - 3	1 - 5	1 - 5	2 - 1	2 - 4		2 - 4				1 - 5
Lokomotiva Louny	0 - 6	2 - 4	0 - 6	2 - 1	2 - 4		1 - 5				1 - 5
Patriots Liberec	0 - 5	1 - 4	1 - 4	2 - 3	3 - 2			0 - 5	3 - 2		
Orlice Choceň	0 - 6	0 - 6	2 - 10	0 - 6	2 - 10		1 - 8				
Brněnská kola	0 - 4	0 - 4	1 - 3	0 - 4	1 - 3		1 - 3				1 - 3
Sokol Hluboká	0 - 2	1 - 5	1 - 5	0 - 3	1 - 2		0 - 6		0 - 3		
Chemie Praha		0 - 3	0 - 2	1 - 2	0 - 3		0 - 3				0 - 3

Bilance vítězství a porážek v dlouhodobé části Extraligy 1993-2018
Win-lose balance in regular season of Extra League 1993-2018

	Rýchory	Nuclears	Hippos	H.Suchá	Louny	Liberec	Choceň	Kola	Hluboká	Chemie	W	L
Draci Brno	12 - 0	6 - 1	8 - 0	3 - 0	6 - 0	5 - 0	6 - 0	4 - 0	2 - 0		629	124
Technika Brno	13 - 2	3 - 4	8 - 0	5 - 1	4 - 2	4 - 1	6 - 0	4 - 0	5 - 1	3 - 0	442	339
Arrows Ostrava	9 - 7	7 - 0	8 - 3	5 - 1	6 - 0	4 - 1	10 - 2	3 - 1	5 - 1	2 - 0	414	366
Eagles Praha	12 - 3	7 - 0	7 - 1	1 - 2	1 - 2	3 - 2	6 - 0	4 - 0	3 - 0	2 - 1	409	326
Tempo Titans Praha	6 - 3	4 - 3	12 - 2	4 - 2	4 - 2	2 - 3	10 - 2	3 - 1	2 - 1	3 - 0	285	398
Kotlářka Praha		6 - 1									194	106
Olympia Blansko	8 - 5	1 - 6	10 - 1	4 - 2	5 - 1		8 - 1	3 - 1	6 - 0	3 - 0	176	359
Skokani Olomouc		3 - 4	0 - 5			5 - 0					161	350
MZLU Express Brno	8 - 2					2 - 3			3 - 0		147	166
Hroši Brno		6 - 1									116	185
SaBaT Praha			3 - 0	5 - 1	5 - 1			3 - 1		3 - 0	80	60
SB Rýchory							3 - 0				25	68
Nuclears Třebíč											20	43
Hippos Ostrava							1 - 5				13	61
DF Horní Suchá					1 - 2					2 - 1	12	30
Lokomotiva Louny				2 - 1							10	32
Patriots Liberec											10	25
Orlice Choceň	0 - 3		5 - 1								10	50
Brněnská kola											4	24
Sokol Hluboká											3	26
Chemie Praha				1 - 2							2	18

Bilance vítězství a porážek v play-off Extraligy 1993-2018

Win-lose balance in Extra League play-offs 1993-2018

série / series

	Draci	Technika	Eagles	Arrows	Tempo	Kotlářka	Express	SaBaT	Blansko	Rýchory	Skokani	Hroši	H.Suchá	W	L
Draci Brno		13 - 1	8 - 0	8 - 1	2 - 0	4 - 1	3 - 0	2 - 0	1 - 0	1 - 0	1 - 0			43	3
Technika Brno	1 - 13		3 - 3	2 - 1	4 - 1	1 - 0	1 - 0	1 - 0	1 - 0				1 - 0	15	18
Eagles Praha	0 - 8	3 - 3		0 - 3	3 - 1	1 - 2	1 - 1		2 - 0		0 - 1			10	19
Arrows Ostrava	1 - 8	1 - 2	3 - 0		1 - 1	1 - 2	1 - 1	0 - 1	0 - 1		1 - 0			9	16
Tempo Titans Praha	0 - 2	1 - 4	1 - 3	1 - 1			1 - 0	1 - 1						5	11
Kotlářka Praha	1 - 4	0 - 1	2 - 1		2 - 1									5	7
MZLU Exoress Brno	0 - 3	0 - 1	1 - 1	1 - 1	0 - 1							1 - 0		3	7
SaBaT Praha	0 - 2	0 - 1		1 - 0	1 - 1				1 - 0					3	4
Black Hill Blansko	0 - 1	0 - 1	0 - 2	1 - 0				0 - 1		0 - 1				1	6
SB Rýchory	0 - 1								1 - 0					1	1
Skokani Olomouc	0 - 1		1 - 0	0 - 1										1	2
Hroši Brno							0 - 1							0	1
DF Horní Suchá		0 - 1												0	1

utkání / games

	Draci	Technika	Eagles	Arrows	Tempo	Kotlářka	Express	SaBaT	Blansko	Skokani	Rýchory	H.Suchá	Hroši	W	L
Draci Brno		44 - 16	26 - 4	25 - 7	6 - 0	14 - 9	9 - 3	6 - 0	3 - 0	3 - 0	3 - 0			139	39
Technika Brno	16 - 44		7 - 11	7 - 10	13 - 7	3 - 1	3 - 2	4 - 3	3 - 0			3 - 2		59	80
Eagles Praha	4 - 26	11 - 7		3 - 8	10 - 8	4 - 7	4 - 3		6 - 1	1 - 3				43	63
Arrows Ostrava	7 - 25	10 - 7	8 - 3		0 - 3	2 - 6	4 - 5	1 - 3	2 - 3	3 - 1				37	56
Tempo Titans Praha	0 - 6	7 - 13	8 - 10	3 - 0			3 - 2	3 - 4						24	35
Kotlářka Praha	9 - 14	1 - 3	7 - 4	6 - 2										23	23
MZLU Express Brno	3 - 9	2 - 3	3 - 4	5 - 4	2 - 3								3 - 1	18	24
SaBaT Praha	0 - 6	3 - 4		3 - 1	4 - 3				3 - 0					13	14
Black Hill Blansko	0 - 3	0 - 3	1 - 6	3 - 2				0 - 3			1 - 3			5	20
Skokani Olomouc	0 - 3		3 - 1	1 - 3										4	7
SB Rýchory	0 - 3								3 - 1					3	4
DF Horní Suchá		2 - 3												2	3
Hroši Brno							1 - 3							1	3

Klub českých homerunářů po sezóně 2018
Czech Homerunners Club after 2018

hráč <i>player</i>	oddíl <i>club</i>	HR	1993-06	2007	2008	2009	2010	2011	2012	2013	2014	2015	2016	2017	2018
členové / members (50 HR's)															
BUDSKÝ Pavel	Dra	159	120	-	11	4	3	3	3	-	2	2	5	4	2
STŘÍTECKÝ Martin	Tech	120	73	5	7	13	5	3	2	4	3	3	1	1	-
VÍŠEK Jiří	SaB,Krč,Dra,MZL	110	110	-	-	-	-	-	-	-	-	-	-	-	-
HEJMA Matěj	Eag	98	-	-	-	1	3	-	9	7	13	15	17	16	17
MALÍK Jakub	Arr	85	22	1	-	1	-	7	4	6	8	10	7	10	9
TALDA Roman	Tech	75	75	-	-	-	-	-	-	-	-	-	-	-	-
KUČERA Ivo	Dra,Bla	67	66	-	1	-	-	-	-	-	-	-	-	-	-
SLÁDEK Jakub	Kot	67	-	-	-	-	4	2	1	7	24	15	4	5	5
VÍŠEK Miroslav	Krč	64	64	-	-	-	-	-	-	-	-	-	-	-	-
MAREK Jiří	Tech	63	1	-	1	-	3	11	14	18	5	7	3	-	-
PŘIBYL Tomáš	Dra,Tech	63	63	-	-	-	-	-	-	-	-	-	-	-	-
NAVRÁTIL Aleš	Arr	55	36	1	-	3	-	2	2	1	3	2	-	2	3
REJMAN Marek	SaB,Krč,MZL,Tem	53	51	-	-	-	-	-	-	1	-	1	-	-	-
SCHNEIDER Martin	Dra	51	2	-	-	-	5	7	6	7	2	8	9	5	-
kandidáti / candidates															
Juněk Tomáš	Arr	41	-	-	-	-	-	-	6	-	-	9	11	9	6
Joyce Terrell	Dra,Arr	40	-	-	-	-	-	-	-	-	-	-	-	11	29
Goleš Petr	Tech	38	38	-	-	-	-	-	-	-	-	-	-	-	-
Vavruša Daniel	Kot	38	-	-	-	-	-	1	-	-	-	7	10	7	13
Vystrčil Milan	Hro,Tech	36	1	-	-	5	1	4	4	3	3	5	6	4	-
Drábek Jan	Eag	35	12	-	-	2	3	1	12	-	4	1	-	-	-
Matalík Petr	Krč	35	35	-	-	-	-	-	-	-	-	-	-	-	-
Hladký Radek	Tech	34	34	-	-	-	-	-	-	-	-	-	-	-	-
Mráz Daniel	Tech	34	-	-	1	1	1	2	8	-	8	7	3	3	-
Mužik Martin	Kot	34	-	-	-	-	-	-	-	-	1	5	15	7	6
Menšík Matěj	Tech,Hro	32	-	-	-	-	1	2	3	3	4	2	9	6	2
Winkler David	Tech,Dra	32	28	-	-	-	3	1	-	-	-	-	-	-	-
Šůcha Matěj	Kot	31	-	-	1	-	4	2	4	1	2	1	6	4	6
Derhak Alexander	Dra,Hro	29	-	-	-	-	2	8	4	3	3	4	3	-	2
Nilsson Mitchell	Kot	29	-	-	-	-	-	-	-	-	-	14	15	-	-
Voják Jakub	Sko,Arr	29	-	-	-	2	-	-	2	2	3	4	8	6	2
Břeň Michal	Dra	28	24	2	-	-	-	1	1	-	-	-	-	-	-
Čech Petr	Arr,Dra	28	2	-	-	-	-	-	-	5	8	3	5	1	4
Lawman Matthew	Tech	27	-	-	-	-	-	12	15	-	-	-	-	-	-
Deago Roger	Tech	26	24	-	-	-	-	2	-	-	-	-	-	-	-
Chroust Přemek	MZL,Hro,Dra	26	-	-	-	-	2	-	-	2	5	8	2	4	3
Krejčíř Jaroslav	Bla	25	25	-	-	-	-	-	-	-	-	-	-	-	-
Kučera František	Teg	24	24	-	-	-	-	-	-	-	-	-	-	-	-
Ovesný Tomáš	Dra	24	24	-	-	-	-	-	-	-	-	-	-	-	-
Němec Radek	Arr	23	3	1	2	3	1	6	7	-	-	-	-	-	-
Veselý Martin	Dra	23	18	1	1	1	2	-	-	-	-	-	-	-	-
Pacas Petr	Tech	22	22	-	-	-	-	-	-	-	-	-	-	-	-
Vach Radek	Tech	22	17	2	1	2	-	-	-	-	-	-	-	-	-
Castaneda Rob	Dra	21	21	-	-	-	-	-	-	-	-	-	-	-	-
Kaňok Ota	Arr	21	21	-	-	-	-	-	-	-	-	-	-	-	-
Mulhearn Scott	Tem,Kot	21	-	-	-	-	-	-	-	-	-	4	4	4	9
Polanský Tomáš	Dra	21	2	1	2	1	2	1	2	4	1	1	3	1	-
Rabinowitz Jake	Tem	21	-	-	-	-	-	-	-	-	5	7	6	2	1
Baroch Petr	Kot	20	12	-	-	1	1	2	2	-	2	-	-	-	-

Klub českých homerunářů po sezóně 2018
Czech Homerunners Club after 2018

hráč <i>player</i>	oddíl <i>club</i>	HR	1993-06	2007	2008	2009	2010	2011	2012	2013	2014	2015	2016	2017	2018
Estrada Jamie	Teg	20	20	-	-	-	-	-	-	-	-	-	-	-	-
Friedmann Zdeněk	Tech	20	20	-	-	-	-	-	-	-	-	-	-	-	-
Perlík Jan	Teg	20	20	-	-	-	-	-	-	-	-	-	-	-	-
Chadim Pavel	Tech,Dra	19	19	-	-	-	-	-	-	-	-	-	-	-	-
Sázavský Richard	Tech	19	-	-	-	-	-	2	1	9	6	-	-	-	1
Svoboda Tomáš	Tech	19	17	1	-	-	-	1	-	-	-	-	-	-	-
Žlábek Jan	Cho,Arr	19	19	-	-	-	-	-	-	-	-	-	-	-	-
Brebner Jackson	Kot	18	-	-	-	-	-	-	3	5	2	2	-	4	2
Lyon Corey	Tech	18	-	-	-	-	-	-	-	-	3	15	-	-	-
Ondráček Michal	Dra,Hro	18	-	-	-	1	-	1	1	5	-	2	5	2	1
Srbecký Josef	Lou,Krč	18	18	-	-	-	-	-	-	-	-	-	-	-	-
Zelinka Martin	Tech	18	5	1	-	1	1	4	-	5	-	1	-	-	-
... celkem 438 hráčů ... 438 <i>players in total ...</i>															
celkem / total		3936	2124	35	55	100	99	125	174	157	194	233	259	184	197

Prvních deset hráčů základní části Extraligy 1995-2018
Top ten players of Extra League (regular season), 1995-2018

	v roce	celkem		in year	total
H	64 Čuta M, Tech, 01	898 Navrátil A, MZL,Arr,Arr,Sko	SB	34 Síla P, Kot, 16	194 Hajtmar J, Dra
	63 Malík J, Arr, 05	775 Budský P, SaB,Dra		31 Schneider M, Dra, 11	157 Navrátil A, MZL,Arr,Arr,Sko
	60 Budský P, Dra, 01	676 Střítecký M, Tech		30 Hajtmar J, Dra, 10	157 Schneider M, Tech,Sko,Dra
	59 Budský P, Dra, 09	617 Malík J, Arr		28 Hejma M, Eag, 14	141 Ondráček M, MZL,Dra,Hro
	58 Drong M, Arr, 12	552 Veselý M, Kol,Dra		28 Ovesný T, Dra, 97	133 Mráz D, Tech
	58 Lawman M, Tech, 12	545 Kočí M, Tech		27 Hajtmar J, Dra, 14	133 Ovesný T, MZL,Dra,Hro
	58 Malík J, Arr, 14	523 Hajtmar J, Dra		26 Mráz D, Tech, 13	127 Síla P, Tech,Kot
	58 Malík J, Arr, 12	515 Vystrčil M, MZL,Dra,Hro,Tech		26 Kaňok O, Arr, 97	121 Hejma M, Eag
	57 4 hráči / players	506 Břeň M, Dra,MZL,Hro,Bla		26 Svoboda J, Dra, 97	117 Drong M, Sko,Arr
		465 Schneider M, Tech,Sko,Dra		24 2 hráči / players	115 Veselý M, Kol,Dra
	(AB»250)			(W+L»15)	
BA	571 Elliot, Dra, 95	440 Ough W, Dra,Tech	W-L	12-0 Goodman Joseph, Arr	971 Yatsyuk R, MZL,Dra
	535 Estrada J, Teg, 00	429 Deago R, Tech		11-0 Yatsuk R, Dra, 06	870 Pacas P, Tech
	523 Talda R, Tech, 01	406 Víšek M, Eag		10-0 Bokaj B, Arr, 16	861 Samuels G, Dra
	516 Kučera I, Bla, 96	404 Víšek J, SaB,Eag,Dra,MZL		9-0 Paul R, Dra, 96	833 Paul R, Dra
	510 Víšek J, Krč, 01	395 Srbecký J, Lou,Teg,Eag		9-0 Budský P, Dra, 02	810 Ahearne P, Dra,Kot
	509 Víšek J, Krč, 00	393 Malík A, Eag,MZL,Dra		9-0 Minařík P, Dra, 10	810 Caughey T, Tech
	509 Víšek M, Krč, 00	388 Kučera I, Dra,Bla		9-0 Robles J, Arr, 08	809 Budský P, SaB,Dra
	508 Ough W, Dra 09	387 Lawman M, Tech		9-0 Procházka R, Dra, 05	800 Procházka R, Dra,MZL
	506 Srbecký Jo, Krč, 00	386 Přebyl T, Tech,Dra		9-0 Procházka R, Dra, 09	800 Roemer W, Dra
	505 Kaňok O, Arr, 97	379 Síla P, Tech,Kot		8-0 Homolka J, Krč, 05	786 Minařík P, Rych,Dra,MZL
	(AB»250)			(IP»125,0)	
HR	20 Víšek J, Krč, 00	107 Budský P, SaB,Dra	K	137 Brammer Dylan, Sko, 17	850 Minařík P, Rych,Dra,MZL
	17 Sládek J, Kot, 14	100 Střítecký M, Tech		135 Deago R, Tech, 97	749 Kubát L, Tech,Dra,MZL,Hro
	17 Marek J, Tech, 13	81 Víšek J, SaB,Eag,Dra,MZL		134 Lisko M, Hip, 00	612 Vančura J, Teg,Tech,Kot
	16 Budský P, Dra, 01	71 Hejma M, Eag		116 Hussey John, Tech, 17	599 Červenka M, Teg,Kot
	15 Talda R, Tech, 01	69 Malík J, Arr		116 Novák Jan, Kot, 17	560 Kočí M, Tech
	15 Víšek J, Krč, 01	59 Marek J, Dra,Tech		116 Červenka M, Kot, 11	545 Mráz D, Tech
	14 Hejma M, Eag, 16	52 Sládek J, Teg,Kot		115 Yatsuk R, Dra, 05	519 Bokaj B, Arr
	14 Nilsson M, Kot, 16	51 Talda R, Tech		112 Gehle Peter, Tech, 17	503 Jonák J, Eag
	14 Joyce Terrell, Arr, 18	47 Navrátil A, MZL,Arr,Arr,Sko		112 Robles J, Arr, 09	471 Hušek M, Eag
	13 6 hráčů / players	45 Víšek M, Eag		111 Deago R, Tech, 98	458 Lisko M, Hip,Tech,Arr
	(AB»250)			(IP»125,0)	
SLG	1255 Víšek J, Krč, 00	826 Víšek J, SaB,Eag,Dra,MZL	ERA	0,00 Paul R, Dra, 99	1,07 Ahearne P, Dra,Kot
	1074 Budský P, Dra, 01	778 Deago R, Tech		0,00 Samuels G, Dra, 99	1,38 Robles J, Arr
	1073 Joyce Terrell, Arr, 18	773 Víšek M, Eag		0,29 Pacas P, Tech, 04	1,45 Yatsyuk R, MZL,Dra
	1072 Budský P, SaB, 98	695 Lawman M, Tech		0,33 Budský P, Dra, 06	1,68 Pacas P, Tech
	1067 Víšek J, Krč, 01	686 Talda R, Tech		0,47 Budský P, Dra, 03	1,75 Samuels G, Dra
	1058 Nilsson M, Kot, 15	684 Přebyl T, Tech,Dra		0,49 Janda L, Teg, 07	1,80 Deago R, Tech
	1047 Estrada J, Teg, 00	675 Pacas P, Tech		0,50 Blackmore M, Dra, 07	2,12 Caughey T, Tech
	1037 Talda R, Tech, 01	669 Ough W, Dra,Tech		0,519 Ahearne P, Dra, 11	2,30 Budský P, SaB,Dra
	1009 Víšek M, Krč, 00	665 Hejma M, Eag		0,519 Dupal Štěpán, Kot, 18	2,41 Procházka R, Dra,MZL
	1000 Víšek M, Krč, 01	641 Marek J, Dra,Tech		0,55 Barto Jeffrey, Hro, 18	2,42 Bokaj B, Arr
	(AB»250)			(PO+A+E»350)	
RBI	71 Hejma M, Eag, 16	652 Budský P, SaB,Dra	FA	212-0 Ward T, Eag, 13	995 Ward T, Eag
	66 Lawman M, Tech, 12	530 Střítecký M, Tech		208-0 Čech Petr, Dra, 18	994 Dubový A, Dra,MZL
	64 Víšek J, Krč, 01	498 Navrátil A, MZL,Arr,Arr,Sko		165-0 Madej M, Dra, 98	988 Kloc M, Dra
	63 Střítecký M, Tech, 09	414 Malík J, Arr		159-0 Budský P, Dra, 04	987 Kolář L, Bla
	62 Víšek J, Krč, 00	366 Břeň M, Dra,MZL,Hro,Bla		153-0 Střítecký Martin, Tech, 17	987 Derhak A, Dra,Tech,Dra,Hro
	61 Budský P, Dra, 01	353 Víšek J, SaB,Eag,Dra,MZL		150-0 Orálek J, Tech, 09	986 Vrbský L, Eag
	59 Víšek M, Krč, 00	329 Veselý M, Kol,Dra		142-0 Homolka J, Eag, 09	985 Orálek J, Bla,Tech
	57 Marek J, Tech, 13	326 Hejma M, Eag		142-0 Vrbský L, Eag, 10	984 Chroust R, Dra,MZL
	56 Nilsson M, Kot, 16	301 Kočí M, Tech		134-0 Matuška J, Kot, 12	984 Kremláček M, Mzl,MZL,Dra,H
	55 Budský P, Dra, 02	296 Kučera I, Dra,Bla		115-0 Brebner J, Kot, 12	983 Budský P, SaB,Dra

dřevěné pálky od roku 2002
wooden bats since 2002

tučně vyznačeny výkony roku 2018
statistics 2018 are bold

od roku 2010 stanovena pevná kritéria celkových statistik
since 2010, fixed criteria for total statistics adopted

Umístění na mistrovstvích republiky mládeže 1993-2018
Positions in Czech Youth Championships 1993-2018





Oddíl <i>Club</i>	umístění / <i>position</i>							body / <i>points</i> (5-4-3-2-1)	U18			U15			U13			U11			U9		
	1.	2.	3.	4.	5.	6.	7.+		1.	2.	3.	1.	2.	3.	1.	2.	3.	1.	2.	3.	1st	2nd	3rd
Draci Brno	43	25	12	7	7	7	1	372	10	6	1	8	4	1	7	3	6	8	9	2	10	3	2
Eagles Praha	23	21	20	11	9	7	8	290	2	6	7	8	4	6	7	5	1	6	4	2	-	2	4
SK Kotlářka Praha	10	14	12	5	13	6	7	165	2	2	-	3	2	2	2	5	3	2	2	7	1	3	-
Arrows Ostrava	7	11	10	13	11	14	12	146	4	1	4	2	6	3	1	2	2	-	2	1	-	-	-
Olympia Blansko	2	10	8	10	8	6	20	102	1	2	2	-	2	2	-	3	2	-	1	1	1	2	1
Třebíč Nuclears	4	10	10	3	2	5	7	98	-	1	2	-	-	4	1	1	2	3	3	1	-	5	1
Hroši Brno	4	5	11	5	8	4	6	91	-	1	2	-	2	1	1	1	2	2	1	2	1	-	4
Technika Brno	5	3	7	9	9	3	12	85	2	-	2	-	1	1	-	1	1	1	-	1	2	1	2
Kotlářka Praha	2	3	2	3	4	1	5	38	-	2	1	2	1	1	-	-	-	-	-	-	-	-	-
Cannibals Šumperk	1	-	4	7	5	5	7	36	-	-	-	-	-	1	1	-	2	-	-	1	-	-	-
SaBaT Praha	2	4	2	-	3	3	10	35	-	1	1	1	1	-	1	2	-	-	-	1	-	-	-
Blesk Jablonec n.N.	1	1	2	6	7	4	13	34	-	-	1	-	1	1	-	-	-	1	-	-	-	-	-
Pipas Brno	1	1	4	2	2	4	9	27	-	-	-	-	-	-	1	-	-	-	-	1	1	-	3
Tempo Titans Praha	1	-	2	4	7	2	14	26	-	-	-	-	-	-	1	-	1	-	-	1	-	-	-
Sparks Mladé Buky	1	1	5	-	-	1	4	24	-	-	-	1	1	-	-	-	1	-	-	4	-	-	-
Piráti Olomouc	3	1	-	2	-	-	3	23	-	-	-	1	-	-	1	-	-	1	1	-	-	-	-
Skokani Olomouc	1	1	2	2	2	2	10	21	1	1	-	-	-	2	-	-	-	-	-	-	-	-	-
Laso Kladno	-	2	-	2	2	2	8	14	-	-	-	-	-	-	-	1	-	-	1	-	-	-	-
Orlice Choceň	1	1	-	1	3	2	3	14	-	-	-	-	-	-	1	-	-	-	1	-	-	-	-
DTJ Trutnov	1	-	1	2	1	3	3	13	-	-	1	-	-	-	-	-	-	1	-	-	-	-	-
Sokol Hluboká n.V.	-	-	-	3	5	2	14	11	-	-	-	-	-	-	-	-	-	-	-	-	-	-	-
Klasik Frýdek-Místek	-	-	2	2	-	2	5	10	-	-	-	-	-	-	-	-	1	-	-	1	-	-	-
SB Svoboda n.Ú.	1	1	-	-	1	-	-	10	1	-	-	-	1	-	-	-	-	-	-	-	-	-	-
Angels Č.Budějovice	1	-	-	2	-	3	10	9	-	-	-	-	-	-	1	-	-	-	-	-	-	-	-
MZLU Express Brno	1	-	-	1	1	-	-	8	-	-	-	-	-	-	-	-	-	1	-	-	-	-	-
Katalpa Ostrava	-	-	-	3	1	1	1	7	-	-	-	-	-	-	-	-	-	-	-	-	-	-	-
SSS Orlová	-	-	-	3	1	2	4	7	-	-	-	-	-	-	-	-	-	-	-	-	-	-	-
Lokomotiva Louny	-	-	1	1	1	1	8	6	-	-	-	-	-	1	-	-	-	-	-	-	-	-	-
Rafani Týn n.V.	-	1	-	-	-	1	7	4	-	-	-	-	-	-	-	-	-	-	1	-	-	-	-
Spectrum Praha	-	-	1	-	1	-	-	4	-	-	-	-	-	-	-	-	1	-	-	-	-	-	-
Aligátoři Znojmo	-	-	-	1	1	1	2	3	-	-	-	-	-	-	-	-	-	-	-	-	-	-	-
Baseball Plzeň	-	-	-	1	-	-	2	2	-	-	-	-	-	-	-	-	-	-	-	-	-	-	-
Hodonín Oilers	-	-	-	1	-	-	1	2	-	-	-	-	-	-	-	-	-	-	-	-	-	-	-
SBK Rožmberk	-	-	-	1	-	-	1	2	-	-	-	-	-	-	-	-	-	-	-	-	-	-	-

Umístění na mistrovstvích republiky mládeže 1993-2018
Positions in Czech Youth Championships 1993-2018

Oddíl <i>Club</i>	umístění / <i>position</i>							body / <i>points</i>	U18			U15			U13			U11			U9		
	1.	2.	3.	4.	5.	6.	7.+	(5-4-3-2-1)	1.	2.	3.	1.	2.	3.	1.	2.	3.	1.	2.	3.	1st	2nd	3rd
ZŠ Salmova Blansko	-	-	-	1	-	-	-	2	-	-	-	-	-	-	-	-	-	-	-	-	-	-	-
Hippos Ostrava	-	-	-	-	1	2	2	1	-	-	-	-	-	-	-	-	-	-	-	-	-	-	-
Pelicans Bučovice	-	-	-	-	1	-	-	1	-	-	-	-	-	-	-	-	-	-	-	-	-	-	-
Sharks Spálené Poříčí	-	-	-	-	1	1	2	1	-	-	-	-	-	-	-	-	-	-	-	-	-	-	-
Tegola Praha	-	-	-	-	1	-	1	1	-	-	-	-	-	-	-	-	-	-	-	-	-	-	-
Brewers Klatovy	-	-	-	-	-	-	1	0	-	-	-	-	-	-	-	-	-	-	-	-	-	-	-
Dodgers Č.Budějovice	-	-	-	-	-	-	1	0	-	-	-	-	-	-	-	-	-	-	-	-	-	-	-
GoMets Liberec	-	-	-	-	-	1	2	0	-	-	-	-	-	-	-	-	-	-	-	-	-	-	-
Hroch Brno	-	-	-	-	-	-	1	0	-	-	-	-	-	-	-	-	-	-	-	-	-	-	-
Lynx Rychnov u J.	-	-	-	-	-	1	1	0	-	-	-	-	-	-	-	-	-	-	-	-	-	-	-
Magic H. Měcholupy	-	-	-	-	-	-	2	0	-	-	-	-	-	-	-	-	-	-	-	-	-	-	-
Mariners Český Dub	-	-	-	-	-	-	1	0	-	-	-	-	-	-	-	-	-	-	-	-	-	-	-
MBL Brno	-	-	-	-	-	1	5	0	-	-	-	-	-	-	-	-	-	-	-	-	-	-	-
Miners Kladno	-	-	-	-	-	-	1	0	-	-	-	-	-	-	-	-	-	-	-	-	-	-	-
Oilers Hodonín	-	-	-	-	-	-	1	0	-	-	-	-	-	-	-	-	-	-	-	-	-	-	-
Patriots Liberec	-	-	-	-	-	1	3	0	-	-	-	-	-	-	-	-	-	-	-	-	-	-	-
Piráti Žacléř	-	-	-	-	-	1	1	0	-	-	-	-	-	-	-	-	-	-	-	-	-	-	-
Rebels Rtyně v P.	-	-	-	-	-	1	-	0	-	-	-	-	-	-	-	-	-	-	-	-	-	-	-
Rytíři Trutnov	-	-	-	-	-	-	3	0	-	-	-	-	-	-	-	-	-	-	-	-	-	-	-
SB Rychory	-	-	-	-	-	-	1	0	-	-	-	-	-	-	-	-	-	-	-	-	-	-	-
Tygři Zliv	-	-	-	-	-	-	1	0	-	-	-	-	-	-	-	-	-	-	-	-	-	-	-
Vinaři Dolní Kounice	-	-	-	-	-	-	1	0	-	-	-	-	-	-	-	-	-	-	-	-	-	-	-
Waynes Pardubice	-	-	-	-	-	-	1	0	-	-	-	-	-	-	-	-	-	-	-	-	-	-	-
Wolfs Domažlice	-	-	-	-	-	-	8	0	-	-	-	-	-	-	-	-	-	-	-	-	-	-	-

Super Six 2018
 Hoofddorp, Nizozemsko
 Super Six 2018
 Hoofddorp, Netherlands



	<i>Netherlands</i>	<i>Italy</i>	<i>Spain</i>	<i>Belgium</i>	<i>Germany</i>	<i>Czechia</i>	W - L
Nizozemsko	 9 - 8	12 - 10	zrušeno	13 - 1	7 - 6	4 - 0	
Itálie	8 - 9	 8 - 5	7 - 4	11 - 1	25 - 10	4 - 1	
Španělsko	10 - 12	5 - 8	 13 - 1	9 - 1	12 - 7	3 - 2	
Belgie	<i>canceled</i>	4 - 7	1 - 13	 7 - 6	10 - 15	1 - 4	
Německo	1 - 13	1 - 11	1 - 9	6 - 7	 5 - 4	1 - 4	
Česko	6 - 7	10 - 25	7 - 12	15 - 10	4 - 5	 1 - 4	

finále / final

Itálie - Nizozemsko zrušeno Italy - Netherlands

Nizozemsko	1	<i>Netherlands</i>
Itálie	2	<i>Italy</i>
Španělsko	3	<i>Spain</i>
Belgie	4	<i>Belgium</i>
Německo	5	<i>Germany</i>
Česko	6	<i>Czechia</i>

Super Six 2018
Super Six 2018

hráč player	pálka / batting															pole / fielding					nadhaz / pitching											
	G	AB	H	2B	3B	HR	SO	BB	HP	SH	SF	RBI	SB	CS	R	BA	SLG	OBP	PO	A	E	FA	CG	W	L	SV	IP	K	R-	ER	W/L	ERA
Česká republika	5	156	44	9	-	8	35	28	4	1	5	41	-	-	42	282	494	394	116	53	9	949	-	1	4	-	38,2	14	59	52	200	12,10
Bokaj Boris	-	-	-	-	-	-	-	-	-	-	-	-	-	-	-	x	x	x	-	-	-	x	-	-	1	-	1,1	1	8	8	000	54,00
Čech Petr	5	11	4	1	-	-	-	8	-	-	1	4	-	-	5	364	545	600	21	4	-	1000	-	-	-	-	-	-	-	-	x	x
Červinka Martin	4	14	5	1	-	1	2	-	-	-	2	-	-	1	357	643	357	-	8	1	889	-	-	-	-	-	-	-	-	x	x	
Dubový Arnošt	4	9	2	-	-	-	3	2	-	-	-	-	-	-	2	222	222	364	11	-	-	1000	-	-	-	-	-	-	-	x	x	
Duffek Tomáš	-	-	-	-	-	-	-	-	-	-	-	-	-	-	-	x	x	x	-	-	-	x	-	-	-	-	-	-	3	2	x	54,00
Furko Ondřej	-	-	-	-	-	-	-	-	-	-	-	-	-	-	-	x	x	x	-	-	-	x	-	-	-	-	-	-	3	3	x	13,50
Hajtmar Jakub	4	14	2	-	-	-	1	1	-	1	-	1	-	-	143	143	200	10	12	2	917	-	-	-	-	-	-	-	-	x	x	
Hejma Matěj	5	19	5	2	-	2	5	4	-	-	-	3	-	-	8	263	684	391	10	-	1	909	-	-	-	-	-	-	-	-	x	x
Hlouch Lukáš	-	-	-	-	-	-	-	-	-	-	-	-	-	-	-	x	x	x	-	-	-	x	-	-	-	-	3,0	2	1	-	x	0,00
Chroust Přemek	5	11	4	1	-	1	2	-	-	-	-	5	-	-	5	364	727	364	1	-	-	1000	-	-	-	-	-	-	-	-	x	x
Chroust Radim	-	-	-	-	-	-	-	-	-	-	-	-	-	-	-	x	x	x	-	2	1	667	-	-	1	-	9,0	2	9	7	000	7,00
Juněk Tomáš	3	5	1	-	-	1	1	-	-	-	-	3	-	-	1	200	800	200	9	1	-	1000	-	-	-	-	-	-	-	-	x	x
Malík Jakub	5	16	6	1	-	2	2	2	2	-	1	8	-	-	5	375	813	476	4	-	1	800	-	-	-	-	-	-	-	-	x	x
Minařík Petr	-	-	-	-	-	-	-	-	-	-	-	-	-	-	-	x	x	x	-	2	-	1000	-	-	-	-	4,2	2	5	5	x	9,64
Mužik Martin	5	13	5	1	-	1	4	4	1	-	1	7	-	-	3	385	692	526	12	1	-	1000	-	-	-	-	-	-	-	-	x	x
Novák Jan	-	-	-	-	-	-	-	-	-	-	-	-	-	-	-	x	x	x	-	-	-	x	-	-	2	-	7,0	1	9	6	000	7,71
Padyšák Daniel	-	-	-	-	-	-	-	-	-	-	-	-	-	-	-	x	x	x	1	-	-	1000	-	-	-	-	1,2	-	7	7	x	37,80
Satoria Ondřej	-	-	-	-	-	-	-	-	-	-	-	-	-	-	-	x	x	x	-	1	1	500	-	-	-	-	2,2	-	5	5	x	16,88
Schneider Martin	5	19	5	1	-	-	6	4	-	-	1	1	-	-	7	263	316	375	9	15	1	960	-	1	-	-	2,0	4	-	-	1000	0,00
Tomek Jan	-	-	-	-	-	-	-	-	-	-	-	-	-	-	-	x	x	x	1	1	-	1000	-	-	-	-	-	2	4	4	x	12,00
Vavruša Daniel	4	11	2	1	-	-	5	1	-	-	1	2	-	-	2	182	273	231	25	2	-	1000	-	-	-	-	-	-	-	-	x	x
Vavruša Jiří	-	-	-	-	-	-	-	-	-	-	-	-	-	-	-	x	x	x	-	1	-	1000	-	-	-	-	2,0	-	5	5	x	22,50
Voják Jakub	3	2	-	-	-	-	-	1	1	-	-	1	-	-	1	000	000	500	-	-	-	x	-	-	-	-	-	-	-	-	x	x
Zýma Petr	5	12	3	-	-	-	4	1	-	-	-	4	-	-	2	250	250	308	2	3	1	833	-	-	-	-	-	-	-	-	x	x

Mistrovství světa U23 2018, Barranquilla+Montería, Kolumbie
Baseball World Cup U23 2018, Barranquilla+Montería, Columbia



	<i>Japan</i>	<i>Mexico</i>	<i>Taipei</i>	<i>Columbia</i>	<i>Netherlands</i>	<i>S. Africa</i>	W - L
Japonsko	7 - 2	3 - 1	7 - 2	5 - 0	13 - 0		5 - 0
Mexiko	2 - 7	2 - 1	7 - 6	14 - 7	13 - 3		4 - 1
Tchaj-wan	1 - 3	1 - 2	6 - 5	9 - 10	12 - 0		2 - 3
Kolumbie	2 - 7	6 - 7	5 - 6	9 - 5	11 - 0		2 - 3
Nizozemsko	0 - 5	7 - 14	10 - 9	5 - 9	7 - 3		2 - 3
Jihoafrická r.	0 - 13	3 - 13	0 - 12	0 - 11	3 - 7		0 - 5

	<i>Venezuela</i>	<i>Dominic.</i>	<i>Korea</i>	<i>Puerto Rico</i>	<i>Australia</i>	<i>Czechia</i>	W - L
Venezuela	7 - 2	9 - 2	7 - 2	4 - 2	8 - 2		5 - 0
Dominikán. re	2 - 7	8 - 2	9 - 6	3 - 4	8 - 7		3 - 2
Korea	2 - 9	2 - 8	6 - 3	14 - 7	14 - 3		3 - 2
Portoriko	2 - 7	6 - 9	3 - 6	3 - 2	20 - 0		2 - 3
Austrálie	2 - 4	4 - 3	7 - 14	2 - 3	5 - 3		2 - 3
Česko	2 - 8	7 - 8	3 - 14	0 - 20	3 - 5		0 - 5

Consolation Round

	<i>Columbia</i>	<i>Puerto Rico</i>	<i>Australia</i>	<i>Netherlands</i>	<i>S. Africa</i>	<i>Czechia</i>	W - L
Kolumbie	3 - 1	18 - 5	9 - 5	11 - 0	12 - 2		5 - 0
Portoriko	1 - 3	3 - 2	11 - 3	7 - 5	20 - 0		4 - 1
Austrálie	5 - 18	2 - 3	16 - 3	9 - 4	5 - 3		3 - 2
Nizozemsko	5 - 9	3 - 11	3 - 16	7 - 3	3 - 4		1 - 4
Jihoafrická r.	0 - 11	5 - 7	4 - 9	3 - 7	9 - 2		1 - 4
Česko	2 - 12	0 - 20	3 - 5	4 - 3	2 - 9		1 - 4

Super Round

	<i>Japan</i>	<i>Mexico</i>	<i>Venezuela</i>	<i>Korea</i>	<i>Taipei</i>	<i>Dominic.</i>	W - L
Japonsko	7 - 2	6 - 3	3 - 2	3 - 1	4 - 0		5 - 0
Mexiko	2 - 7	10 - 4	2 - 3	2 - 1	3 - 1		3 - 2
Venezuela	3 - 6	4 - 10	9 - 2	4 - 3	7 - 2		3 - 2
Korea	2 - 3	3 - 2	2 - 7	5 - 2	2 - 8		2 - 3
Tchaj-wan	1 - 3	1 - 2	3 - 4	2 - 5	3 - 1		1 - 4
Dominikán. re	0 - 4	1 - 3	2 - 7	8 - 2	1 - 3		1 - 4

o 3. místo / for 3rd place

Venezuela - Korea 5 - 4 Venezuela - Korea

finále / final

Japonsko - Mexiko 1 - 2 Japan - Mexico

Mexiko	1	<i>Mexico</i>	Kolumbie	7	<i>Columbia</i>
Japonsko	2	<i>Japan</i>	Portoriko	8	<i>Puerto Rico</i>
Venezuela	3	<i>Venezuela</i>	Austrálie	9	<i>Australia</i>
Korea	4	<i>Korea</i>	Nizozemsko	10	<i>Netherlands</i>
Tchaj-wan	5	<i>Taipei</i>	Jihoafrická rep.	11	<i>South Africa</i>
Dominikánská rep.	6	<i>Dominican R.</i>	Česko	12	<i>Czechia</i>

Mistrovství světa U23 2018
World Championship U23 2018



hráč player	pálka / batting																pole / fielding					nadhoz / pitching										
	G	AB	H	2B	3B	HR	SO	BB	HP	SH	SF	RBI	SB	CS	R	BA	SLG	OBP	PO	A	E	FA	CG	W	L	SV	IP	K	R-	ER	W/L	ERA
Česká republika	8	232	45	7	-	1	74	27	7	2	1	19	6	3	23	194	237	296	189	81	24	918	-	1	7	-	63,0	46	79	63	125	9,00
Blažek Šimon	4	8	1	-	-	-	4	-	-	-	-	1	-	-	-	125	125	125	2	5	2	778	-	-	-	-	4,1	5	5	5	x	10,38
Bužga Vojtěch	1	2	-	-	-	-	1	-	-	-	-	-	-	-	-	000	000	000	-	-	-	x	-	-	-	-	3,1	-	1	-	x	0,00
Cihlář Josef	-	-	-	-	-	-	-	-	-	-	-	-	-	-	-	x	x	x	-	-	-	x	-	-	-	-	2,0	1	10	9	x	40,50
Čapka Filip	-	-	-	-	-	-	-	-	-	-	-	-	-	-	-	x	x	x	-	-	-	x	-	-	1	-	2,0	2	7	6	000	27,00
Červinka Martin	8	24	8	3	-	-	6	3	-	-	-	3	1	-	4	333	458	407	7	21	3	903	-	-	-	-	-	-	-	-	x	x
Chlup Marek	4	11	2	-	-	-	2	2	2	-	-	1	-	-	2	182	182	400	6	-	-	1000	-	-	-	-	-	-	-	-	x	x
Ercoli Lukáš	-	-	-	-	-	-	-	-	-	-	-	-	-	-	-	x	x	x	-	-	-	x	-	-	-	-	1,0	-	4	3	x	27,00
Furko Ondřej	4	11	1	-	-	-	4	-	-	-	-	1	-	-	091	091	091	21	2	-	1000	-	-	1	-	5,0	4	7	6	000	10,80	
Grepl Jakub	8	24	6	-	-	1	8	4	1	-	-	2	-	1	4	250	375	379	51	7	1	983	-	-	-	-	-	-	-	-	x	x
Hlouch Lukáš	-	-	-	-	-	-	-	-	-	-	-	-	-	-	-	x	x	x	-	-	-	x	-	-	1	-	9,2	9	8	7	000	6,52
Kalábek Martin	7	15	-	-	-	-	7	-	-	-	-	-	-	-	1	000	000	000	6	1	4	636	-	-	-	-	-	-	-	-	x	x
Kraut Svatoslav	-	-	-	-	-	-	-	-	-	-	-	-	-	-	-	x	x	x	-	1	1	500	-	-	1	-	7,2	10	9	5	000	5,87
Kubica Jakub	8	21	2	1	-	-	11	3	-	-	-	-	-	-	1	095	143	208	9	20	4	879	-	-	-	-	-	-	-	-	x	x
Moštěk Filip	6	14	2	-	-	-	3	3	2	-	-	1	1	-	4	143	143	368	14	-	-	1000	-	-	-	-	-	-	-	-	x	x
Mužik Martin	8	28	7	1	-	-	8	1	2	-	1	7	1	2	3	250	286	313	39	4	2	956	-	-	-	-	-	-	-	-	x	x
Nebenführ Jan	-	-	-	-	-	-	-	-	-	-	-	-	-	-	-	x	x	x	-	-	-	x	-	-	-	-	2,0	1	4	3	x	13,50
Novotný Radim	7	24	5	1	-	-	9	3	-	-	-	-	1	-	-	208	250	296	12	2	1	933	-	-	-	-	-	-	-	-	x	x
Ondra Tomáš	1	2	1	-	-	-	-	-	-	-	-	1	-	-	-	500	500	500	-	2	1	667	-	-	1	-	8,0	5	7	5	000	5,63
Ondráček Jakub	8	20	4	1	-	-	4	1	-	-	-	-	1	-	3	200	250	238	3	1	1	800	-	-	-	-	-	-	-	-	x	x
Padyšák Daniel	-	-	-	-	-	-	-	-	-	-	-	-	-	-	-	x	x	x	-	-	1	000	-	-	2	-	9,0	5	9	7	000	7,00
Satoria Ondřej	-	-	-	-	-	-	-	-	-	-	-	-	-	-	-	x	x	x	-	1	-	1000	-	-	-	-	3,0	2	3	3	x	9,00
Smola Filip	5	15	4	-	-	-	3	5	-	2	-	3	-	-	1	267	267	450	10	11	-	1000	-	-	-	-	-	-	-	-	x	x
Trunkát Lukáš	6	11	2	-	-	-	3	2	-	-	-	-	-	-	-	182	182	308	9	1	3	769	-	-	-	-	-	-	-	-	x	x
Vavruša Jiří	1	2	-	-	-	-	1	-	-	-	-	-	-	-	-	000	000	000	-	2	-	1000	-	1	-	-	6,0	2	5	4	1000	6,00

Akademické mistrovství světa 2018, Chiayi, Tchaj-wan
FISU World University Baseball 2018, Chiayi, Taiwan







**BASEBALL
2018**

A	<i>Taipei</i>	<i>Korea</i>	<i>Czechia</i>	<i>Australia</i>	W - L
Tchaj-wan	 12 - 2	11 - 0	10 - 0		3 - 0
Korea	2 - 12	 10 - 9	20 - 5		2 - 1
Česko	0 - 11	9 - 10	 22 - 6		1 - 2
Austrálie	0 - 10	5 - 20	6 - 22		0 - 3

B	<i>Japan</i>	<i>USA</i>	<i>Russia</i>	<i>Hong Kong</i>	W - L
Japonsko	 5 - 0	15 - 0	21 - 1		3 - 0
USA	0 - 5	 12 - 2	16 - 1		2 - 1
Rusko	0 - 15	2 - 12	 19 - 11		1 - 2
Hongkong	1 - 21	1 - 16	11 - 19		0 - 3

Finálová skupina / Super Round

	<i>Japan</i>	<i>Taiwan</i>	<i>USA</i>	<i>Korea</i>	W - L
Japonsko	 2 - 0	5 - 0	15 - 0		3 - 0
Tchaj-wan	0 - 2	 8 - 7	12 - 2		2 - 1
USA	0 - 5	7 - 8	 3 - 2		1 - 2
Korea	0 - 15	2 - 12	2 - 3		0 - 3

Consolation Round

	<i>Czechia</i>	<i>Russia</i>	<i>Hong Kong</i>	<i>Australia</i>	W - L
Česko	 13 - 3	12 - 2	22 - 6		3 - 0
Rusko	3 - 13	 19 - 11	16 - 1		2 - 1
Hongkong	2 - 12	11 - 19	 6 - 2		1 - 2
Austrálie	6 - 22	1 - 16	2 - 6		0 - 3

o 7. místo / <i>for 7th place</i>	Austrálie - Hongkong 6 - 3	<i>Australia - Hong Kong</i>
o 5. místo / <i>for 5th place</i>	Česko - Rusko 6 - 1	<i>Czechia - Russia</i>
o 3. místo / <i>for 3rd place</i>	Korea - USA 7 - 4	<i>Korea - USA</i>
finále / <i>final</i>	Japonsko - Tchaj-wan 8 - 3	<i>Japan - Taiwan</i>

Japonsko	1	<i>Japan</i>
Tchaj-wan	2	<i>Taiwan</i>
Korea	3	<i>Korea</i>
USA	4	<i>USA</i>
Česko	5	<i>Czechia</i>
Rusko	6	<i>Russia</i>
Austrálie	7	<i>Australia</i>
Hongkong	8	<i>Hong Kong</i>

Akademické mistrovství světa 2018
FISU World University Baseball 2018

hráč player	pálka / batting															pole / fielding					nadhoz / pitching											
	G	AB	H	2B	3B	HR	SO	BB	HP	SH	SF	RBI	SB	CS	R	BA	SLG	OBP	PO	A	E	FA	CG	W	L	SV	IP	K	R-	ER	W/L	ERA
Česká republika	6	206	72	13	5	1	47	33	9	2	2	51	16	2	62	350	476	456	150	61	12	946	-	4	2	-	50,0	44	33	27	667	4,86
Blažka Ondřej	5	9	4	-	-	-	3	1	-	-	-	1	-	-	3	444	444	500	3	-	-	1000	-	-	-	-	-	-	-	-	x	x
Bužga Vojtěch	-	-	-	-	-	-	-	-	-	-	-	-	-	-	-	x	x	x	-	-	-	x	-	-	-	-	5,0	4	2	-	x	0,00
Chlup Marek	6	25	7	2	-	1	1	2	1	-	-	6	-	-	7	280	480	357	17	1	1	947	-	-	-	-	-	-	-	-	x	x
Cihlář Josef	-	-	-	-	-	-	-	-	-	-	-	-	-	-	-	x	x	x	-	1	-	1000	-	-	-	-	1,1	2	-	-	x	0,00
Claus Filip	6	16	4	1	-	-	5	4	-	1	-	5	-	-	4	250	313	400	48	1	1	980	-	-	-	-	-	-	-	-	x	x
Čapka Filip	1	1	-	-	-	-	-	-	-	-	-	-	-	-	-	000	000	000	-	1	-	1000	-	-	2	-	7,2	4	6	3	000	3,52
Červinka Martin	6	26	14	3	1	-	2	1	-	-	-	9	2	1	7	538	731	556	3	11	2	875	-	-	-	-	-	-	-	-	x	x
Ercoli Lukáš	1	1	-	-	-	-	-	-	-	-	-	-	-	-	-	000	000	000	-	-	-	x	-	1	-	-	3,2	4	3	2	1000	4,91
Hajtmar Adam	4	11	4	-	1	-	2	-	-	-	-	3	-	-	3	364	545	364	5	-	-	1000	-	-	-	-	-	-	-	-	x	x
Havlíček Štěpán	-	-	-	-	-	-	-	-	-	-	-	-	-	-	-	x	x	x	-	-	-	x	-	-	-	-	3,2	6	1	1	x	2,45
Lázniček Matěj	5	16	9	3	1	-	4	2	1	-	-	8	2	-	5	563	875	632	6	-	1	857	-	-	-	-	-	-	-	-	x	x
Menšík Vojtěch	5	19	8	2	1	-	6	3	2	-	-	7	3	1	6	421	632	542	6	14	2	909	-	-	-	-	-	-	-	-	x	x
Moštěk Filip	4	10	2	-	1	-	3	4	-	-	-	2	2	-	3	200	400	429	12	-	-	1000	-	-	-	-	-	-	-	-	x	x
Mužik Martin	5	20	6	2	-	-	7	3	1	-	-	4	-	-	5	300	400	417	10	3	-	1000	-	-	-	-	-	-	-	-	x	x
Nebenführ Jan	-	-	-	-	-	-	-	-	-	-	-	-	-	-	-	x	x	x	-	-	-	x	-	-	-	-	3,0	6	1	1	x	3,00
Novák Jan	-	-	-	-	-	-	-	-	-	-	-	-	-	-	-	x	x	x	-	1	-	1000	-	1	-	-	6,0	6	1	1	1000	1,50
Novotný Radim	4	5	1	-	-	-	2	3	2	-	-	-	1	-	3	200	200	600	1	1	-	1000	-	-	-	-	-	-	-	-	x	x
Ondráček Jakub	6	17	8	-	-	-	4	3	-	-	-	3	3	-	7	471	471	550	3	6	1	900	-	-	-	-	-	-	-	-	x	x
Smola Filip	6	16	2	-	-	-	4	3	2	1	2	3	1	-	5	125	125	304	4	14	4	818	-	-	-	-	-	-	-	-	x	x
Vavruša Jiří	-	-	-	-	-	-	-	-	-	-	-	-	-	-	-	x	x	x	-	2	-	1000	-	2	-	-	11,0	9	8	8	1000	6,55
Vykoukal Marko	1	1	-	-	-	-	-	-	-	-	-	-	-	-	-	000	000	000	-	2	-	1000	-	-	-	-	8,2	3	11	11	x	11,42
Vykoukal Michael	4	13	3	-	-	-	4	4	-	-	-	-	2	-	4	231	231	412	32	3	-	1000	-	-	-	-	-	-	-	-	x	x

Mistrovství Evropy U18 2018, Grosseto, Itálie
 European Championship U18 2018, Grosseto, Italy



A	<i>Netherlands</i>	<i>Czechia</i>	<i>France</i>	<i>G.Britain</i>	<i>Ukraine</i>	W	-	L
Nizozemsko		9 - 5	17 - 7	21 - 2	17 - 0	4	-	0
Česko	5 - 9		7 - 3	16 - 0	2 - 1	3	-	1
Francie	7 - 17	3 - 7		11 - 7	15 - 0	2	-	2
V. Británie	2 - 21	0 - 16	7 - 11		10 - 9	1	-	3
Ukrajina	0 - 17	1 - 2	0 - 15	9 - 10		0	-	4

B	<i>Spain</i>	<i>Italy</i>	<i>Ireland</i>	<i>Germany</i>	<i>Lithuania</i>	W	-	L
Španělsko		8 - 4	13 - 2	8 - 1	17 - 4	4	-	0
Itálie	4 - 8		10 - 9	12 - 4	13 - 2	3	-	1
Irsko	2 - 13	9 - 10		11 - 3	26 - 5	2	-	2
Německo	1 - 8	4 - 12	3 - 11		15 - 0	1	-	3
Litva	4 - 17	2 - 13	5 - 26	0 - 15		0	-	4

o 7.-10. místo / for 7th-10th place

V. Británie - Litva	7 - 10	<i>G.Britain - Lithuania</i>
Německo - Ukrajina	17 - 2	<i>Germany - Ukraine</i>
Německo - V. Británie	9 - 1	<i>Germany - G. Britaine</i>
Ukrajina - Lithuania	2 - 7	<i>Ukraine - Lithuania</i>

o 5. místo / for 5th place

Irsko - Francie	6 - 7	<i>Ireland - France</i>
-----------------	-------	-------------------------

semifinále / semi finals

Nizozemsko - Itálie	12 - 2	<i>Netherlands - Italy</i>
Španělsko - Česko	6 - 1	<i>Spain - Czechia</i>

o 3. místo / for 3rd place

Česko - Itálie	4 - 3	<i>Czechia - Italy</i>
----------------	-------	------------------------

finále / final

Nizozemsko - Španělsko	6 - 3	<i>Netherlands - Spain</i>
------------------------	-------	----------------------------

Nizozemsko	1	<i>Netherlands</i>
Španělsko	2	<i>Spain</i>
Česko	3	<i>Czechia</i>
Itálie	4	<i>Italy</i>
Francie	5	<i>France</i>
Irsko	6	<i>Ireland</i>
Německo	7	<i>Germany</i>
Litva	8	<i>Lithuania</i>
Velká Británie	9	<i>Great Britain</i>
Ukrajina	10	<i>Ukraine</i>

Mistrovství Evropy U18 2018
European Championship U18 2018

hráč player	pálka / batting																pole / fielding					nadhoz / pitching										
	G	AB	H	2B	3B	HR	SO	BB	HP	SH	SF	RBI	SB	CS	R	BA	SLG	OBP	PO	A	E	FA	CG	W	L	SV	IP	K	R-	ER	W/L	ERA
Česká republika	6	188	44	4	-	-	42	29	2	7	-	18	9	2	35	234	255	342	147	63	12	946	1	4	2	1	49,0	45	22	17	667	3,12
Aschermann Martin	6	23	5	-	-	-	5	3	-	-	-	3	-	-	2	217	217	308	8	-	-	1000	-	-	-	-	-	-	-	-	x	x
Blažek Šimon	5	17	3	-	-	-	9	2	-	-	-	1	1	-	2	176	176	263	2	6	-	1000	1	1	-	-	6,0	7	-	-	1000	0,00
Claus Martin	6	22	5	2	-	-	5	2	-	1	-	-	-	-	3	227	318	292	42	4	-	1000	-	-	-	-	-	-	-	-	x	x
Černý Daniel	4	12	2	-	-	-	4	2	-	-	-	1	-	-	2	167	167	286	6	-	1	857	-	-	-	-	-	-	-	-	x	x
Grundmann Martin	-	-	-	-	-	-	-	-	-	-	-	-	-	-	-	x	x	x	-	3	-	1000	-	2	-	-	10,0	4	3	1	1000	0,90
Hlouch Lukáš	1	1	-	-	-	-	-	-	-	-	-	-	-	-	-	000	000	000	2	3	-	1000	-	-	1	-	11,0	12	8	6	000	4,91
Hrbek Tomáš	-	-	-	-	-	-	-	-	-	-	-	-	-	-	-	x	x	x	-	-	-	x	-	-	-	-	3,0	1	2	2	x	6,00
Hudeček Lukáš	5	12	4	-	-	-	2	2	-	3	-	2	3	1	2	333	333	429	9	-	-	1000	-	-	-	-	-	-	-	-	x	x
Chvátal Zdeněk	4	10	1	-	-	-	4	1	-	-	-	-	-	-	-	100	100	182	7	1	-	1000	-	-	-	-	-	-	-	-	x	x
Jurčík Tomáš	-	-	-	-	-	-	-	-	-	-	-	-	-	-	-	x	x	x	-	1	-	1000	-	1	-	-	3,2	3	1	1	1000	2,45
Kalandra Ondřej	3	11	1	-	-	-	1	-	-	-	-	-	-	-	3	091	091	091	17	3	-	1000	-	-	-	-	-	-	-	-	x	x
Krejčířik Marek	6	20	7	1	-	-	3	4	1	-	-	1	2	-	6	350	400	480	18	11	5	853	-	-	-	-	-	-	-	-	x	x
Křivánek Miroslav	4	15	5	-	-	-	1	2	-	-	-	2	1	1	3	333	333	412	6	14	2	909	-	-	-	-	-	-	-	-	x	x
Mareš David	2	5	2	1	-	-	1	-	-	-	-	2	-	-	3	400	600	400	-	-	-	x	-	-	-	-	-	-	-	-	x	x
Pacal Lukáš	-	-	-	-	-	-	-	-	-	-	-	-	-	-	-	x	x	x	-	-	-	x	-	-	-	1	1,2	2	-	-	x	0,00
Padyšák Daniel	3	8	1	-	-	-	-	4	-	-	-	1	2	-	4	125	125	417	-	2	-	1000	-	-	-	-	9,0	8	6	5	x	5,00
Puš Jáchym	5	14	5	-	-	-	2	3	-	1	-	3	-	-	3	357	357	471	5	3	3	727	-	-	-	-	-	-	-	-	x	x
Večerka Viktor	-	-	-	-	-	-	-	-	-	-	-	-	-	-	-	x	x	x	1	1	-	1000	-	-	-	-	3,2	8	-	-	x	0,00
Vojta Petr	-	-	-	-	-	-	-	-	-	-	-	-	-	-	-	x	x	x	-	-	-	x	-	-	1	-	1,0	-	2	2	000	18,00
Zelenka Martin	6	18	3	-	-	-	5	4	1	2	-	2	-	-	2	167	167	348	24	11	1	972	-	-	-	-	-	-	-	-	x	x

Mistrovství Evropy U12 2018, Budapešť, Maďarsko
European Championship U12 2018, Budapest, Hungary



A	Italy	Netherlands	Germany	Belgium	Slovakia	Austria	Croatia	W - L
Itálie	18 - 1	13 - 3	32 - 0	27 - 0	15 - 0	24 - 0	6 - 0	
Nizozemsko	1 - 18	4 - 1	18 - 4	26 - 2	19 - 4	20 - 0	5 - 1	
Německo	3 - 13	1 - 4	20 - 0	11 - 0	26 - 0	40 - 2	4 - 2	
Belgie	0 - 32	4 - 18	0 - 20	11 - 10	8 - 3	21 - 2	3 - 3	
Slovensko	0 - 27	2 - 26	0 - 11	10 - 11	8 - 6	12 - 1	2 - 4	
Rakousko	0 - 15	4 - 19	0 - 26	3 - 8	6 - 8	18 - 3	1 - 5	
Chorvatsko	0 - 24	0 - 20	2 - 40	2 - 21	1 - 12	3 - 18	0 - 6	

B	Czechia	Russia	France	Hungary	Ukraine	G.Britain	Poland	W - L
Česko	11 - 1	10 - 7	11 - 0	15 - 0	11 - 1	26 - 3	6 - 0	
Rusko	1 - 11	12 - 2	17 - 1	4 - 1	15 - 0	15 - 2	5 - 1	
Francie	7 - 10	2 - 12	12 - 1	15 - 3	26 - 4	16 - 8	4 - 2	
Maďarsko	0 - 11	1 - 17	1 - 12	3 - 2	10 - 0	12 - 6	3 - 3	
Ukrajina	0 - 15	1 - 4	3 - 15	2 - 3	12 - 7	17 - 0	2 - 4	
V. Británie	1 - 11	0 - 15	4 - 26	0 - 10	7 - 12	5 - 4	1 - 5	
Polsko	3 - 26	2 - 15	8 - 16	6 - 12	0 - 17	4 - 5	0 - 6	

semifinále / semi finals

Itálie - Rusko 5 - 4 *Italy - Russia*

Česko - Nizozemsko 10 - 5 *Czechia - Netherlands*

o 7.-14. místo / for 7-14th place

Polsko - Chorvatsko 16 - 6 *Poland - Croatia*

Maďarsko - Belgie 4 - 3 *Hungary - Belgium*

Rakousko - V. Británie 8 - 11 *Austria - G. Britain*

Slovensko - Ukrajina 1 - 13 *Slovakia - Ukraine*

o 5. místo / for 5th place

Německo - Francie 4 - 9 *Germany - France*

o 3. místo / for 3rd place

Nizozemsko - Rusko 3 - 10 *Netherlands - Russia*

finále / final

Česko - Itálie 0 - 11 *Czechia Italy*

Itálie	1	<i>Italy</i>	Belgie	8	<i>Belgium</i>
Česko	2	<i>Czechia</i>	Ukrajina	9	<i>Ukraine</i>
Rusko	3	<i>Russia</i>	Slovensko	10	<i>Slovakia</i>
Nizozemsko	4	<i>Netherlands</i>	Velká Británie	11	<i>Great Britain</i>
Francie	5	<i>France</i>	Rakousko	12	<i>Austria</i>
Německo	6	<i>Germany</i>	Polsko	13	<i>Poland</i>
Maďarsko	7	<i>Hungary</i>	Chorvatsko	14	<i>Croatia</i>

Mistrovství Evropy U12 2018
European Championship U12 2018

hráč player	pálka / batting														pole / fielding					nadhoz / pitching												
	G	AB	H	2B	3B	HR	SO	BB	HP	SH	SF	RBI	SB	CS	R	BA	SLG	OBP	PO	A	E	FA	CG	W	L	SV	IP	K	R-	ER	W/L	ERA
Česká republika	8	212	87	21	7	5	39	35	7	-	8	78	7	2	94	410	646	492	121	45	15	917	-	7	1	2	44,0	66	28	18	875	2,86
Bílíček Jan	6	6	3	1	-	1	2	-	2	-	-	4	1	1	3	500	1167	625	-	-	-	x	-	1	-	-	1,2	3	-	-	1000	0,00
Čevela Jakub	3	8	2	-	-	-	1	-	1	-	-	-	-	-	5	250	250	333	16	-	-	1000	-	-	-	-	-	-	-	-	x	x
Fejt Jan	3	2	2	2	-	-	-	1	-	-	-	2	-	-	2	1000	2000	1000	-	-	-	x	-	-	-	-	1,2	3	3	2	x	8,40
Kalandra Lukáš	5	4	-	-	-	-	1	3	-	-	-	1	-	-	2	000	000	429	-	2	-	1000	-	1	1	-	9,2	14	10	10	500	7,24
Kozel Jan	8	18	7	2	1	-	6	3	-	-	2	8	-	-	6	389	611	435	7	3	2	833	-	2	-	-	7,1	12	4	1	1000	0,95
Krejčí Jonáš	2	5	3	1	-	-	1	-	-	-	-	2	-	-	-	600	800	600	3	-	-	1000	-	-	-	-	-	-	-	-	x	x
Kubíček Filip	8	21	12	2	3	1	3	6	-	-	-	5	2	-	13	571	1238	667	4	5	4	692	-	-	-	-	-	-	-	-	x	x
Kuchaříková Kateřina	6	12	2	-	-	1	4	3	-	-	-	4	-	-	4	167	417	333	3	-	-	1000	-	1	-	-	2,1	3	1	1	1000	3,00
Lukeš Max	3	6	3	1	-	-	1	3	-	-	1	3	-	-	4	500	667	600	1	5	2	750	-	-	-	-	4,2	7	1	1	x	1,50
Malý Michal	3	9	3	1	1	-	2	-	-	-	-	2	-	-	4	333	667	333	2	4	-	1000	-	-	-	-	-	-	-	-	x	x
Moravec Jaroslav	6	16	7	1	1	1	3	2	1	-	1	11	1	-	6	438	813	500	24	1	2	926	-	-	-	-	-	-	-	-	x	x
Mück Adrian	3	8	2	-	-	-	1	-	-	-	-	3	-	-	-	250	250	250	-	1	-	1000	-	1	-	-	2,0	6	-	-	1000	0,00
O'Rourke Benjamin	6	12	7	2	-	-	6	4	1	-	-	3	1	1	5	583	750	706	11	5	1	941	-	1	-	2	8,1	10	5	-	1000	0,00
Paulík Štěpán	4	11	4	-	-	-	-	1	-	-	-	4	-	-	6	364	364	417	-	-	-	x	-	-	-	-	2,0	4	-	-	x	0,00
Soldán Mikuláš	8	19	9	2	-	1	2	5	1	-	2	11	-	-	13	474	737	556	10	1	-	1000	-	-	-	-	-	-	-	-	x	x
Šabacký Vojtěch	6	17	7	2	1	-	1	-	1	-	1	3	1	-	9	412	647	421	5	12	2	895	-	-	-	-	-	-	-	-	x	x
Ventruba Vojtěch	7	22	10	3	-	-	1	3	-	-	-	9	1	-	10	455	591	520	3	5	1	889	-	-	-	-	4,1	4	4	3	x	4,85
Wasserbauer Tomáš	6	16	4	1	-	-	4	1	-	-	1	3	-	-	2	250	313	278	32	1	1	971	-	-	-	-	-	-	-	-	x	x

Reprezentační družstva České republiky 2018
National Teams of the Czech Republic 2018

Super Six
Super Six

jméno <i>name</i>	oddíl <i>club</i>
Griffin Mike	hlavní trenér
Baroch Petr	asistent
Corey Lee	asistent
Müller Michal	asistent
Baroch Petr	Manažer
Čuhel Lubomír	asistent
Truesdale Joseph	fyzioterapeut
Bokaj Boris	Arrows Ostrava
Čech Petr	Draci Brno
Červinka Martin	Draci Brno
Dubový Arnošt	Draci Brno
Duffek Tomáš	Eagles Praha
Furko Ondřej	Draci Brno
Hajtmar Jakub	Draci Brno
Hejma Matěj	Eagles Praha
Hlouch Lukáš	Nuclears Třebíč
Chroust Přemek	Draci Brno
Chroust Radim	Draci Brno
Juněc Tomáš	Arrows Ostrava
Malík Jakub	Arrows Ostrava
Minařík Petr	Draci Brno
Mužík Martin	Kotlářka Praha
Novák Jan	Kotlářka Praha
Padyšák Daniel	Kotlářka Praha
Satoria Ondřej	Arrows Ostrava
Schneider Martin	Draci Brno
Tomek Jan	
Vavruša Daniel	Kotlářka Praha
Vavruša Jiří	SaBaT Praha
Voják Jakub	Skokani/Arrows
Zýma Petr	Eagles Praha

Akademické mistrovství světa
World University Baseball Cup

jméno <i>name</i>	oddíl <i>club</i>
Chlup Vladimír	hlavní trenér
Navrátil Aleš	asistent
Dvořák Richard	asistent
Kučera Ivo	asistent
Katzer Lukáš	fyzioterapeut
Blažka Ondřej	Kotlářka Praha
Bužga Vojtěch	Eagles Praha
Chlup Marek	Eagles Praha
Cihlář Josef	Kotlářka Praha
Claus Filip	Hroši Brno
Čapka Filip	Draci Brno
Červinka Martin	Draci Brno
Ercoli Lukáš	Kotlářka Praha
Hajtmar Adam	Draci Brno
Havlíček Štěpán	Olympia Blansko
Lázníček Matěj	Skokani Olomouc
Menšík Vojtěch	Hroši Brno
Moštěk Filip	Draci Brno
Mužík Martin	Kotlářka Praha
Nebenführ Jan	Draci Brno
Novák Jan	Kotlářka Praha
Novotný Radim	Arrows Ostrava
Ondráček Jakub	Hroši Brno
Smola Filip	Kotlářka Praha
Vavruša Jiří	SaBaT Praha
Vykoukal Marko	Arrows Ostrava
Vykoukal Michael	Arrows Ostrava

Mistrovství světa U23
World Cup U23

jméno <i>name</i>	oddíl <i>club</i>
Chlup Vladimír	hlavní trenér
Navrátil Aleš	asistent
Jablonka Ján	asistent
Hussey John	asistent
Truesdale Joseph	fyzioterapeut
Blažek Šimon	Eagles Praha
Bužga Vojtěch	Eagles Praha
Cihlář Josef	Kotlářka Praha
Čapka Filip	Draci Brno
Červinka Martin	Draci Brno
Chlup Marek	Eagles Praha
Ercoli Lukáš	Kotlářka Praha
Furko Ondřej	Draci Brno
Grepl Jakub	Arrows Ostrava
Hlouch Lukáš	Nuclears Třebíč
Kalábek Martin	Draci Brno
Kraut Svatoslav	Hroši Brno
Kubica Jakub	Arrows Ostrava
Moštěk Filip	Draci Brno
Mužík Martin	Kotlářka Praha
Nebenführ Jan	Draci Brno
Novotný Radim	Arrows Ostrava
Ondra Tomáš	Arrows Ostrava
Ondráček Jakub	Hroši Brno
Padyšák Daniel	Kotlářka Praha
Satoria Ondřej	Arrows Ostrava
Smola Filip	Kotlářka Praha
Trunkát Lukáš	Hroši Brno
Vavruša Jiří	SaBaT Praha

Reprezentační družstva České republiky 2018
National Teams of the Czech Republic 2018

Mistrovství Evropy U18
European Championship U18

jméno <i>name</i>	oddíl <i>club</i>
Winkler David	hlavní trenér
Budský Pavel	asistent
Gregor Jan	asistent
Šmidt Martin	asistent
Pospíšil Otto	fyzioterapeut
Aschermann Martin	Eagles Praha
Blažek Šimon	Eagles Praha
Chváta Zdeněk	Draci Brno
Claus Martin	Hroši Brno
Černý Daniel	Arrows Ostrava
Grundmann Michal	Sparks Ml. Buky
Hlouch Lukáš	Nuclears Třebíč
Hrbek Tomáš	Draci Brno
Hudeček Lukáš	Draci Brno
Jurčík Tomáš	Draci Brno
Kalandra Ondřej	Hroši Brno
Krejčířik Marek	Nuclears Třebíč
Křivánek Miroslav	Nuclears Třebíč
Mareš David	Rytíři Trutnov
Pacal Lukáš	Nuclears Třebíč
Padyšák Daniel	Kotlářka Praha
Puš Jáchym	Kotlářka Praha
Večerka Viktor	Draci Brno
Vojta Petr	Eagles Praha
Zelenka Martin	Tempo Titans

Mistrovství Evropy U12
European Championship U12

jméno <i>name</i>	oddíl <i>club</i>
Procházka Filip	hlavní trenér
Procházka Matouš	asistent
Ventruba Jakub	asistent
Zachoval Tomáš	asistent
Hánová Martina	fyzioterapeut
Bilíček Jan	Nuclears Třebíč
Čevela Jakub	Nuclears Třebíč
Fejt Jan	SaBaT Praha
Kalandra Lukáš	Hroši Brno
Kozel Jan	Klasik FM
Krejčí Jonáš	Technika Brno
Kubiček Filip	Eagles Praha
Kuchaříková Kateřina	Nuclears Třebíč
Lukeš Max	SK Kotlářka
Malý Michal	Draci Brno
Moravec Jaroslav	Draci Brno
Mück Adrián	Klasik FM
O'Rourke Benjamin	Tempo Titans
Paulík Štěpán	Draci Brno
Soldán Mikuláš	Hroši Brno
Šabacký Vojtěch	Nuclears Třebíč
Ventruba Vojtěch	Draci Brno
Wasserbauer Tomáš	Nuclears Třebíč

Mistrovství světa žen 2018, Viera - Florida, USA
Women's Baseball World Cup 2018, Viera - Florida, USA



	Taipei	USA	Venezuela	Puerto Rico	Korea	Netherlands	W - L
Tchaj-wan	4 - 3	9 - 1	6 - 9	13 - 0	11 - 1		4 - 1
USA	3 - 4		3 - 1	14 - 0	11 - 1	18 - 0	4 - 1
Venezuela	1 - 9	1 - 3		9 - 6	10 - 4	17 - 1	3 - 2
Portoriko	9 - 6	0 - 14	6 - 9		10 - 4	16 - 1	3 - 2
Korea	0 - 13	1 - 11	4 - 10	4 - 10		9 - 8	1 - 4
Nizozemsko	1 - 11	0 - 18	1 - 17	1 - 16	8 - 9		0 - 5

	Japan	Canada	Dominic.	Australia	Hong Kong	Cuba	W - L
Japonsko		2 - 1	8 - 0	5 - 1	23 - 0	4 - 1	5 - 0
Kanada	1 - 2		18 - 1	9 - 6	4 - 0	10 - 7	4 - 1
Dominik. rep.	0 - 8	1 - 18		9 - 6	19 - 1	0 - 12	2 - 3
Austrálie	1 - 5	6 - 9	6 - 9		24 - 2	12 - 4	2 - 3
Hongkong	0 - 23	0 - 4	1 - 19	2 - 24		8 - 5	1 - 4
Kuba	1 - 4	7 - 10	12 - 0	4 - 12	5 - 8		1 - 4

Super Round

	Japan	Taipei	USA	Canada	Venezuela	Dominic.	W - L
Japonsko		2 - 1	3 - 0	2 - 1	10 - 0	8 - 0	5 - 0
Tchaj-wan	1 - 2		4 - 3	6 - 4	9 - 1	2 - 1	4 - 1
USA	0 - 3	3 - 4		5 - 1	3 - 1	8 - 1	3 - 2
Kanada	1 - 2	4 - 6	1 - 5		5 - 0	18 - 1	2 - 3
Venezuela	0 - 10	1 - 9	1 - 3	0 - 5		12 - 2	1 - 4
Dominik. rep.	0 - 8	1 - 2	1 - 8	1 - 18	2 - 12		0 - 5

Consolation Round

	Australia	Cuba	Puerto Rico	Korea	Hong Kong	Netherlands	W - L
Austrálie		12 - 4	10 - 3	7 - 1	24 - 2	18 - 0	5 - 0
Kuba	4 - 12		6 - 5	7 - 4	5 - 8	10 - 1	3 - 2
Portoriko	3 - 10	5 - 6		10 - 4	12 - 6	16 - 1	3 - 2
Korea	1 - 7	4 - 7	4 - 10		15 - 5	9 - 8	2 - 3
Hongkong	2 - 24	8 - 5	6 - 12	5 - 15		4 - 1	2 - 3
Nizozemsko	0 - 18	1 - 10	1 - 16	8 - 9	1 - 4		0 - 5

o 3. misto / for 3rd place

Kanada - USA 8 - 5 Canada - USA

finále / final

Tchaj-wan - Japonsko 0 - 6 Taipei - Japan

Japonsko	1	Japan	Austrálie	7	Australia
Tchaj-wan	2	Taipei	Kuba	8	Cuba
Kanada	3	Canada	Portoriko	9	Puerto Rico
USA	4	USA	Korea	10	Korea
Venezuela	5	Venezuela	Hongkong	11	Hong Kong
Dominikánská rep.	6	Dominican Rep.	Nizozemsko	12	Netherlands

Mistrovství světa U15 2018, Panama Baseball World Cup U15 2018, Panama



	USA	Panama	Taipei	Brazil	China	Germany	W - L
USA		4 - 1	1 - 2	8 - 0	27 - 0	10 - 0	4 - 1
Panama	1 - 4		9 - 1	7 - 3	2 - 1	18 - 0	4 - 1
Tchaj-wan	2 - 1	1 - 9		9 - 7	10 - 0	6 - 3	4 - 1
Brazílie	0 - 8	3 - 7	7 - 9		2 - 1	10 - 0	2 - 3
Čína	0 - 27	1 - 2	0 - 10	1 - 2		5 - 4	1 - 4
Německo	0 - 10	0 - 18	3 - 6	0 - 10	4 - 5		0 - 5

	Cuba	Japan	Dominic.	Netherlands	Australia	S.Africa	W - L
Kuba		9 - 7	9 - 0	5 - 1	9 - 3	10 - 0	5 - 0
Japonsko	7 - 9		13 - 7	11 - 1	4 - 2	20 - 0	4 - 1
Dominik. rep.	0 - 9	7 - 13		11 - 2	20 - 8	5 - 3	3 - 2
Nizozemsko	1 - 5	1 - 11	2 - 11		22 - 7	18 - 2	2 - 3
Austrálie	3 - 9	2 - 4	8 - 20	7 - 22		16 - 6	1 - 4
JAR	0 - 10	0 - 20	3 - 5	2 - 18	6 - 16		0 - 5

Super Round

	USA	Panama	Japan	Taipei	Cuba	Dominic.	W - L
USA		4 - 1	8 - 2	1 - 2	10 - 0	13 - 7	4 - 1
Panama	1 - 4		7 - 3	9 - 1	4 - 2	3 - 2	4 - 1
Japonsko	2 - 8	3 - 7		5 - 2	7 - 9	13 - 7	2 - 3
Tchaj-wan	2 - 1	1 - 9	2 - 5		8 - 5	3 - 4	2 - 3
Kuba	0 - 10	2 - 4	9 - 7	5 - 8		9 - 0	2 - 3
Dominik. rep.	7 - 13	2 - 3	7 - 13	4 - 3	0 - 9		1 - 4

Consolation Round

	Brazil	Netherlands	Australia	China	Germany	S.Africa	W - L
Brazílie		11 - 1	3 - 2	2 - 1	10 - 0	10 - 0	5 - 0
Nizozemsko	1 - 11		22 - 7	6 - 2	4 - 3	18 - 2	4 - 1
Austrálie	2 - 3	7 - 22		9 - 2	8 - 2	16 - 6	3 - 2
Čína	1 - 2	2 - 6	2 - 9		5 - 4	3 - 5	1 - 4
Německo	0 - 10	3 - 4	2 - 8	4 - 5		5 - 0	1 - 4
JAR	0 - 10	2 - 18	6 - 16	5 - 3	0 - 5		1 - 4

o 3. místo / for 3rd place Tchaj-wan - Japonsko 6 - 3 Taipei - Japan

finále / final Panama - USA 1 - 7 Panama - USA

USA	1	USA	Brazílie	7	Brazil
Panama	2	Panama	Nizozemsko	8	Netherlands
Tchaj-wan	3	Taipei	Austrálie	9	Australia
Japonsko	4	Japan	Čína	10	China
Kuba	5	Cuba	Německo	11	Germany
Dominikánská rep.	6	Dominican Rep.	Jihoafrická rep.	12	South Africa

Mistrovství Evropy U15 2018 - kvalifikace
European Championship U15 2018 - Qualifier



Sisak, Chorvatsko / Sisak, Croatia

	<i>Slovakia</i>	<i>Poland</i>	<i>Romania</i>	<i>Slovenia</i>	<i>Switzerland</i>	<i>Croatia</i>	W - L
Slovensko	5 - 6	9 - 1	24 - 14	11 - 0	17 - 14	4 - 1	
Polsko	6 - 5	2 - 17	19 - 3	10 - 9	9 - 8	4 - 1	
Rumunsko	1 - 9	17 - 2	7 - 12	18 - 0	16 - 0	3 - 2	
Slovinsko	14 - 24	3 - 19	12 - 7	10 - 0	2 - 12	2 - 3	
Švýcarsko	0 - 11	9 - 10	0 - 18	0 - 10	16 - 12	1 - 4	
Chorvatsko	14 - 17	8 - 9	0 - 16	12 - 2	12 - 16	1 - 4	

Polsko - Slovensko 12 - 18 Poland - Slovakia

Mortsel, Belgie / Mortsel, Belgium

	<i>Russia</i>	<i>Hungary</i>	<i>Ukraine</i>	<i>Belgium</i>	<i>Lithuania</i>	<i>G.Britain</i>	W - L
Rusko	18 - 6	15 - 0	11 - 2	11 - 4	28 - 4	5 - 0	
Maďarsko	6 - 18	1 - 5	21 - 10	17 - 2	15 - 8	3 - 2	
Ukrajina	0 - 15	5 - 1	4 - 7	13 - 3	8 - 1	3 - 2	
Belgie	2 - 11	10 - 21	7 - 4	14 - 4	12 - 2	3 - 2	
Litva	4 - 11	2 - 17	3 - 13	4 - 14	13 - 10	1 - 4	
Velká Británie	4 - 28	8 - 15	1 - 8	2 - 12	10 - 13	0 - 5	

Rusko - Maďarsko 11 - 0 Russia - Hungary

Kvalifikace Mistrovství Evropy U23 2018, Bratislava, Slovensko
 Qualifier European Championship U23 2018, Bratislava, Slovakia



A	<i>G.Britain</i>	<i>Russia</i>	<i>Poland</i>	<i>Slovakia</i>	<i>Serbia</i>	W	-	L
Velká Británie		27 - 11	14 - 4	8 - 6	24 - 0	4	-	0
Rusko	11 - 27		13 - 7	11 - 10	11 - 0	3	-	1
Polsko	4 - 14	7 - 13		12 - 0	14 - 11	2	-	2
Slovensko	6 - 8	10 - 11	0 - 12		12 - 10	1	-	3
Srbsko	0 - 24	0 - 11	11 - 14	10 - 12		0	-	4

B	<i>Croatia</i>	<i>Ukraine</i>	<i>Switzerland</i>	<i>Belarus</i>	<i>Austria</i>	W	-	L
Chorvatsko		10 - 8	15 - 2	12 - 2	18 - 0	4	-	0
Ukrajina	8 - 10		20 - 5	16 - 2	10 - 11	2	-	2
Švýcarsko	2 - 15	5 - 20		21 - 0	8 - 7	2	-	2
Bělorusko	2 - 12	2 - 16	0 - 21		9 - 6	1	-	3
Rakousko	0 - 18	11 - 10	7 - 8	6 - 9		1	-	3

o 7.-10. místo / for 7th-10th place Slovensko - Rakousko 2 - 10 *Slovakia - Austria*

Belorusko - Srbsko 13 - 2 *Belarus - Serbia*

Slovensko - Bělorusko 4 - 7 *Slovakia - Belarus*

Rakousko - Srbsko 15 - 0 *Austria - Serbia*

o 5. místo / for 5th place Polsko - Švýcarsko 15 - 5 *Poland - Switzerland*

semifinále / semi finals Chorvatsko - Rusko 7 - 6 *Croatia - Russia*

V. Británie 5 - 7 *G.Britain - Ukraine*

o 3. místo / for 3rd place V. Británie - Rusko 23 - 4 *G.Britain - Russia*

finále / final Chorvatsko - Ukrajina 1 - 6 *Croatia - Ukraine*

Ukrajina	1	<i>Ukraine</i>
Chorvatsko	2	<i>Croatia</i>
Velká Británie	3	<i>Great Britain</i>
Rusko	4	<i>Russia</i>
Polsko	5	<i>Poland</i>
Švýcarsko	6	<i>Switzerland</i>
Bělorusko	7	<i>Belarus</i>
Rakousko	8	<i>Austria</i>
Slovensko	9	<i>Slovakia</i>
Srbsko	10	<i>Serbia</i>

Kvalifikace Mistrovství Evropy, skupina C 2018
 European Championship, C pool 2018 - Qualifier



Ashbourne, Irsko / Ashbourne, Ireland

	<i>Ireland</i>	<i>Greece</i>	<i>Finlandia</i>	<i>Slovenia</i>	<i>Norway</i>	W - L
Irsko	 10 - 0	7 - 0	18 - 0	15 - 5	4 - 0	
Řecko	0 - 10	 17 - 2	16 - 0	10 - 0	3 - 1	
Finsko	0 - 7	2 - 17	 10 - 9	22 - 4	2 - 2	
Slovinsko	0 - 18	0 - 16	9 - 10	 27 - 18	1 - 3	
Norsko	5 - 15	0 - 10	4 - 22	18 - 27	 0 - 4	

Irsko - Řecko 12 - 2 *Ireland - Greece*

Kropivnitskij, Ukrajina / Kropyvnytskyi, Ukraine

	<i>Ukraine</i>	<i>Romania</i>	<i>Georgia</i>	<i>Estonia</i>	<i>Hungary</i>	W - L
Ukrajina	 13 - 0	12 - 1	15 - 0	9 - 3	4 - 0	
Rumunsko	0 - 13	 17 - 7	4 - 5	7 - 3	2 - 2	
Gruzie	1 - 12	7 - 17	 12 - 3	16 - 9	2 - 2	
Estonsko	0 - 15	5 - 4	3 - 12	 3 - 2	2 - 2	
Maďarsko	3 - 9	3 - 7	9 - 16	2 - 3	 0 - 4	

Ukrajina - Rumunsko 3 - 2 *Ukraine - Romania*

Baseballový žebříček WBSC

WBSC Ranking

2018	2017	2016	2015	Země	Body	2018	2017	2016	2015	Country	Points
1	1	1	1	Japonsko	5796	41	52	52-53	47	Srí Lanka	111
2	2	2	2	USA	5565	42	51	49	53	Irsko	103
3	3	3	4	Korea	4987	43	45	45	54	Rumunsko	98
4	4	4	3	Tchaj-wan	3569	44-45	48	45		Bulharsko	94
5	5	5	5	Kuba	3516	44-45	38	35	36	Thajsko	94
6	6	6	7	Mexiko	3393	46-47	46	44	46	Bělorusko	89
7	7	11	13	Austrálie	2440	46-47	42	46	37	Řecko	89
8	8	9	10	Nizozemsko	2421	48	50	51	71	Srbsko	86
9	9	6	7	Venezuela	2348	49	49	50	50	Švýcarsko	73
10	10	8	8	Kanada	2186	50-51	60	58	63	Chile	68
11	11	12	11	Portoriko	2105	50-51	28	27	30	Nový Zéland	68
12	16	13	12	Dominikánská rep.	1920	52-53	44	43	49	Slovinsko	63
13	15	15	17	Panama	1522	52-53	55	54-55	57	Írán	63
14	17	19	20	Kolumbie	1340	54	53-54	64	27	Honduras	60
15	13	16	15	Nikaragua	1237	55	66-67	65	66	Curacao	54
16	12	10	9	Itálie	1135	56	57	54-55	66	Estonsko	51
17	18	17	14	Brazílie	965	57	56	52-53	55	Finsko	43
18	14	14	16	Česká republika	925	58	53-54	x	x	El Salvador	42
19	19	41	43	Izrael	817	59-60	68-70	66-68	71	Gruzie	39
20	22	18	18	Čína	612	59-60	59	57	61	Maďarsko	39
21	21	22	22	Argentina	480	61	72	x	x	Aruba	37
22	20	20	19	Německo	703	62	36	41	42	Guatemala	34
23	25	28	40	Jižní Afrika	423	63	75	x	x	Panenské ostrovy	33
24	26	24	23	Pakistán	364	64	63	60-61	63	Bolívie	30
25	24	25	26	Francie	339	65	63	60-61	59	Indie	27
26	23	21	21	Španělsko	325	66	61	59	64	Norsko	25
27	29	39	39	Rakousko	290	67	62	x	x	Guam	22
28	31	26	24	Hong Kong	247	68-69	68-70	66-68	58	Singapur	16
29	27	25	30	Rusko	230	68-69	73-74	70	70	Nepál	16
30	30	30	34	Belgie	191	70	66-67	63	57	Ekvádor	13
31	47	48	42	Indonésie	184	71	68-70	x	x	Kostarika	11
32	34	33	38	Chorvatsko	171	72	71	66-68	68	Irák	10
33	40	34	28	Filipíny	166	73-74				Bahamy	5
34-35	32	29	25	Švédsko	161	73-74				Haiti	5
34-35	43	39	31	Ukrajina	161	75		x	x	Americká Samoa	3
36-37	37	38	44	Slovensko	160	76	65	62	60	Lotyšsko	1
36-37	35	35	40	Litva	160						
38	33	29	33	Velká Británie	141	x	58	56	56	Mongolsko	
39	41	42	48	Peru	137						
40	39	52	-	Polsko	127						

Umístění v soutěžích CEB 2018

Positions in CEB Competitions 2018

	muži* men*	Mistrovství Evropy European Championships				Poháry CEB*** CEB Cups***	
		U23**	U18	U15**	U12		
Belgie	A6	A3	QA2	QB4	A8	C1;F3	<i>Belgium</i>
Bělorusko	QB ₂ 4	A14;Q7	-	-	-	C5	<i>Belarus</i>
Bulharsko	QB ₁ 5	-	-	-	-	QF ₁ 2	<i>Bulgaria</i>
Česko	A5	A2	A3	A3	A2	A5;C3	<i>Czechia</i>
Estonsko	QC ₂ 4				-		<i>Estonia</i>
Finsko	QC ₁ 3	-	-	-	-		<i>Finland</i>
Francie	A7	A6	A5	A4	A5	A4,C4	<i>France</i>
Gruzie	QC ₂ 3	A16	-	-	-		<i>Georgia</i>
Chorvatsko	A10	A8;Q2		QA6	A14	C8;F5	<i>Croatia</i>
Irsko	QC ₁ 1	-	A6	-	-	-	<i>Ireland</i>
Itálie	A3	-	A4	A5	A1	A2,3	<i>Italy</i>
Izrael	QB ₁ 2		-	-	-	-	<i>Israel</i>
Litva	QB ₂ 1	A15	A8	A10;QB5	-	QF ₂ 3	<i>Lithuania</i>
Maďarsko	QC ₂ 5	-	-	QB2	A7		<i>Hungary</i>
Německo	A4	A5	A7	A1	A6	A5;C2	<i>Germany</i>
Nizozemsko	A1	A1	A1	A2	A4	A1, 7	<i>Netherlands</i>
Norsko	QC ₁ 5	-	-	-	-	-	<i>Norway</i>
Polsko	QB ₂ 5	A10;Q5		A9;QA2	A13	QF ₁ 4;QF ₂ 2	<i>Poland</i>
Rakousko	QB ₁ 1	A13;Q8		A6	A12	F4,QF ₁ 1	<i>Austria</i>
Rumunsko	QC ₂ 2	-	-	QA3	-	QF ₁ 6	<i>Romania</i>
Rusko	A12;QB ₂ 2	A11;Q4		A8;QB1	A3	-	<i>Russia</i>
Řecko	A11;QB ₁ 6;QC ₁ 2	-	-	-	-	-	<i>Greece</i>
San Marino	-	-	-	-	-	A8	<i>San Marino</i>
Slovensko	QB ₂ 3	A12;Q9		QA1	A10	F6	<i>Slovakia</i>
Slovinsko	QC ₁ 4	-	-	QA4	-	-	<i>Slovenia</i>
Srbsko	QB ₁ 4	Q10	-	-	-	QF ₁ 4	<i>Serbia</i>
Španělsko	A2	A4	A2	A7	-	F1	<i>Spain</i>
Švédsko	A8	-		-	-	F2;QF ₂ 4	<i>Sweden</i>
Švýcarsko	QB ₁ 3	Q6		QA5	-	C7;QF ₂ 1	<i>Switzerland</i>
Ukrajina	QB ₂ 6;QC ₂ 1	A9;Q1	A10	QB3	A9	C5	<i>Ukraine</i>
Velká Británie	A9	A7;Q3	A9	QB6	A11	QF ₁ 3,QF ₂ 5	<i>Great Britain</i>

* A=2016; QB = 2017; QC = 2018

** A=2017, Q = 2018

*** A = Champions Cup

***C = CEB Cup

***F = Federation Cup

***QF = Qualifier Federation Cup

Čeští komisaři, rozhodčí a zapisovatelé v soutěžích WBSC a CEB 2018 *Czech Officials, Umpires & Scorekeepers in WBSC & CEB competitions 2018*

komisaři / commissioners

Super Six, Hoofddorp - Nizozemsko / *Super Six, Hoofddorp - Netherlands*
Jaroslav MÍKA

Mistrovství Evropy žáků, Budapešť - Maďarsko / *European Juveniles Championship, Budapest - Hungary*
Jaroslav MÍKA

Pohár C.E.B, Ostrava - Česko / *C.E.B. Cup, Ostrava - Czechia*
Tomáš ADAMEC

Pohár mistrů, Rotterdam - Nizozemsko / *Champions Cup, Rotterdam - Netherlands*
Jaroslav MÍKA

rozhodčí / umpires

Super Six, Hoofddorp - Nizozemsko / *Super Six, Hoofddorp - Netherlands*
David KULHÁNEK

Mistrovství světa U23, Barranquilla - Kolumbie / *World Championship U23, Barranquilla - Columbia*
David KULHÁNEK

Mistrovství Evropy juniorů, Grosseto - Itálie / *European Juniors Championship, Grosseto - Italy*
Jiří KROUPA

Mistrovství Evropy žáků, Budapešť - Maďarsko / *European Juveniles Championship, Budapest - Hungary*
Marek VIČAR

Pohár mistrů, Rotterdam - Nizozemsko / *Champions Cup, Rotterdam - Netherlands*
Miroslav KAIGL

Pohár C.E.B, Ostrava - Česko / *C.E.B. Cup, Ostrava - Czechia*
David KULHÁNEK, František PŘIBYL

Kvalifikace Pohár Federace, Rybnik - Polsko / *Qualifier Federations Cup, Rybnik - Poland*
Vladimír RICHTER

Junior League, Kutno - Polsko / *Junior League, Kutno - Poland*
Tomáš ŠPILAUER

Intermediate League, Praha - Česko / *Intermediate League, Prague - Czechia*
Filip HAVLÍK

zapisovatelé / skorekeepers

Kvalifikace ME U23, Bratislava - Slovensko / *Qualifier European Championship U23m Bratislava - Slovakia*
Roamana KUCKOVÁ

Mistrovství Evropy žáků, Budapešť - Maďarsko / *European Juveniles Championship, Budapest - Hungary*
Daniel KREJČIŘÍK

Pohár C.E.B, Ostrava - Česko / *C.E.B. Cup, Ostrava - Czechia*
Marina BURKOVIČOVÁ, Dalibor KUCKO, Romana KUCKOVÁ, Alexandra SLANÁ, Barbora SAVIOLA
Filip ČAPKA, Jan SVOBODA, Martin TOMAN, Romana KUCKOVÁ

Čeští rozhodčí v soutěžích WBSC (IBAF) a CEB 1992-2018
Czech umpires in WBSC (IBAF) & CEB competitions 1992-2018

			Adamec	Bajer	Brychta	Černý	Drápal	Fabiánek	Fryš	Fiala	Haertl	Havlik	Heroudek	Holcápek	Kaigl	Jaksch	Kroupa	Kulhánek	Lebeda	Mláček R.	Opatřil	Pohreich	Procházka	Prokop	Příbyl	Richter	Souček	Sury	Šimota	Špilauer	Štrba	Štrouf	Vičar	Vlček			
2018	CEB Super Six	Hoofddorp (NED)																x																			
	WBSC MSU23	Barranquilla (COL)																x																			
	CEB ME U18	Grosseto (ITA)															x																				
	CEB MEU12	Budapešť (HUN)																																x			
	CEB C.E.B. Cup	Ostrava (CZE)																	x																		
	CEB Champions Cup	Rotterdam (NED)													x																						
	CEB qual. Federation Cup	Rybnik (POL)																									x										
	LL qual. Intermediate League	Praha (CZE)										x																									
LL qual. Junior League	Kutno (POL)																															x					
2017	WBSC WBC	Soul (KOR)																							x												
	WBSC MSU12	Tainan (TPE)																									x										
	ISU Univerziáda	Tchaj-wan (TPE)													x																						
	CEB ME U23	Brno, Blansko, Trnava, Wels (CZE)					x												x																		
	CEB MEU15	Wiener-Neustadt (AUT)																									x										
	CEB MEU12	Utrecht (NED)																																x			
	CEB C.E.B. Cup	Brno, Praha (CZE)																x								x											
	CEB Champions Cup	Regensburg (GER)														x																					
	CEB qual. Federation Cup	Bratislava (SVK)																																	x		
	LL qual. Intermediate League	Praha (CZE)										x																									
LL qual. Junior League	Kutno (POL)																																x				
2016	WBSC MSU23	Monterrey (MEX)																							x												
	WBSC MSU15	Iwaki (JPN)																x																			
	CEB ME muži	Hoofddorp (NED)															x																				
	CEB MEU18	Gijon (ESP)														x																					
	CEB MEU15	Chartres, Rouen (FRA)																									x										
	CEB MEU12	Třebíč					x																														
	CEB Champions Cup	Rimini (ITA), San Marino																	x																		
	CEB Federation Cup	Brno																								x											
	CEB Qualifier Fed Cup	Sant Boi (ESP)																																		x	
	LL qual. Little League	Kutno (POL)																																	x		
LL qual. Junior League	Kutno (POL)																																	x			

Čeští rozhodčí v soutěžích WBSC (IBAF) a CEB 1992-2018
Czech umpires in WBSC (IBAF) & CEB competitions 1992-2018

			Adamec	Bajer	Brychta	Černý	Drápal	Fabiánek	Fryš	Fiala	Haertl	Havlik	Heroudek	Holcápek	Kaigl	Jaksch	Kroupa	Kulhánek	Lebeda	Mláčák R.	Opatřil	Pohreich	Procházka	Prokop	Příbyl	Richter	Souček	Sury	Šimota	Špilauer	Štrba	Štrouf	Vičar	Vlček		
2015	IBAF	MSAAA	Ósaka (JPN)														x																			
	CEB	ME AAA	Ostrava											x													x									
	CEB	ME AA	Brno												x												x									
	CEB	European Cup	Paříž (FRA)																						x											
	CEB	European Cup	Rotterdam (NED)																x																	
	CEB	qual. European Cup	Ostrava				x											x																		
	CEB	European Cup Final	Bologna, Rotterdam (ITA, NED)																							x										
	LL	qual. Intermed. League	Praha														x									x										
	LL	qual. Little League	Kutno (POL)																					x												
2014	IBAF	MSU21	Taichung (TPE)																							x										
	IBAF	MS AA	Culiacán,Mazatlán,Los Mochis (MEX)															x																		
	CEB	ME muži	Ostrava, Brno, Třebíč, Blansko																x							x										
	CEB	MEU21	Třebíč				x									x																				
	CEB	ME AA	Paderborn+Dortmund (GER)																								x									
	CEB	ME A	Lublaň (SLO)					x																												
	CEB	European Cup	Brno				x																			x										
	CEB	European Cup	Hoofddorp (NED)																x																	
	CEB	qual. European Cup	Brest (BLR)																	x																
	CEB	Play-off European Cup	Praha															x																		
	LL	qual. Intermed. League	Praha														x																		x	
	LL	qual. Little League	Kutno (POL)																					x					x							
2013	IBAF	MS AAA	Taiperi (Tchaj-wan)																							x										
	CEB	ME AAA	Praha															x	x																	
	CEB	ME AA	Nyköping, (SWE)																									x								
	CEB	ME A	Choceň																									x								
	CEB	European Cup	Barcelona (SPA)																x																	
	CEB	European Cup	Regensburg (GER)																							x										
	CEB	qual. European Cup	Karlovac (CRO)				x																													
	LL	qual. Little League	Kutno (POL)																					x									x			

Čeští rozhodčí v soutěžích WBSC (IBAF) a CEB 1992-2018
Czech umpires in WBSC (IBAF) & CEB competitions 1992-2018

			Adamec	Bajer	Brychta	Černý	Drápal	Fabiánek	Fryš	Fiala	Haertl	Havlik	Heroudek	Holcapek	Kaigl	Jaksch	Kroupa	Kulhánek	Lebeda	Mláčák R.	Opatřil	Pohreich	Procházka	Prokop	Příbyl	Richter	Souček	Sury	Šimota	Špilauer	Štrba	Štrouf	Vičar	Vlček			
2012	IBAF	qual. WBC	New Taipei City (Tchaj-wan)															x																			
	IBAF	MS AAA	Soul (Korea)															x																			
	CEB	ME muži	Rotterdam, Haarlem, Utrecht (NED)																						x												
	CEB	Haarlem week	Haarlem (NED)															x																			
	CEB	ME U 21	Brno, Třebíč				x										x																				
	CEB	ME AA	Jablonec, Liberec												x												x	x									
	CEB	ME A	Hluboká n.V.					x													x														x		
	CEB	Final Four	Nettuno (ITA)																							x											
	CEB	European Cup	San Marino (SMR)				x																			x											
	CEB	European Cup	Rotterdam (NED)																							x											
	CEB	Play-off European Cup	Brno, Zurich (*)				*											x																			
	CEB	qual. European Cup	Trnava (SVK)															x																			
	LL	qual. Little League	Kutno (POL)																																x		
2011	CEB	ME AAA	Gijon (SPA)				x																														
	CEB	ME AA	Brno (MBS), Třebíč (CZE)					x																			x	x									
	CEB	ME A	Brest (BLR)																																x		
	CEB	Final Four	Brno, MBS (CZE)	x													x	x							x												
	CEB	European Cup	Parma (ITA)															x																			
	CEB	Play-off European Cup	Brno, Kraví hora (CZE)															x																			
	CEB	qual. European Cup	Attnang-Puchheim (AUT)													x		x																			
	LL	qual. Little League	Kutno (POL)																																x		
2010	IBAF	Intercontinental Cup	Taichung (TPE)																x																		
	IBAF	MS AAA	Thunder Bay (CAN)														x																				
	CEB	ME muži	Stuttgart, Heidenhaim (GER)																x																		
	CEB	ME U21	Brno, MBS (CZE)				x										x									x											
	CEB	ME AA	Eindhoven (NED)												x																						
	CEB	ME A	Hluboká n. V. (CZE)																									x									
	CEB	qual. ME AAA	Trnava (SVK)																																	x	
	CEB	European Cup	Brno, MBS+KH (CZE)															x	x																		
	CEB	qual. European Cup	Antwerp (BEL)				x																														
CEB	Play-off European Cup	Brno, Kraví hora (CZE)	x																									x									

Čeští rozhodčí v soutěžích WBSC (IBAF) a CEB 1992-2018
Czech umpires in WBSC (IBAF) & CEB competitions 1992-2018

			Adamec	Bajer	Brychta	Černý	Drápal	Fabiánek	Fryš	Fiala	Haertl	Havlik	Heroudek	Holcapek	Kaigl	Jaksch	Kroupa	Kulhánek	Lebeda	Mičák R.	Opatřil	Pohreich	Procházka	Prokop	Příbyl	Richter	Souček	Sury	Šimota	Špilauer	Štrba	Štrouf	Vičar	Vlček		
2009	IBAF	MS	Praha (CZE)														X							X												
	IBAF	MS	Regensburg (GER)			X												X																		
	IBAF	MS AA	Taichung (TPE)																						X											
	CEB	ME AAA	Bonn (GER)														X																			
	CEB	ME AA	Brno (CZE)		X											X								X												
	CEB	ME A	Dupnitsa, Blagoevgrad (BLG)													X																				
	CEB	Final Four	Barcelona (ESP)																X																	
	CEB	European Cup	Matino (ITA)																X																	
	CEB	qual. European Cup	Ostrava (CZE)				X									X																				
CEB	qual. European Cup	Trnava (SVK)																						X												
2008	FISU	UMS	Brno, Ostrava, Olomouc (CZE)			X									X	X	X						X		X											
	CEB	qual. ME	Praha (CZE)		X	X																		X												
	CEB	ME U21	Pamplona (CZE)														X																			
	CEB	ME AA	Roma (ITA)		X																															
	CEB	ME A	Hluboká n. V. (CZE)	X																											X			X		
	CEB	European Cup	Regensburg (GER)																						X											
	CEB	qual. European Cup	Brno (CZE)													X			X																	
	CEB	Play-off European Cup	Brno (CZE)	X														X	X																	
2007	IBAF	Olympic Qualification	Barcelona (ESP)																					X												
	IBAF	Olympic Test Event	Beijing (CHN)															X																		
	CEB	ME muži	Barcelona (ESP)															X						X												
	CEB	ME AAA	Rosmalen (NED)														X																			
	CEB	ME AA	Jablonec n. N., Liberec (CZE)												X									X	X											
	CEB	ME A	Šumperk, Olomouc (CZE)				X								X					X				X												
	CEB	European Cup	San Marino (SMR)															X																		
	CEB	Cup Winners Cup	Hoofddorp (NED)				X																													
2006	FISU	UMS	Havana (CUB)													X																				
	CEB	qual. ME	Moscow (RUS)																					X												
	CEB	ME U21	Friuli Region (ITA)														X							X												
	CEB	ME AA	Gijon (ESP)															X																		
	CEB	ME A	Hluboká n. V. (CZE)	X						X																									X	
	CEB	Cup Winners Cup	Prague (CZE)							X								X							X											
	CEB	CEB Cup	Barcelona (ESP)															X																		
	CEB	qual. European Cup	Brest (BLR)												X																					
	CEB	qual. Cup Winners Cup	Ljubljana (SLO)				X																													

Čeští rozhodčí v soutěžích WBSC (IBAF) a CEB 1992-2018
Czech umpires in WBSC (IBAF) & CEB competitions 1992-2018

			Adamec	Bajer	Brychta	Černý	Drápal	Fabiánek	Fryš	Fiala	Haertl	Havlik	Heroudek	Holcápek	Kaigl	Jaksch	Kroupa	Kulhánek	Lebeda	Mláčák R.	Opatřil	Pohreich	Procházka	Prokop	Příbyl	Richter	Souček	Sury	Šimota	Špilauer	Štrba	Štrouf	Vičar	Vlček			
2005	IBAF	qual. MS 2006																							x												
	IBAF	MS AA																x																			
	CEB	ME muži				x											x	x						x	x												
	CEB	ME AAA									x																										
	CEB	ME A		x																														x			
	CEB	European Cup																	x																		
	CEB	Cup Winners Cup																						x													
	CEB	CEB Cup								x							x								x												
	CEB	qual. Cup Winners Cup				x																															
2004	FISU	UMS			x																																
	IBAF	Olympic Test Event			x																																
	CEB	ME AA		x													x	x						x											x		
	CEB	ME A									x																										
	CEB	European Cup																							x												
	CEB	Cup Winners Cup															x																				
	CEB	CEB Cup			x																																
	CEB	qual. European Cup																x						x													
2003	IBAF	MS AA									x																										
	CEB	ME muži																						x													
	CEB	ME AAA																							x												
	CEB	ME A																x																			
	CEB	European Cup			x																																
	CEB	CEB Cup															x																				
	CEB	qual. Cup Winners Cup		x							x														x											x	
2002	FISU	UMS									x																										
	CEB	ME AA																																			
	CEB	ME A					x				x																										
	CEB	European Cup			x																																
	CEB	Cup Winners Cup		x																																	
	CEB	CEB Cup															x								x												

Čeští rozhodčí v soutěžích WBSC (IBAF) a CEB 1992-2018
Czech umpires in WBSC (IBAF) & CEB competitions 1992-2018

			Adamec	Bajer	Brychta	Černý	Drápal	Fabiánek	Fryš	Fiala	Haertl	Havlik	Heroudek	Holcapfel	Kaigl	Jaksch	Kroupa	Kulhánek	Lebeda	Mláčák R.	Opatřil	Pohreich	Procházka	Prokop	Příbyl	Richter	Souček	Sury	Šimota	Špilauer	Štrba	Štrouf	Vičar	Vlček			
2001	IBAF	MS AA	Veracruz (MEX)																																		
	CEB	ME muži	Bonn (GER)		x																																
	CEB	ME AAA	Viladecans (SPA)											x																							
	CEB	ME A	Kutno (POL)																						x												
	CEB	Cup Winners Cup	Bussum (NET)						x																												
	CEB	CEB Cup	Metz (FRA)	x																																	
	CEB	qual. European Cup	Brno (CZE)					x			x																										
2000	CEB	ME AA	Pamplona (ESP)								x																										
	CEB	ME A	Choceň (CZE)										x											x													
	CEB	European Cup	San Marino (SMR)	x																		x															
	CEB	Cup Winners Cup	Grosseto (ITA)														x																				
	CEB	qual. CEB Cup	Praha (CZE)					x	x										x																		
1999	IBAF	MS AAA	Kaohsiung (TPE)	x																																	
	CEB	ME muži	Bologna, Parma, Rimini (ITA)		x																																
	CEB	ME AAA	Mainz, Wiesbaden (GER)																					x													
	CEB	ME AA	Ostrava (CZE)																																		
	CEB	ME A	Velsen (NED)								x																										
	CEB	European Cup	Nettuno (ITA)																																		
	CEB	Cup Winners Cup	Brno (CZE)	x																																	
	CEB	qual. CEB Cup	Linz (AUT)																																		
1998	IBAF	MS AAA	(CAN)		x																																
	CEB	European Cup	Viladecans (ESP)																																x		
	CEB	Cup Winners Cup	Karlovac, Zagreb (CRO)																																		
1997	IBAF																																				
	CEB	ME muži	Paris (FRA)																																x		
	CEB	ME AAA	Livorno (ITA)	x																																	
	CEB	ME AA	Choceň (CZE)																																		
CEB	Cup Winners Cup	Hoofddorp (NED)						x																													
1996	CEB	ME B	Hull (GBR)																		x																
	CEB	ME AAA	Almere (SWE)																x																		
	CEB	ME AA	Sarcelles (FRA)	x																																	
	CEB	European Cup	San Marino (SMR)			x																															
	CEB	Cup Winners Cup	Sundbyberg (SWE)																																x		

Čeští rozhodčí v soutěžích WBSC (IBAF) a CEB 1992-2018
Czech umpires in WBSC (IBAF) & CEB competitions 1992-2018

				Adamec	Bajer	Brychtia	Černý	Drápal	Fabiánek	Fryš	Fiala	Haertl	Havlik	Heroudek	Holcapfel	Kaigl	Jaksch	Kroupa	Kulhánek	Lebeda	Mičák R.	Opatřil	Pohreich	Procházka	Prokop	Příbyl	Richter	Souček	Sury	Šimota	Špilauer	Štrba	Štrouf	Vičar	Vlček	
1995	CEB	qual. European Cup	Brno (CZE)			x																														
1994	CEB	ME AAA	(NED)			x																														
1993	CEB	qual. European Cup	Brno (CZE)			x																														
1992	CEB	Cup Winners Cup	Kingston upon Hull (GB)			x																														





AAA - junioři

AA - kadeti

A - žáci

U21 - do 21 let

Pohár mistrů 2018
Champions Cup 2018
(Rotterdam - Netherlands)

A	Rimini	Huskies	Amsterdam	Heidenheim	W - L
ASD Rimini (ITA)		12 - 5	3 - 2	1 - 3	2 - 1
Rouen Huskies (FRA)	5 - 12		8 - 1	6 - 2	2 - 1
L&D Amsterdam (NED)	2 - 3	1 - 8		4 - 2	1 - 2
VOITH Heidenheim (GER)	3 - 1	2 - 6	2 - 4		1 - 2

B	Neptunus	Bologna	San Marino	Draci	W - L
Curacao Neptunus (NED)		5 - 4	3 - 0	7 - 2	3 - 0
UnipolSai Bologna (ITA)	4 - 5		12 - 4	4 - 1	2 - 1
T&A San Marino (SMR)	0 - 3	4 - 12		12 - 11	1 - 2
Draci Brno (CZE)	2 - 7	1 - 4	11 - 12		0 - 3

semifinále / semi finals

ASD Rimini 2 - 1 Bologna
 Neptunus 4 - 0 Huskies

o 5.-8. místo / for 5th-8th place

Amsterdam 0 - 8 Draci Brno
 San Marino 5 - 6 Heidenheim

o 7. místo / for 7th place

San Marino 3 - 8 Amsterdam

o 3. místo / for 3rd place

Bologna 8 - 0 Huskies





finále / final

Neptunus 5 - 0 Rimini

1	Curacao Neptunus (NED)	
2	A.S.D. Rimini (ITA)	
3	UnipolSai Bologna (ITA)	
4	Rouen Huskies (FRA)	
5	Draci Brno (CZE)	
6	VOITH Heidenheim (GER)	
7	L&D Amsterdam (NED)	
8	T&A San Marino (SMR)	

C.E.B Cup 2018
C.E.B. Cup 2018
(Ostrava - Czechia)

A	Borgerhout	Bonn	KNTU	Therwill	W - L
Borgerhout Squirrels (BEL)	 8 - 11	6 - 1	9 - 4	2 - 1	
Bonn Capitals (GER)	11 - 8	 8 - 10	11 - 0	2 - 1	
Biothechkomanda KNTU (UKR)	1 - 6	10 - 8	 7 - 9	2 - 1	
Therwill Flyers (SUI)	4 - 9	0 - 11	9 - 7	 0 - 3	

B	Arrows	Templiers	Karlovac	Minsk	W - L
Arrows Otrava (CZE)	 7 - 0	14 - 0	15 - 0	3 - 0	
Templiers Senart (FRA)	0 - 7	 20 - 11	17 - 1	2 - 1	
Olimpija Karlovac (CRO)	0 - 14	11 - 20	 16 - 13	1 - 2	
Minsk (BLR)	0 - 15	1 - 17	13 - 16	 0 - 3	

semifinále / *semi finals*

Borgerhout 6 - 4 Templiers
 Arrows 3 - 7 Bonn

o 5.-8. místo / *for 5th-8th place*

Karlovac 1 - 12 Therwill
 KNTU 4 - 6 Minsk

o 7. místo / *for 7th place*

Karlovac 4 - 5 KNTU

o 3. místo / *for 3rd place*

Arrows 8 - 0 Templiers

finále / *final*

Borgerhout 2 - 0 Bonn

1	Borgerhout Squirrels (BEL)
2	Bonn Capitals (GER)
3	Arrows Ostrava (CZE)
4	Templiers Senart (FRA)
5	Therwill Flyers (SUI)
5	Minsk (BLR)
8	Biothechkomanda KNTU (UKR)
8	Olimpija Karlovac (CRO)

Pohár federace 2018
Federations Cup 2018
(Brasschaat - Belgium)

	Sölvesborg	Valencia	Brasschaat	Puchheim	Varazdin	Apollo	W - L
Sölvesborg Firehawks (SWE)	 13 - 2	5 - 6	11 - 1	12 - 0	11 - 10	5 - 0	
Astros Valencia (ESP)	2 - 13	 13 - 2	12 - 4	12 - 2	25 - 5	4 - 1	
Brasschaat Braves (BEL)	6 - 5	2 - 13	 10 - 0	13 - 0	12 - 3	2 - 3	
Ath. Attnang-Puchheim (AUT)	1 - 11	4 - 12	0 - 10	 16 - 15	8 - 7	2 - 3	
Vindija Varazdin (CRO)	0 - 12	1 - 12	0 - 13	15 - 16	 14 - 1	1 - 4	
Apollo Bratislava (SVK)	10 - 11	5 - 25	3 - 12	7 - 8	1 - 14	 1 - 4	

finále / final

Sölvesborg 5 - 16 Valencia

- | | |
|---|-----------------------------|
| 1 | Astros Valencia (ESP) |
| c | Sölvesborg Firehawks (SWE) |
| c | Brasschaat Braves (BEL) |
| 4 | Ath. Attnang-Puchheim (AUT) |
| 5 | Vindija Varazdin (CRO) |
| 6 | Apollo Bratislava (SVK) |

Kvalifikace Pohár federace 2018
Federations Cup Qualifier 2018

Skupina 1 / Pool 1

Blagoevgrad, Bulgaria

W L

1	Vienna Wanderers (AUT)	5	-	0
2	Buffaloes Blagoevgrad (BUL)	4	-	1
3	London Mets (GBR)	2	-	2
4	Barons Wroclaw (POL)	1		2
5	Beograd '96 (SRB)	1		3
6	Atletico Alexandria (ROM)	0	-	5

finále / final



Vienna 5 - 1 Blagoevgrad

Skupina 2 / Pool 2

Rybnik, Poland

W L

1	KS Silesia Rybnik (POL)	4	-	0
2	Zurich Barracudas (SUI)	3	-	1
3	Kaunas County B.C. (LTU)	2	-	2
4	Sundbyberg (SWE)	1	-	3
5	Southampton Mustangs (GBR)	0	-	4

finále / final

Rybnik 1 - 15 Zurich



Pražský baseballový týden 2018 Prague Baseball Week 2018



	<i>Czechia</i>	<i>Stars</i>	<i>Italy</i>	<i>NSW</i>	W - L
Česko U23		9 - 3	7 - 1	9 - 0	3 - 0
3n2 International Stars	3 - 9		8 - 3	7 - 8	1 - 2
Itálie	1 - 7	3 - 8		16 - 1	1 - 2
NSW Blue Sox	0 - 9	8 - 7	1 - 16		1 - 2

	<i>Future</i>	<i>Russia</i>	<i>Belarus</i>	<i>Poland</i>	W - L
International Future Stars		13 - 3	zrušeno	6 - 1	2 - 0
Rusko	3 - 13		4 - 1	4 - 2	2 - 1
Bělorusko	<i>canceled</i>	1 - 4		9 - 6	1 - 1
Polsko	1 - 6	2 - 4	6 - 9		0 - 3

NSW - Future Stars	4 - 5	NSW - Future Stars
Polsko - NSW	8 - 12	Poland - NSW
Česko - Future Stars	12 - 6	Czechia - Future Stars
3n2 - Rusko	6 - 0	3n2 - Russia
Bělorusko - Rusko	16 - 0	Belarus - Russia
Itálie - 3n2	0 - 7	Italy - 3n2
Polsko - Rusko	2 - 12	Poland - Russia
NSW - Bělorusko	9 - 4	NSW - Belarus
Future Stars - Itálie	7 - 5	Future Stars - Italy
Česko - 3n2	1 - 10	Czechia - 3n2

o 7. místo / *for 7th place*
o 5. místo / *for 5th place*
o 3. místo / *for 3rd place*
finále / *final*

3n2 International Stars	1	3n2 International Stars
Česko U23	2	Czechia U23
International Future Stars	3	International Future Stars
Itálie	4	Italy
NSW Blue Sox	5	NSW Blue Sox
Bělorusko	6	Belarus
Rusko	7	Russia
Polsko	8	Poland

nejlepší nadhazovač / *best pitcher* - Wesley Roemer, 3n2 Int. Stars
nejlepší pálkař / *best hitter* - Jorge Volijk, Int. Future Stars
nejúžitečnější hráč / *MVP* - Martin Mužík, Czechia

Mezistátní zápasy 2018 International matches 2018

Muži / *Men*

Česko - Německo / <i>Czechia - Germany</i>	2 - 1	15 - 5	4 - 2	3 - 0
Česko - Tchaj-wan / <i>Czechia - Taiwan</i>	1 - 8	4 - 9	4 - 12	12 - 3
				1 - 3

Senior League 2018, Novara, Itálie
Senior League 2018, Novara, Italy

Itálie	1	<i>Italy</i>
Nizozemsko	2	<i>Netherlands</i>
Piemonte	3	<i>Piemonte</i>
Belgie	4	<i>Belgium</i>
Francie	5	<i>France</i>
Rakousko	6	<i>Austria</i>
*Česko	7	<i>Czechia</i>

*region Jih / *Region South*

Intermediate League 2018, Praha, Česko
Intermediate League 2018, Prague, Czechia

Česko JIH*	1	<i>Czechia</i>
Nizozemsko	2	<i>Netherlands</i>
Česko SVZ**	3	<i>Czechia</i>
Belgie	4	<i>Belgium</i>

*region Jih / *Region South*

**region Severozápad / *Region Northwest*

Junior League 2018, Kutno, Polsko
Junior League 2018, Kutno, Poland

Itálie	1	<i>Italy</i>
Německo-USA	2	<i>Germany-USA</i>
United Kingdom	3	<i>UK</i>
Chorvatsko	4	<i>Croatia</i>
*Česko	5	<i>Czechia</i>
Polsko	6	<i>Poland</i>
Rumunko	6	<i>Romania</i>
Belgie	8	<i>Belgium</i>
Maďarsko	8	<i>Hungary</i>
Litva	8	<i>Lithuania</i>

*region Jih / *Region South*

Little League 2018 - Qualifier, Kutno, Polsko
Little League 2018 - kvalifikace, Kutno, Poland

Rakousko	1	<i>Austria</i>
Bělorusko	2	<i>Belarus</i>
Chorvatsko	3	<i>Croatia</i>
Maďarsko	4	<i>Hungary</i>
Polsko	5	<i>Poland</i>
Švýcarsko	6	<i>Switzerland</i>

Little League 2018, Kutno, Polsko
Little League 2018, Kutno, Poland

Španělsko	1	<i>Spain</i>
Nizozemsko	2	<i>Netherlands</i>
Rakousko	3	<i>Austria</i>
*Česko	4	<i>Czechia</i>
Francie	5	<i>France</i>
Německo-USA	5	<i>Germany-US</i>
Bělorusko	7	<i>Belarus</i>
Itálie	7	<i>Italy</i>
Litva	7	<i>Lithuania</i>
Belgie	10	<i>Belgium</i>
Ukrajina	10	<i>Ukraine</i>
United Kingdom	10	<i>UK</i>

*region Severozápad / *Region Northwest*

Junior League Světová série 2017, Taylor, USA
Junior League World Series 2017, Taylor, USA



West - Central	7 - 0	Europe-Africa - Latin America	1 - 8
District 57 - Southwest	4 - 0	Asia-Pacific - Australia	19 - 0
West - Southeast	1 - 5	Latin America - Portoriko	2 - 1
Southwest - East	19 - 0	Asia-Pacific - Kanada	23 - 0
Central - East	9 - 3	Europe-Africa - Kanada	4 - 5
West - District 57	2 - 7	Portoriko - Australia	11 - 0
District 57 - Central	11 - 5	Portoriko - Kanada	8 - 1
Southwest - Southeast	9 - 10	Asia-Pacific - Latin America	13 - 2
District 57 - Southwest	13 - 5	Latin America - Portoriko	1 - 2
East - Australia	12 - 1	West - Europ-Africa	13 - 2
semifinále / semi finals	Asia-Pacific 14 - 3	Portoriko	
	District 57 5 - 1	Southeast	
finále / final	Asia-Pacific 10 - 0	District 57	

Týmy / Teams

Asia-Pacific = Soul, South Korea

Kanada = Coquitlam/Surrey BC

Europe-Africa = South, Czechia

Latin America = Guadalupe Trevino, Mexico

Portoriko = Cuayama, Portoriko

Australia = Northern Metros, Perth



East = Commack, NY



Southeast = West Boynton Beach, Florida



Central = Ankeny, Iowa



Southwest = Midland, Texas



West = San Diego, California



District 57 = Livermore Baseball LL



Evropská kvalifikace PONY LEAGUE 2018 U14, Česká republika
European PONY LEAGUE 2018 U14, Czech Republic



A	Netherlands A	Prague	KMC	Israel B	Stars	W	-	L
Nizozemsko U14 A	24 - 0		6 - 4	21 - 1	35 - 0	4	-	0
Tým Prahy	0 - 24		1 - 0	10 - 6	7 - 6	3	-	1
KMC Ambassadors (GER)	4 - 6	0 - 1		12 - 5	16 - 1	2		2
Izrael B	1 - 21	6 - 10	5 - 12		29 - 1	1		3
North Stars (RUS)	0 - 35	6 - 7	1 - 16	1 - 29		0	-	4

B	Czech Ac	Moskvich	Gava	Brest	Sports	W	-	L
Česká Akademie	8 - 1		15 - 0	21 - 2	24 - 0	4	-	0
Moskvich	1 - 8		9 - 7	11 - 7	9 - 6	3		1
Gava (ESP)	0 - 15	7 - 9		6 - 1	7 - 5	2		2
Brest Zubrs (BLR)	2 - 21	7 - 11	1 - 6		14 - 2	1	-	3
London Sports	0 - 24	6 - 9	5 - 7	2 - 14		0	-	4

C	German Ac	Austrian Ac	Israel B	Mets	Kaunas	W	-	L
Německá Akademie	10 - 3		31 - 0	20 - 0	34 - 0	4	-	0
Rakouská Akademie	3 - 10		9 - 1	12 - 0	11 - 1	3	-	1
Izrael A	0 - 31	1 - 9		13 - 2	9 - 8	2	-	2
London Mets	0 - 20	0 - 12	2 - 13		17 - 5	1		3
Kaunas	0 - 34	1 - 11	8 - 9	5 - 17		0	-	4

D	Bordeaux Ac	Archers	Netherlands B	Vilnius	Ukraine	W	-	L
Akademie Bordeaux	4 - 5		7 - 6	16 - 6	25 - 1	3	-	1
London Archers	5 - 4		1 - 11	19 - 0	20 - 0	3	-	1
Nizozemsko U14 B	6 - 7	11 - 1		9 - 3	18 - 10	3	-	1
Vilnius BC	6 - 16	0 - 19	3 - 9		14 - 12	1		3
Pony Ukraine	1 - 25	0 - 20	10 - 18	12 - 14		0	-	4

čtvrtfinále / quarter finals

Netherlands A	8 - 7	Bordeaux Academy
Czech Academy	5 - 8	Austrian Academy
German Academy	16 - 0	Moskvich
Netherlands B	10 - 0	Prague Team

o 17.-20. místo / for 17th-20th place

North stars	9 - 12	London Sports
Kaunas	12 - 0	PONY Ukraine

o 13.-16. místo / for 13th-16th place

Izrael B	2 - 5	Brest Zubrs
London Mets	12 - 9	Vilnius BC

o 9.-12. místo / for 9th-12th place

KMC Ambassadorst	10 - 4	Gava
Izrael A	8 - 7	London Archers

o 5.-8. místo / for 5th-8th place

Bordeaux Academy	7 - 1	Czech Academy
Moskvich	11 - 10	Prague Team

Evropská kvalifikace PONY LEAGUE 2018 U14, Česká republika
European PONY LEAGUE 2018 U14, Czech Republic



semifinále / semi finals

Netherlands A 7 - 0 Netherlands B
 German Academy 11 - 1 Austrian Academy

o 19. místo / for 19th place

North stars 12 - 4 PONY Ukrajina

o 17. místo / for 17th place

London Sports 6 - 9 Kaunas

o 15. místo / for 15th place

Israel B 7 - 8 Vilnius BC

o 13. místo / for 13th place

Brest Zubrs 1 - 16 London Mets

o 11. místo / for 11th place

Gava 1 - 13 London Archers

o 9. místo / for 9th place

KMC 4 - 0 Israel A

o 7. místo / for 7th place

Czech Academy 7 - 8 Prague Team

o 5. místo / for 5th place

Bordeaux Academy 5 - 6 Moskvich

o 3. místo / for 3rd place

Netherlands B 6 - 10 Austrian Academy

finále / final

Netherlands A 11 - 7 German Academy

Nizozemsko U14 A	1	<i>Netherlands U14 A</i>	London Archers	11	<i>London Archers</i>
Německá Akademie	2	<i>German Academy</i>	Gava	12	<i>Gava</i>
Rakouská Akademie	3	<i>Austrian Academy</i>	London Mets	13	<i>London Mets</i>
Nizozemsko U14 B	4	<i>Netherlands U14 B</i>	Brest Zubrs	14	<i>Brest Zubrs</i>
Akademie Bordeaux	5	<i>Bordeaux Academy</i>	Vilnius BC	15	<i>Vilnius BC</i>
Moskvich	6	<i>Moskvich</i>	Izrael B	16	<i>Israel B</i>
Česká Akademie	7	<i>Czech Academy</i>	Kaunas	17	<i>Kaunas</i>
Tým Prahy	8	<i>Prague Team</i>	London Sports	18	<i>London Sports</i>
KMC Ambassadors	9	<i>KMC Ambassadors</i>	North stars	19	<i>North Stars</i>
Izrael A	10	<i>Israel A</i>	Pony Ukraine	20	<i>Pony Ukraine</i>

Evropská kvalifikace PONY LEAGUE 2017 U16, Česká republika
European PONY LEAGUE 2017 U16, Czech Republic



A	Netherlands A	Israel	Prague	Catalonia	Tigers	W - L
Nizozemsko A	5 - 1		22 - 1	8 - 2	12 - 6	4 - 0
Izrael	1 - 5		8 - 0	9 - 1	17 - 2	3 - 1
Tým Prahy	1 - 22	0 - 8		5 - 4	5 - 3	2 - 2
Catalonia (SPA)	2 - 8	1 - 9	4 - 5		5 - 1	1 - 3
Tigers of Balashika (RUS)	6 - 12	2 - 17	3 - 5	1 - 5		0 - 4

B	Neptunus	Hroši	Bordeaux	Troops	Cardinals	W - L
Team Neptunus (NED)	9 - 5		10 - 0	22 - 0	12 - 1	4 - 0
Hroši Brno	5 - 9		2 - 5	25 - 0	23 - 14	3 - 1
Akademie Bordeaux	0 - 10	5 - 2		16 - 8	6 - 5	2 - 2
Diamond Troops (UKR)	0 - 22	0 - 25	8 - 16		19 - 8	1 - 3
Moscow Cardinals (RUS)	1 - 12	14 - 23	5 - 6	8 - 19		0 - 4

C	Czech Ac	Twins	Ukraine	Slovakia	Stuttgart	W - L
Česká Akademie	5 - 1		7 - 2	11 - 0	-	3 - 0
Oosterhout Twins (NED)	1 - 5		24 - 0	27 - 1	-	2 - 1
Pony Ukrajina	2 - 7	0 - 24		12 - 4	-	1 - 2
Slovensko	0 - 11	1 - 27	4 - 12		-	0 - 3
Stuttgart Reds (GER)	-	-	-			

D	Austria Ac.	Netherlands B	Czechia 15	Indiana	Serbia	W - L
Rakouská Akademie	9 - 8		7 - 6	7 - 4	17 - 5	4 - 0
Nizozemsko B	8 - 9		12 - 0	5 - 2	27 - 3	3 - 1
Česko U15	6 - 7	0 - 12		15 - 6	8 - 5	2 - 2
Indians (FRA)	4 - 7	2 - 5	6 - 15		8 - 7	1 - 3
Srbsko	5 - 17	3 - 27	5 - 8	7 - 8		0 - 4

čtvrtfinále / quarter finals

Nizozemsko A	15 - 3	Nizozemsko B
Česká akademie	10 - 3	Hroši Brno
Team Neptunus	7 - 4	Oosterhout Twins
Rakouská akademie	7 - 3	Izrael

o 17.-20. místo / for 17th-20th place

Tigers of Balashika	5 - 13	Moscow Cardinals
Srbsko	<i>zrušeno</i>	Stuttgart Reds

o 13.-16. místo / for 13th-16th place

Slovensko	2 - 5	Indians
Catalonia	11 - 2	Diamond troops

o 9.-12. místo / for 9th-12th place

Pony Ukrajina	2 - 14	Česko U15
Tým Prahy	6 - 4	Akademie Bordeaux

o 5.-8. místo / for 5th-8th place

Hroši Brno	2 - 19	Izrael
Nizozemsko B	3 - 9	Oosterhout Twins

Evropská kvalifikace PONY LEAGUE 2017 U16, Česká republika
European PONY LEAGUE 2017 U16, Czech Republic



semifinále / <i>semi finals</i>	Nizozemsko A	11	-	1	Rakouská akademie
	Česká akademie	7	-	2	Team Neptunus
o 17. místo / <i>for 17th place</i>	Moscow Cardinals	6	-	9	Srbsko
o 15. místo / <i>for 15th place</i>	Diamond troops	5	-	8	Slovensko
o 13. místo / <i>for 13th place</i>	Prague team	4	-	11	Swiss NT
o 11. místo / <i>for 11th place</i>	Alligators	0	-	16	Serbia
o 9. místo / <i>for 9th place</i>	Tým Prahy	8	-	5	Česko U15
o 7. místo / <i>for 7th place</i>	Nizozemsko B	11	-	3	Hroši Brno
o 5. místo / <i>for 5th place</i>	Oosterhout Twins	1	-	7	Izrael
o 3. místo / <i>for 3rd place</i>	Rakouská akademie	13	-	12	Team Neptunus
finále / <i>final</i>	Nizozemsko A	11	-	0	Česká akademie

Nizozemsko A	1	<i>Netherlands A</i>	Akademie Bordeaux	11	<i>Bordeaux Academy</i>
Česká akademie	2	<i>Czech Academy</i>	Pony Ukrajina	12	<i>Pony Ukraine</i>
Rakouská akademie	3	<i>Austrian Academy</i>	Indians	13	<i>Indians</i>
Team Neptunus	4	<i>Team Neptunus</i>	Catalonia	14	<i>Catalonia</i>
Izrael	5	<i>Israel</i>	Slovensko	15	<i>Slovakia</i>
Oosterhout Twins	6	<i>Oosterhout Twins</i>	Diamond troops	16	<i>Diamond Troops</i>
Nizozemsko B	7	<i>Netherlands B</i>	Srbsko	17	<i>Serbia</i>
Hroši Brno	8	<i>Hroši Brno</i>	Moscow Cardinals	18	<i>Moscow Cardinals</i>
Tým Prahy	9	<i>Prague Team</i>	Tigers of Balashika	19	<i>Tigers of Balashika</i>
Česko U15	10	<i>Czechia U15</i>	Suttgart Reds	20	<i>Stuttgart Reds</i>

Perfect Game U12, Brno - Česko
Perfect Game U12, Brno - Czechia



PERFECT GAME

	<i>Czech Ac</i>	<i>National U12</i>	<i>LL South</i>	<i>Hroši Brno</i>	<i>Austrian Ac</i>	<i>Regensburg</i>	W - L
Česká akademie		9 - 8	5 - 2	17 - 0		9 - 0	4 - 0
Reprezentace U12	8 - 9			17 - 1	9 - 1	20 - 0	3 - 1
LL region Jih	2 - 5			9 - 8	18 - 2	19 - 6	3 - 1
Hroši Brno	0 - 17	1 - 17	8 - 9		9 - 7		1 - 3
Rakouská akademie		1 - 9	2 - 18	7 - 9		13 - 4	1 - 3
Regensburg	0 - 9	0 - 20	6 - 19		4 - 13		0 # 4

o 5. místo / *for 5th place*
o 3. místo / *for 3rd place*
finále / *final*

Austrian Academy 4 - 2 Regensburg Team
LL Region South 4 - 3 Hroši Brno
Czech Academy 3 - 1 National Team U12

Česká akademie	1	<i>Czech Academy</i>
Reprezentace U12	2	<i>National Team U12</i>
LL Region Jih	3	<i>LL Region South</i>
Hroši Brno	4	<i>Hroši Brno</i>
Rakouská akademie	5	<i>Austrian Academy</i>
Tým Regensburg	6	<i>Regensburg Team</i>

Perfect Game U15, Brno - Česko
Perfect Game U15, Brno - Czechia



PERFECT GAME

	<i>Czech Ac</i>	<i>KMC</i>	<i>National U15</i>	<i>AS Europe</i>	<i>Prague Ac</i>	<i>AS E.Europe</i>	W - L
Česká akademie		13 - 2	1 - 1	9 - 6	7 - 0		4 - 0
KMC Ambassadors	2 - 13			13 - 3	10 - 5	20 - 5	3 - 1
Reprezentace U15	1 - 1			0 - 13	8 - 1	15 - 4	3 - 1
All Star Evropa	6 - 9	3 - 13	0 - 13			10 - 0	1 - 3
Akademie Praha	0 - 7	5 - 10	1 - 8			10 - 2	1 - 3
All Star vých. Evropa		5 - 20	4 - 15	0 - 10	2 - 10		0 - 4

o 5. místo / *for 5th place*
o 3. místo / *for 3rd place*
finále / *final*

Prague Academy 6 - 9 Eastern Europe All Star
National Team U15 5 - 1 Europe All Star
Czech Academy 6 - 0 KMC Ambassadors

Česká akademie	1	<i>Czech Academy</i>
KMC Ambassadors	2	<i>KMC Ambassadors</i>
Reprezentace U15	3	<i>National Team U15</i>
All Star Evropa	4	<i>Europe All Star</i>
All Star východní Evropa	5	<i>Eastern Europe All Star</i>
Akademie Praha	6	<i>Prague Academy</i>

Major League Baseball 2018



Americká liga *American League*

	W	L	PCT
Východ			
Boston Red Sox	108	54	667
NY Yankees	100	62	617
Tampa Bay	90	72	556
Toronto Blue Jays	73	89	451
Baltimore Orioles	47	115	290
Střed			
Cleveland Indians	91	71	562
Minnesota Twins	78	84	481
Detroit Tigers	64	98	395
Chicago White Sox	62	100	383
Kansas City Royals	58	104	358
Západ			
Houston Astros	103	59	636
Oakland Athletics	97	65	599
Seattle Mariners	89	73	549
Los Angeles Angels	80	82	494
Texas Rangers	67	95	414
Wild Game			
NY Yankees	7		1
Oakland Athletics	2		0

Národní liga *National League*

	W	L	PCT
East			
Atlanta Braves	90	72	556
Washington Nationals	82	80	506
Philadelphia Phillies	80	82	494
New York Mets	77	85	475
Miami Marlins	63	98	391
Central			
Milwaukee Brewers	96	67	589
Chicago Cubs	95	68	583
St. Louis Cardinals	88	74	543
Pittsburgh Pirates	82	79	509
Cincinnati Reds	67	95	414
West			
Los Angeles Dodgers	92	71	564
Colorado Rockies	91	72	558
Arizona Diamondbacks	82	80	506
San Francisco Giants	73	89	451
San Diego Padres	66	96	407
Wild Game			
Chicago Cubs	1		0
Colorado Rockies	2		1

čtvrtfinále *Division Series*

Boston Red Sox	5	2	16	4	3
New York Yankees	4	6	1	3	1
Houston Astros	7	3	11	3	3
Cleveland Indians	2	1	3	0	0
Milwaukee Brewers	3	4	6	3	3
Colorado Rockies	2	0	0	0	0
Los Angeles Dodgers	6	3	5	6	3
Atlanta Braves	0	0	6	2	1

semifinále *League Championship Series*

Boston Red Sox	2	7	8	8	4	4
Houston Astros	7	5	2	6	1	1
Milwaukee Brewers	6	3	4	1	2	7
Los Angeles Dodgers	5	4	0	2	5	2

Světová série *World Series*

Boston Red Sox	8	4	2	6	5	4
Los Angeles Dodgers	4	2	3	1	1	1



Televizní přenosy v roce 2018

Baseball Broadcasted in Czech TV

ČESKÁ TELEVIZE

www.ceskatelevize.cz

SuperCup

záznam z turnaje *summary of the tournament*

Téma pro hosty / *Theme for guests*

Cal Ripken *rozhovor / interview*

Super Six

Česko - Nizozemsko *přímý přenos utkání / live stream*
Česko - Španělsko *přímý přenos utkání / live stream*
Česko - Itálie *přímý přenos utkání / live stream*
Česko - Německo *přímý přenos utkání / live stream*

PLAYO-TV

www.playo.tv

Super Six

Belgie - Ukrajina *přímý přenos utkání / live stream*
Česko - Litva *přímý přenos utkání / live stream*
Rusko - Nizozemsko *přímý přenos utkání / live stream*
Česko - Ukrajina *přímý přenos utkání / live stream*
Rusko - Bělorusko *přímý přenos utkání / live stream*
Česko - Belgie *přímý přenos utkání / live stream*
Polsko - Slovensko *přímý přenos utkání / live stream*
Nizozemsko - Velká Británie *přímý přenos utkání / live stream*
Česko - Francie *přímý přenos utkání / live stream*
Německo - Velká Británie *přímý přenos utkání / live stream*
Belgie - Nizozemsko *přímý přenos utkání / live stream*
Česko - Španělsko *přímý přenos utkání / live stream*
Německo - Francie *přímý přenos utkání / live stream*
Španělsko - Belgie *přímý přenos utkání / live stream*
Česko - Nizozemsko *přímý přenos utkání / live stream*

Czech Series, Extra League 2018

Draci Brno - Arrows Ostrava *přímý přenos utkání / live stream*
Draci Brno - Arrows Ostrava *přímý přenos utkání / live stream*
Arrows Ostrava - Draci Brno *přímý přenos utkání / live stream*
Arrows Ostrava - Draci Brno *přímý přenos utkání / live stream*

Registrovaní členové ČBA podle Regionů 2018
Registered members of CBA 2018

Oddíl <i>Club</i>	19+ (19+)	U18 (17-18)	U16 (15-16)	U14 (13-14)	U12 (11-12)	U10 (-10)	celkem <i>total</i>	%	2017	rozdíl <i>difference</i>
Baryba Velký Osek	2	-	-	-	5	27	34	0,44	32	+ 2
Céčko Praha	14	-	-	-	-	-	14	0,18	-	+ 14
Eagles Praha	56	12	18	23	34	127	270	3,50	244	+ 26
Fulleros de la Habana	41	-	-	-	-	-	41	0,53	38	+ 3
Joudrs Praha	13	1	2	26	39	47	128	1,66	45	+ 83
Kotlářka Praha	107	21	21	6	14	31	200	2,59	197	+ 3
Lokomotiva Louny	25	4	5	8	2	2	46	0,60	47	- 1
Miners Kladno	21	5	10	16	17	60	129	1,67	133	- 4
Old Boys Praha	24	-	-	-	-	-	24	0,31	25	- 1
Piranhas Beroun	20	-	-	-	29	42	91	1,18	79	+ 12
Praotci Roudnice	15	-	6	2	5	7	35	0,45	42	- 7
Rakovník Red Crayfish	18	-	5	9	9	20	61	0,79	60	+ 1
SaBaT Praha	47	5	20	23	28	48	171	2,21	153	+ 18
SK Kotlářka Praha	32	18	11	32	26	2	121	1,57	118	+ 3
Tempo Titans Praha	62	8	9	22	34	80	215	2,78	260	- 45
Vlaštovky Sadská	1	-	-	-	-	20	21	0,27	-	+ 21
<i>Severozápad</i>	481	74	107	167	242	513	1 601	20,74	1 473	+ 128
<i>North-West (%)</i>	(30%)	(5%)	(7%)	(10%)	(15%)	(32%)				
Baseball Plzeň	12	1	-	4	20	60	97	1,26	87	+ 10
Borek Giants	-	-	-	-	3	10	13	0,17	23	- 10
Klatovy Brewers	3	-	-	-	15	26	44	0,57	37	+ 7
Májští sršni Č.B.	-	-	4	6	12	22	44	0,57	55	- 11
Pigs Trhové Sviny	4	-	1	1	-	21	27	0,35	38	- 11
Sharks Spálené Poříčí	21	3	2	6	3	-	35	0,45	53	- 18
Slavia VŠ Plzeň	-	-	-	-	-	-	-	-	31	- 31
Sokol Hluboká n.V.	131	36	50	40	45	96	398	5,15	514	- 116
Wolfs Domažlice	61	4	11	6	13	23	118	1,53	237	- 119
Žraloci Ledenice	1	-	-	-	-	13	14	0,18	20	- 6
<i>Jihozápad</i>	233	44	68	63	111	271	790	10,23	1 095	- 305
<i>South-West (%)</i>	(29%)	(6%)	(9%)	(8%)	(14%)	(34%)				
Blesk Jablonec n.N.	76	1	4	7	23	39	150	1,94	152	- 2
Bongo Liberec	17	-	-	-	-	-	17	0,22	-	+ 17
Meteors Žamberk	-	-	-	-	-	-	-	-	51	- 51
Orlí Choceň	171	15	8	13	19	44	270	3,50	247	+ 23
Patriots Liberec	15	8	9	20	16	26	94	1,22	96	- 2
Piráti Žacléř	3	-	-	3	1	6	13	0,17	17	- 4
Rytíři Trutnov	19	3	3	5	14	41	85	1,10	80	+ 5
SB Svoboda n. Úpou	13	-	-	-	-	-	13	0,17	13	0
SK Klackaři Kostelec	2	-	-	-	-	20	22	0,28	18	+ 4
Sparks Mladé Buky	5	2	-	1	3	-	11	0,14	13	- 2
Spartak Trutnov	12	-	-	-	-	1	13	0,17	14	- 1
Waynes Pardubice	9	-	5	10	17	41	82	1,06	65	+ 17
<i>Severovýchod</i>	342	29	29	59	93	218	770	9,97	766	+ 4
<i>North-East (%)</i>	(44%)	(4%)	(4%)	(8%)	(12%)	(28%)				

Registrovaní členové ČBA podle Regionů 2018
Registered members of CBA 2018

Oddíl <i>Club</i>	19+ (19+)	U18 (17-18)	U16 (15-16)	U14 (13-14)	U12 (11-12)	U10 (-10)	celkem <i>total</i>	%	2017	rozdíl <i>difference</i>
Aligátoři Znojmo	20	-	1	2	3	4	30	0,39	-	+ 30
CLUBS Kyjov	-	-	-	-	-	-	-	-	1	- 1
Draci Brno	320	73	69	30	41	116	649	8,41	627	+ 22
Foxes Brno	12	-	-	-	-	-	12	0,16	-	+ 12
Hroši Brno	186	26	23	43	42	57	377	4,88	335	+ 42
Hroch z.s.	-	-	-	-	-	110	110	1,42	46	+ 64
Ježci Jihlava	25	-	-	-	7	82	114	1,48	62	+ 52
Oilers Hodonín	6	1	-	2	15	41	65	0,84	64	+ 1
Olympia Blansko	383	31	36	56	50	117	673	8,72	394	+ 279
Pelikans Bučovice	32	1	3	6	11	29	82	1,06	83	- 1
Pipas Brno	2	-	-	-	-	42	44	0,57	61	- 17
Sokol Bedřichov	-	-	-	-	-	-	-	-	13	- 13
Technika Brno	114	15	16	16	26	28	215	2,78	282	- 67
Třebíč Nuclears	398	85	55	76	67	130	811	10,50	757	+ 54
<i>Jih</i>	1 498	232	203	231	262	756	3 182	41,21	2 725	+ 457
<i>South (%)</i>	(47%)	(7%)	(6%)	(7%)	(8%)	(24%)				
Arrows Ostrava	350	27	32	37	36	47	529	6,85	473	+ 56
Cannibals Šumperk	20	2	-	8	7	16	53	0,69	44	+ 9
Cobblers Zlín	4	4	7	5	10	2	32	0,41	28	+ 4
HIT Opava	17	-	3	5	13	78	116	1,50	86	+ 30
Klasik Frýdek-Místek	224	37	45	22	24	43	395	5,12	383	+ 12
MSK Snails Orlová	24	-	-	-	-	-	24	0,31	16	+ 8
Skokani Olomouc	77	2	9	19	12	28	147	1,90	146	+ 1
<i>Východ</i>	716	72	96	96	102	214	1 296	16,79	1 176	+ 120
<i>East (%)</i>	(55%)	(6%)	(7%)	(7%)	(8%)	(17%)				
individuální členové	81	-	1	-	-	-	82	1,06	80	+ 2
<i>individual members (%)</i>	(99%)	(0%)	(1%)	(0%)	(0%)	(0%)				
Česká republika	3 351	451	504	616	810	1 972	7 721	100,00	7 339	+ 382
<i>Czech Republic (%)</i>	(43%)	(6%)	(7%)	(8%)	(10%)	(26%)				